

○ Avec ou sans mécanique
With or without mechanical elements
Con o senza parti meccaniche
Mit oder ohne Aggregate
Con ó sin mecanica desmontada

REP.	REFERENCE	PDS	NB	MZ
1	898.7001	0,1	2	
2	898.7002	2,7	1	142
3	898.7003	2,7	1	141
4	898.7004	2,5	1	200/080
5	898.7005	2,5	1	200/080
6	898.7006	0,2	2	
7	898.7007	3,8	1	601
8	898.7008	3,8	1	602
9	898.7009	0,9	2	
10	898.7010	1,9	1	140/080
11	898.7011	1,9	1	140/080
12	898.7012	1,8	1	080
13	898.7013	1,8	1	080
14	898.7014	2,7	1	080
15	898.7015	2,7	1	080
16	898.7016	0,9	1	
17	898.7017	0,9	1	
18	898.7018	0,9	1	
19	898.7019	0,9	1	
20	898.7020	2,5	1	260
21	898.7021	2,5	1	260
22	898.7022	2,9	1	602
23	898.7023	2,9	1	601
24	898.7024	2,7	1	260
25	898.7025	2,7	1	260
26	898.7026	2,0	1	200
27	898.7027	2,2	1	200
	V32	0,1	2	
	E22	0,1	2	

M 8-20	6
M 12-20	6
M 12-25	8
M 12-30	2
M 12x1,25-70	4
M 12x1,25-130	2
M 16x1,50-30	2
M 16x1,50-60	2
M 16x1,50-150	2
M 16x1,50-170	2

TOYOTA / LEXUS / DAIHATSU

898.300

59 Kg 24.02.2003 434-D-77A

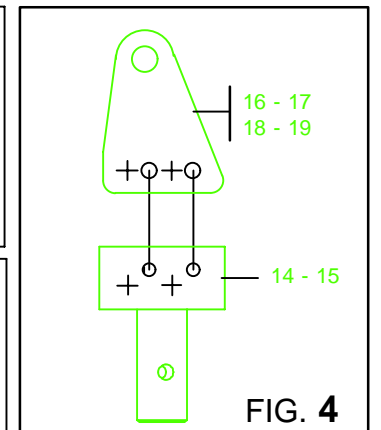
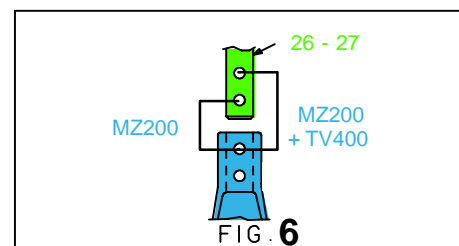
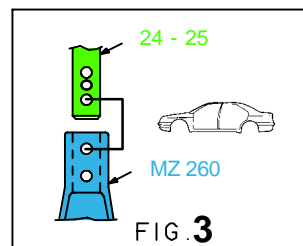
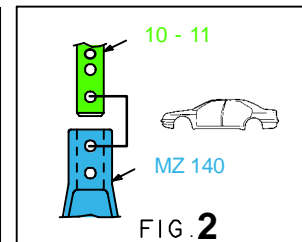
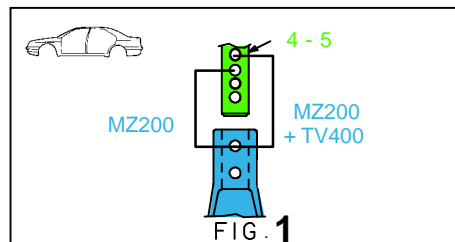
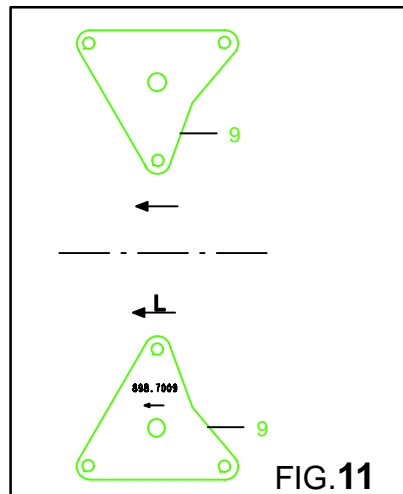
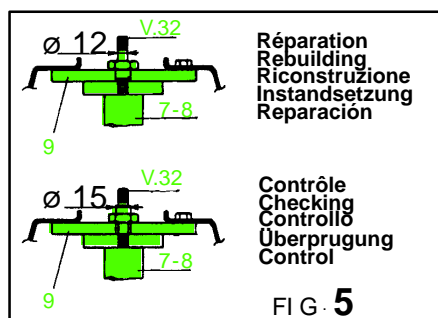
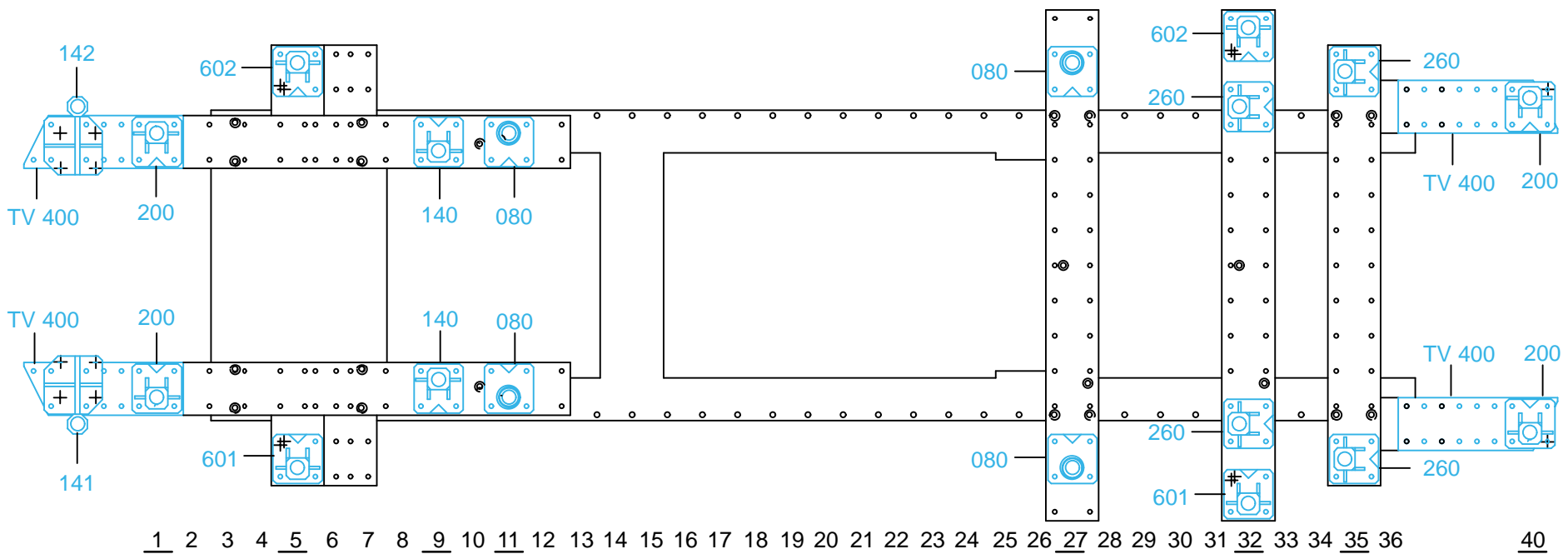

898.300-RVA3-1 02

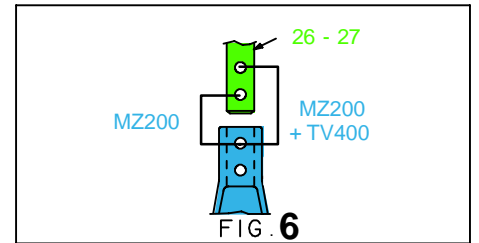
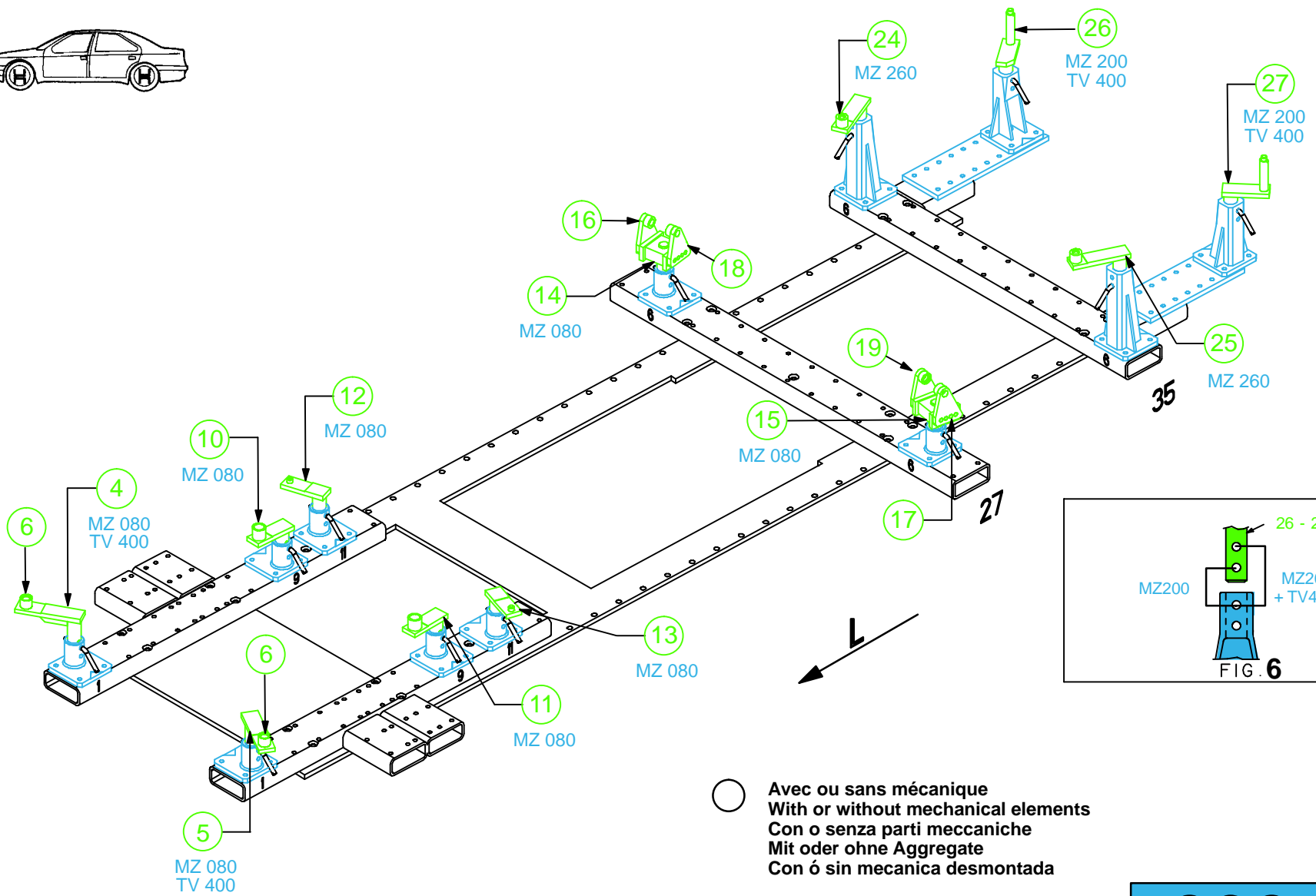

○ Avec ou sans mécanique
 With or without mechanical elements
 Con o senza parti meccaniche
 Mit oder ohne Aggregate
 Con ó sin mecanica desmontada

TOYOTA / LEXUS / DAIHATSU

898.300

59 Kg | 24.02.2003 | 434-D-77B

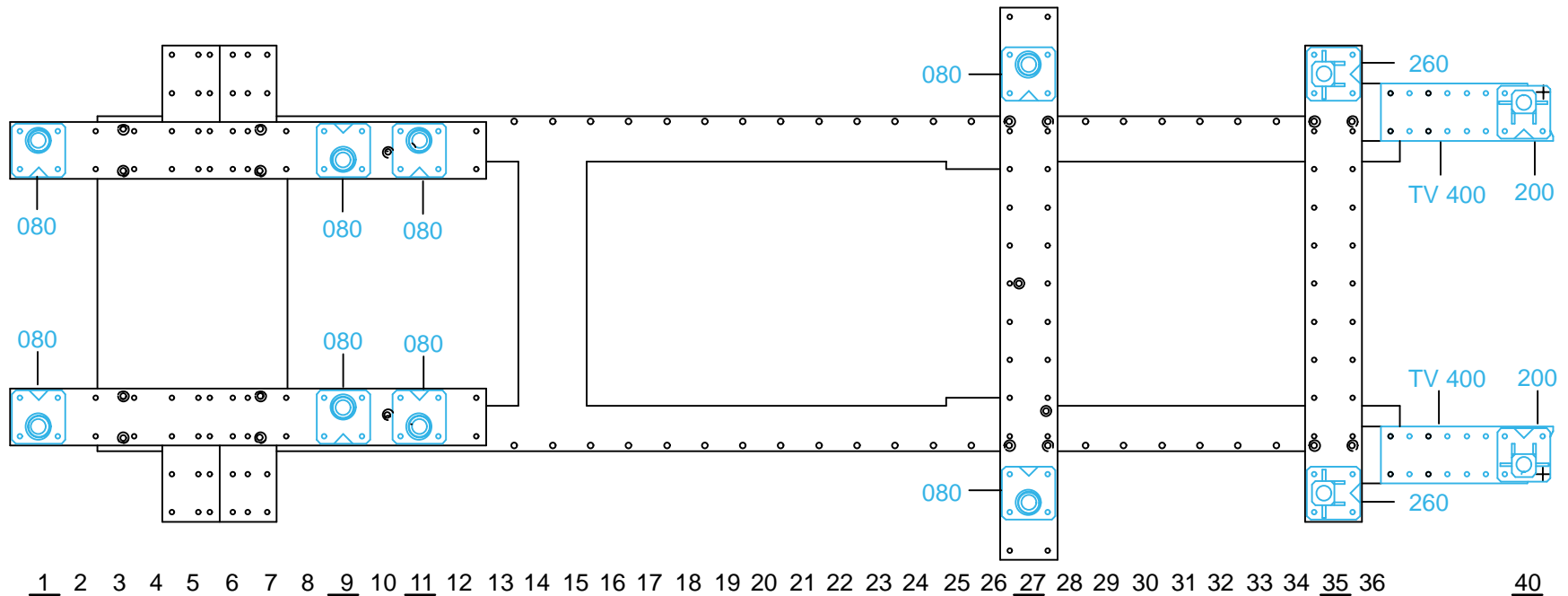

1 2 3 4 5 6 7 8 9 10 11 12 13 14 15 16 17 18 19 20 21 22 23 24 25 26 27 28 29 30 31 32 33 34 35 36 40

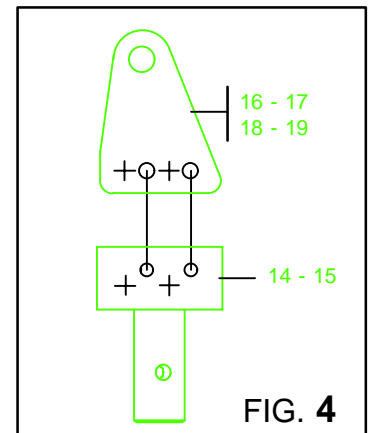
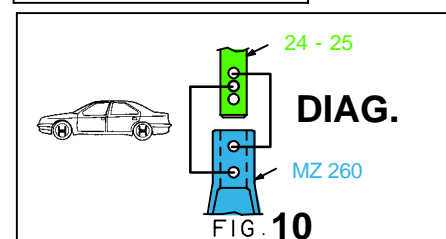
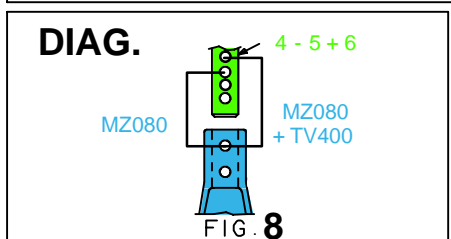
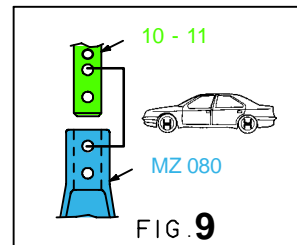
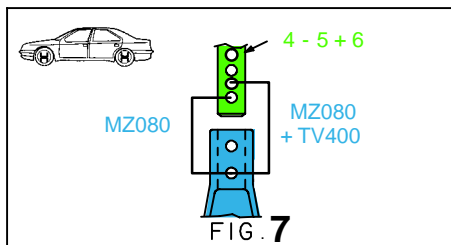
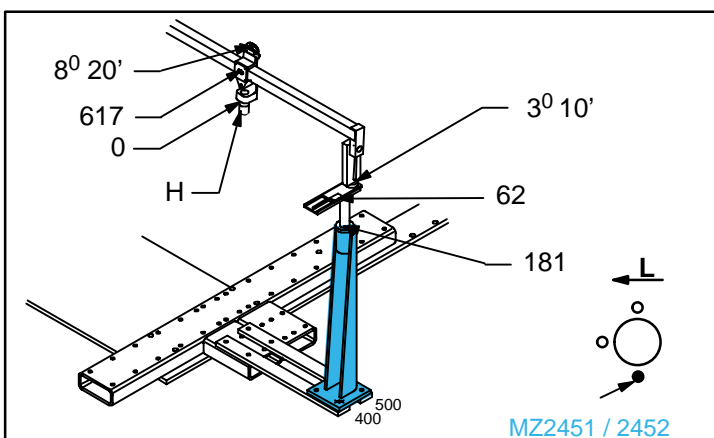

898.300-RVA3-1 | 02