

○ Avec ou sans mécanique
 With or without mechanical elements
 Con o senza parti meccaniche
 Mit oder ohne Aggregate
 Con ó sin mecanica desmontada

NISSAN

REP.	REFERENCE	PDS	NB	MZ
25	889.7025	2,8	1	080
26	889.7026	2,8	1	080
27	889.7027	1,0	1	
28	889.7028	1,0	1	
29	889.7029	1,6	1	140
30	889.7030	1,6	1	140
31	889.7031	1,0	4	
32	889.7032	2,2	1	602
33	889.7033	2,2	1	601
34	889.7034	0,6	2	
35	889.7035	1,9	1	200/140
36	889.7036	1,9	1	200/140
37	889.7037	0,6	2	
38	889.7038	0,3	2	
	E27	0,1	2	

	M 12-30 M 12x1,25-25	6 4
	M 10	2
	LU 12	4

complément au
 complementary set to
 complemento al
 zusatz zu **889.300**

889.309

27 Kg 19.09.2002 410-D-66C

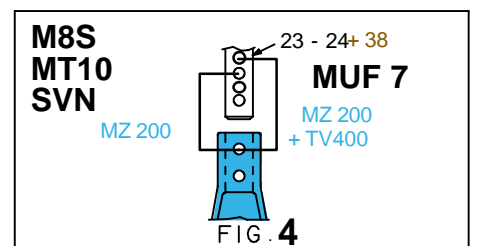
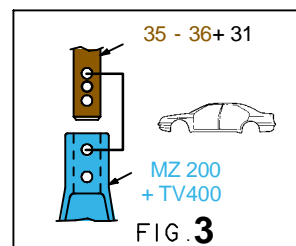
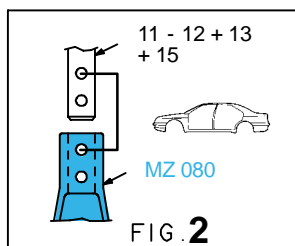
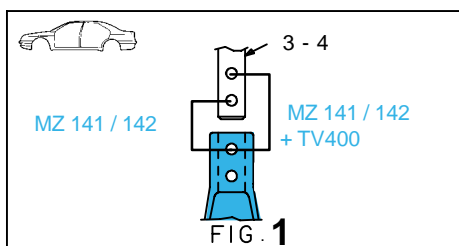
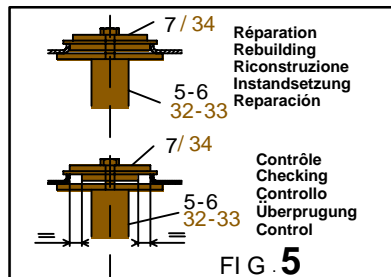
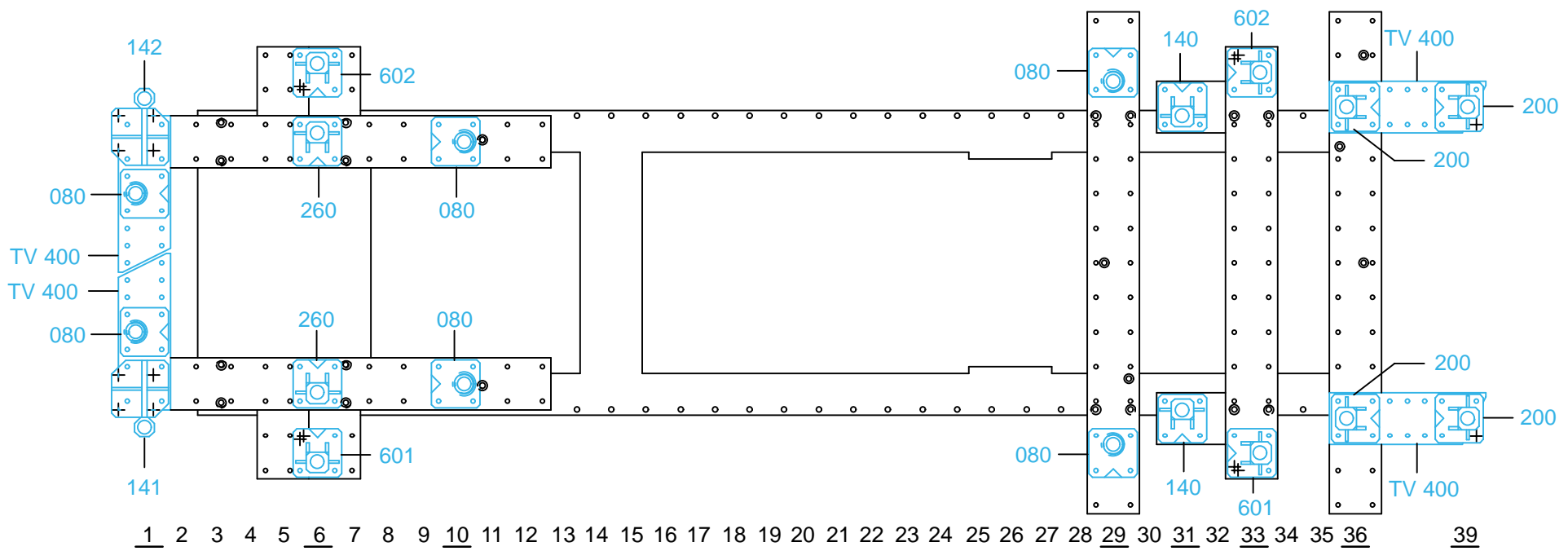

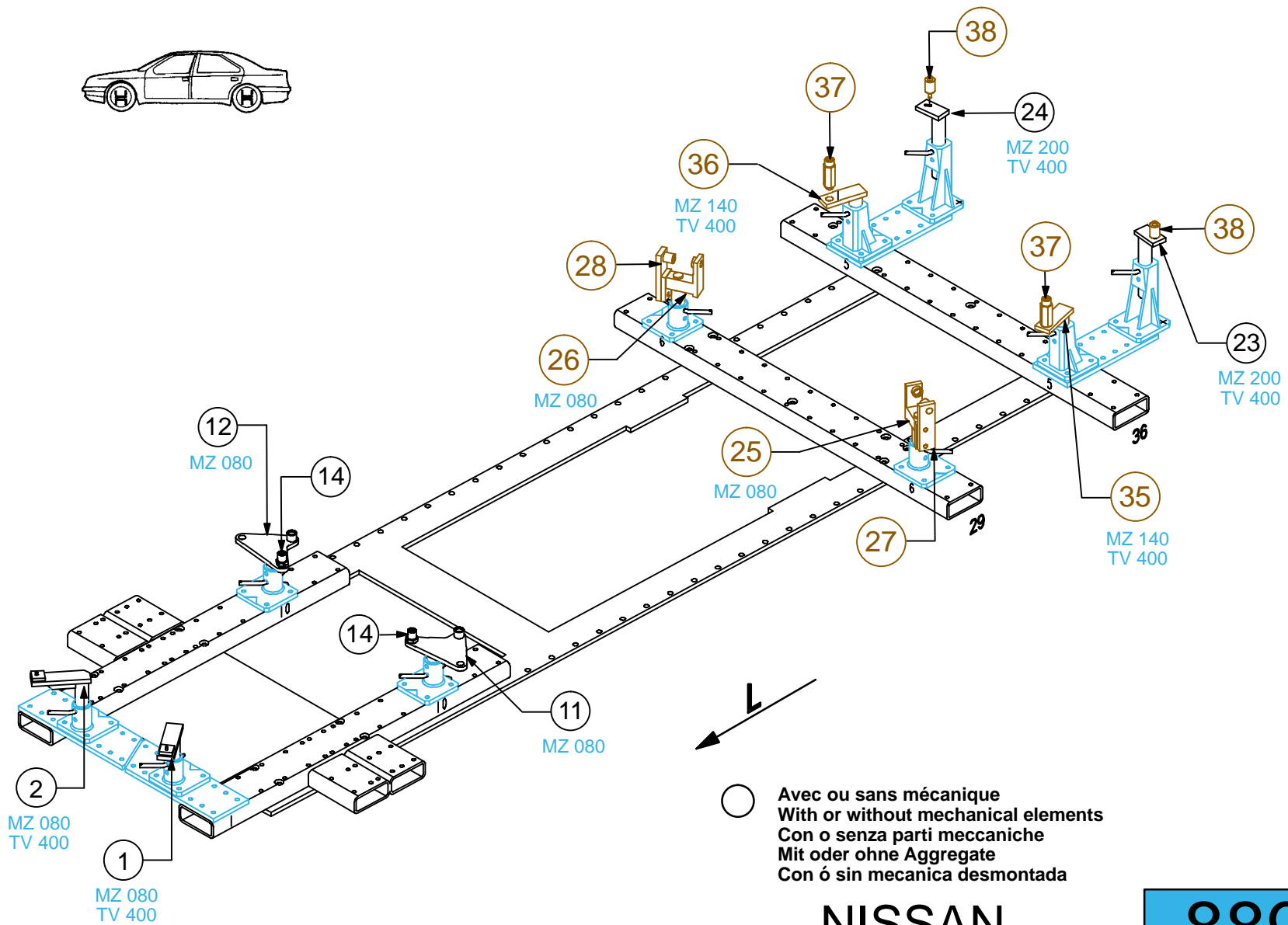
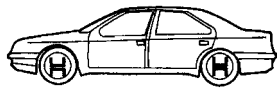

NISSAN

889.309

27 Kg | 19.09.2002 | 410-D-66D

