

○ Avec ou sans mécanique  
With or without mechanical elements  
Con o senza parti meccaniche  
Mit oder ohne Aggregate  
Con ó sin mecanica desmontada

**HONDA**

REP.	REFERENCE	PDS	NB	MZ
3	873.7003	1,9	1	140/080
4	873.7004	1,9	1	140/080
5	873.7005	3,7	1	260
6	873.7006	3,7	1	260
7	873.7007	3,2	1	601
8	873.7008	3,2	1	602
9	873.7009	1,7	1	140/080
10	873.7010	1,7	1	140/080
11	873.7011	2,2	1	080
12	873.7012	2,2	1	080
13	873.7013	1,7	1	140
14	873.7014	1,7	1	140
15	873.7015	2,7	1	142
16	873.7016	2,7	1	141
17	873.7017	2,8	1	200
18	873.7018	2,8	1	200
19	873.7019	2,7	2	260
20	873.7020	2,2	1	080
21	873.7021	2,2	1	080
22	873.7022	2,4	1	260
23	873.7023	2,4	1	260
24	873.7024	4,8	2	260
25	873.7025	3,2	2	260
	D.078	0,5	2	
	T034	0,08	2	
	T039	0,03	2	

M 8-30	6
M 10-30	4
M 12-25	8
M 12-30	2
M 12x1,25-45	4
M 12x1,25-70	4
M 12x1,25-100	2
M 14x1,50-100	2
M 14x1,50-110	2
M 14x1,50-140	2
M 14x1,50-150	2
TFHc 16-50	6
CHc 12-25 TB	4
955714	10

M 10	4
------	---

**873.300**

74 Kg 31.05.2001 413-D-36A

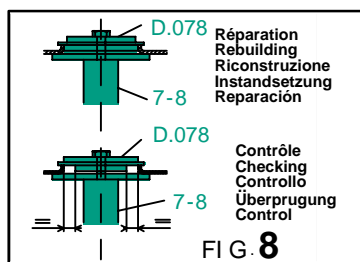
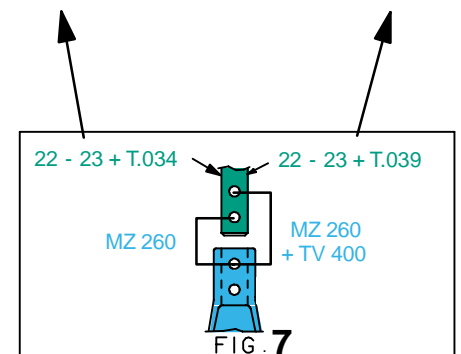
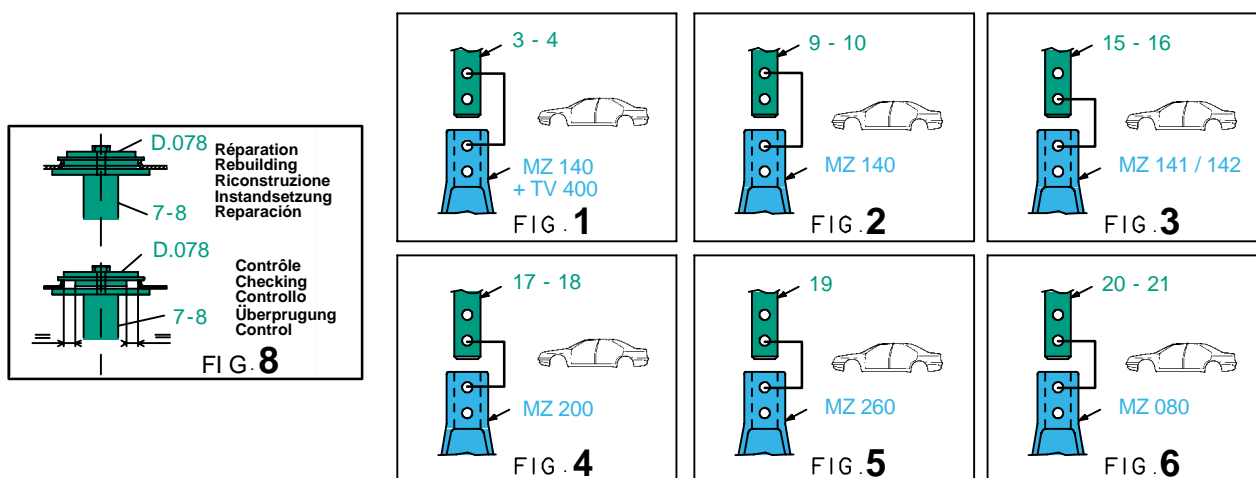
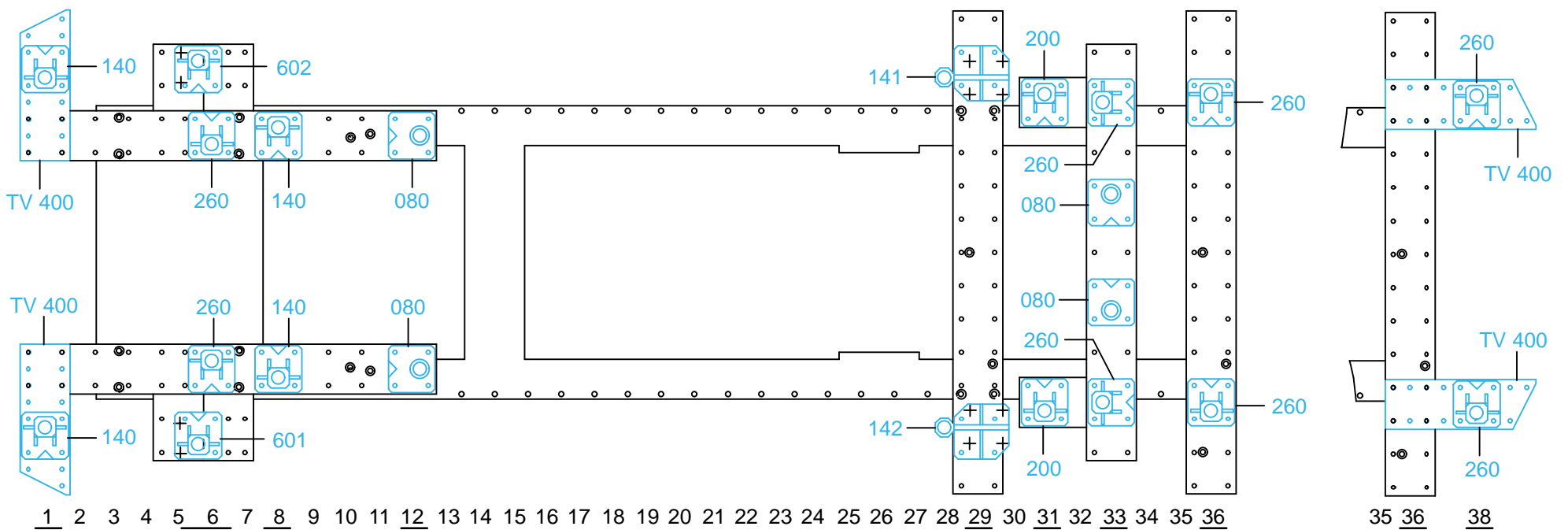

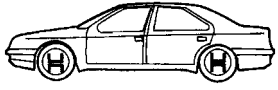

**CIVIC FERIO**

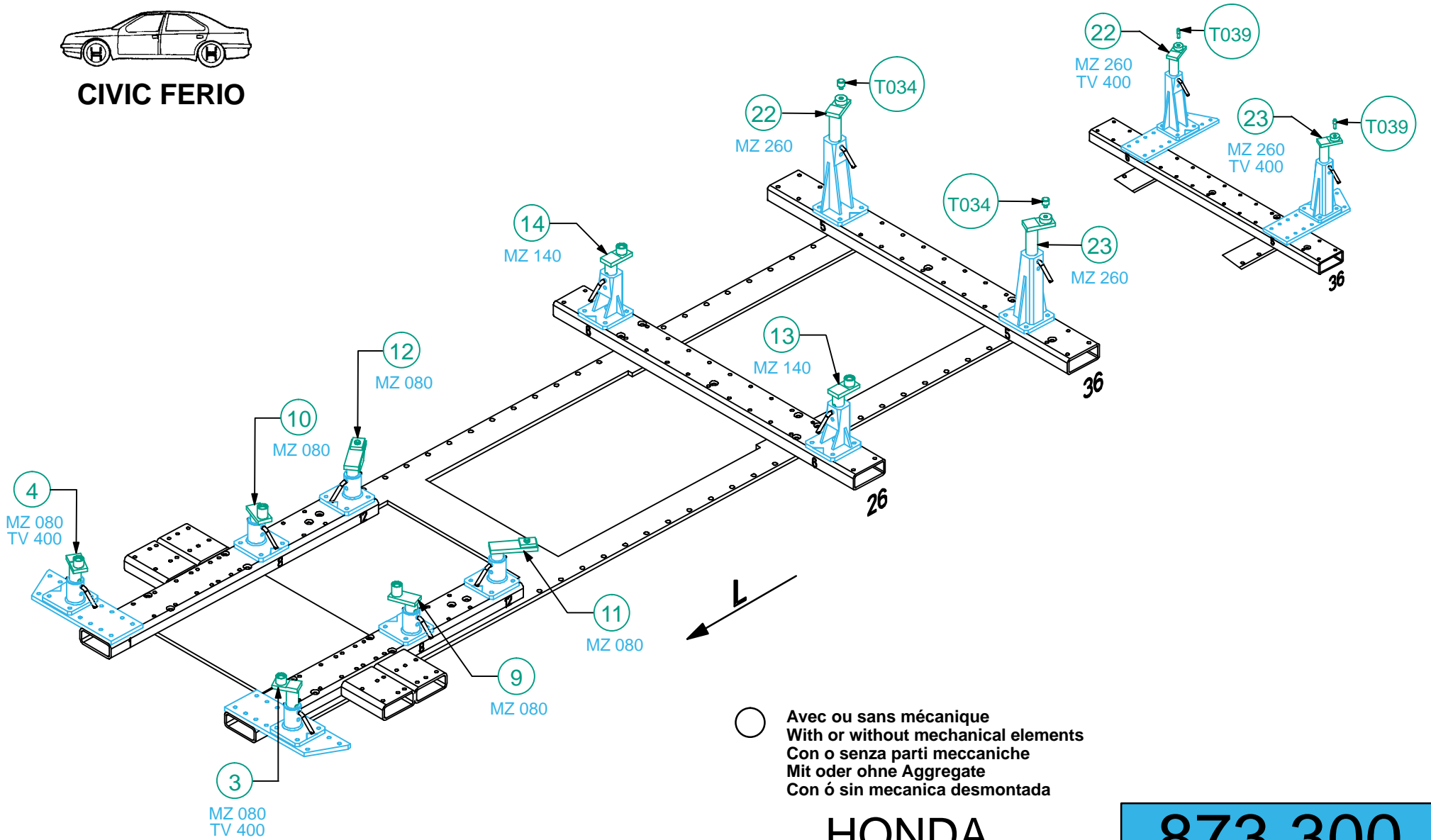

**HONDA**

**873.300**

74 Kg | 31.05.2001 | 413-D-36B

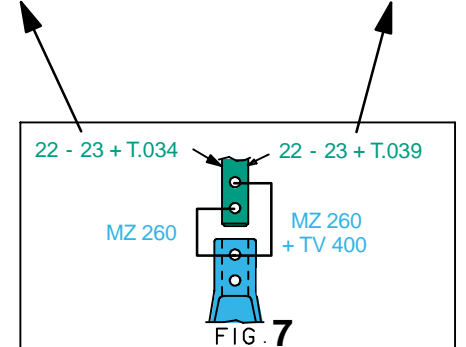
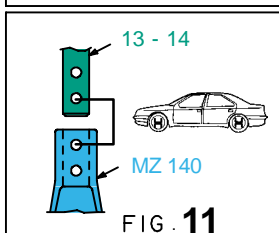
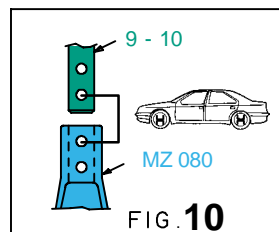
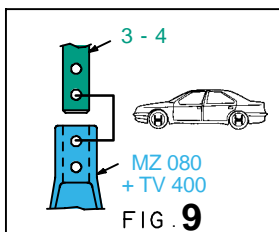
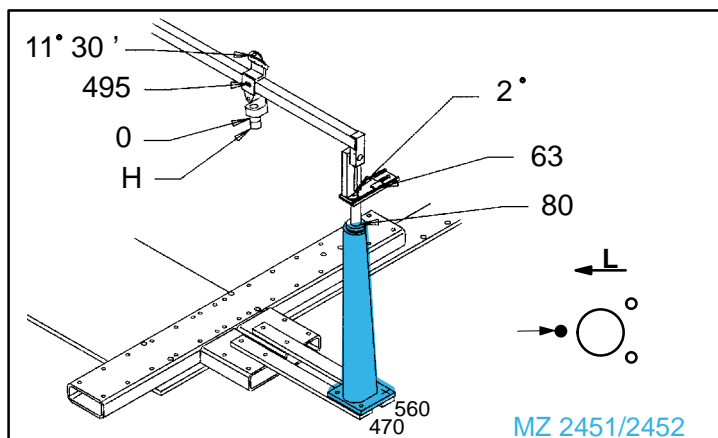
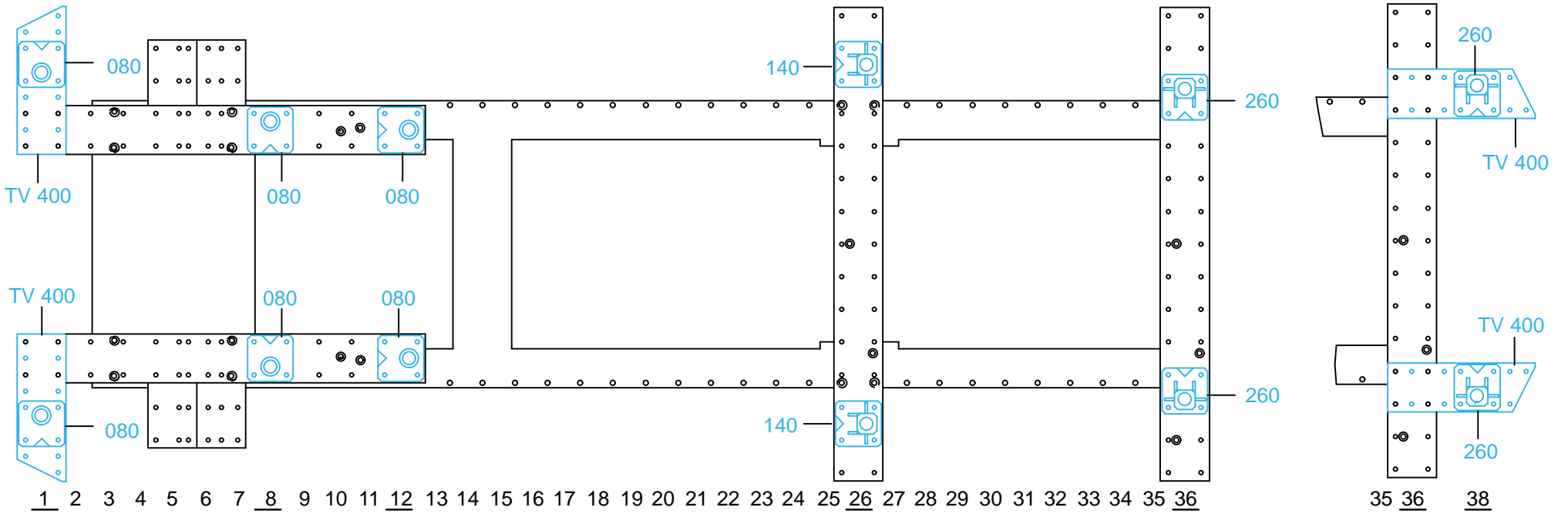



**CIVIC**

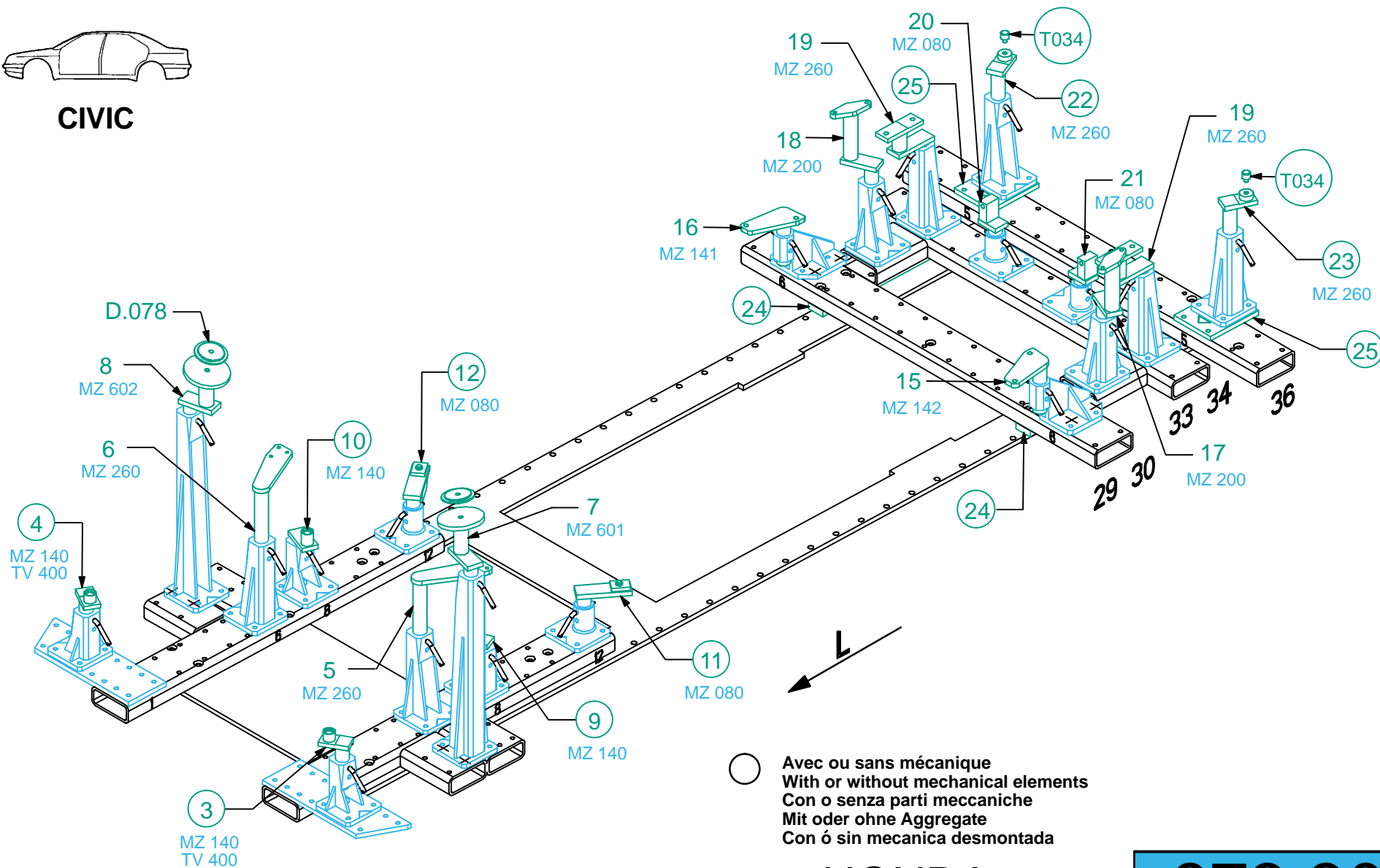

**HONDA**

**873.300**

74 Kg 31.05.2001 413-D-36C

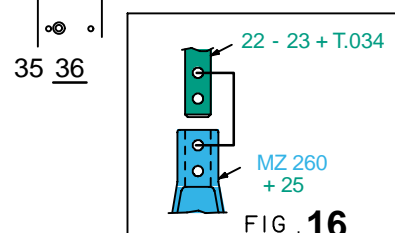
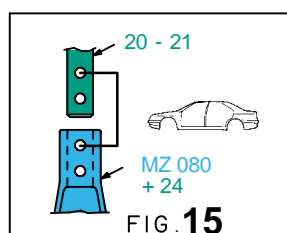
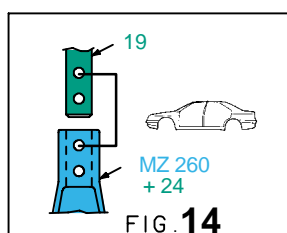
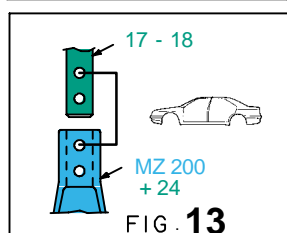
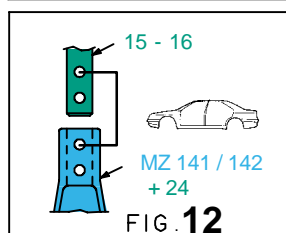
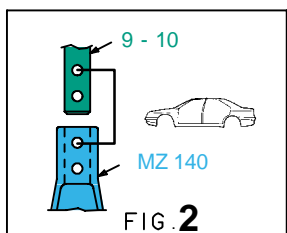
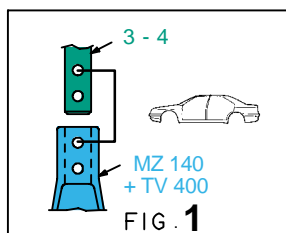
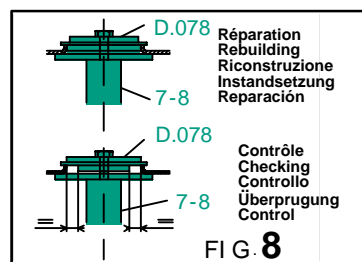
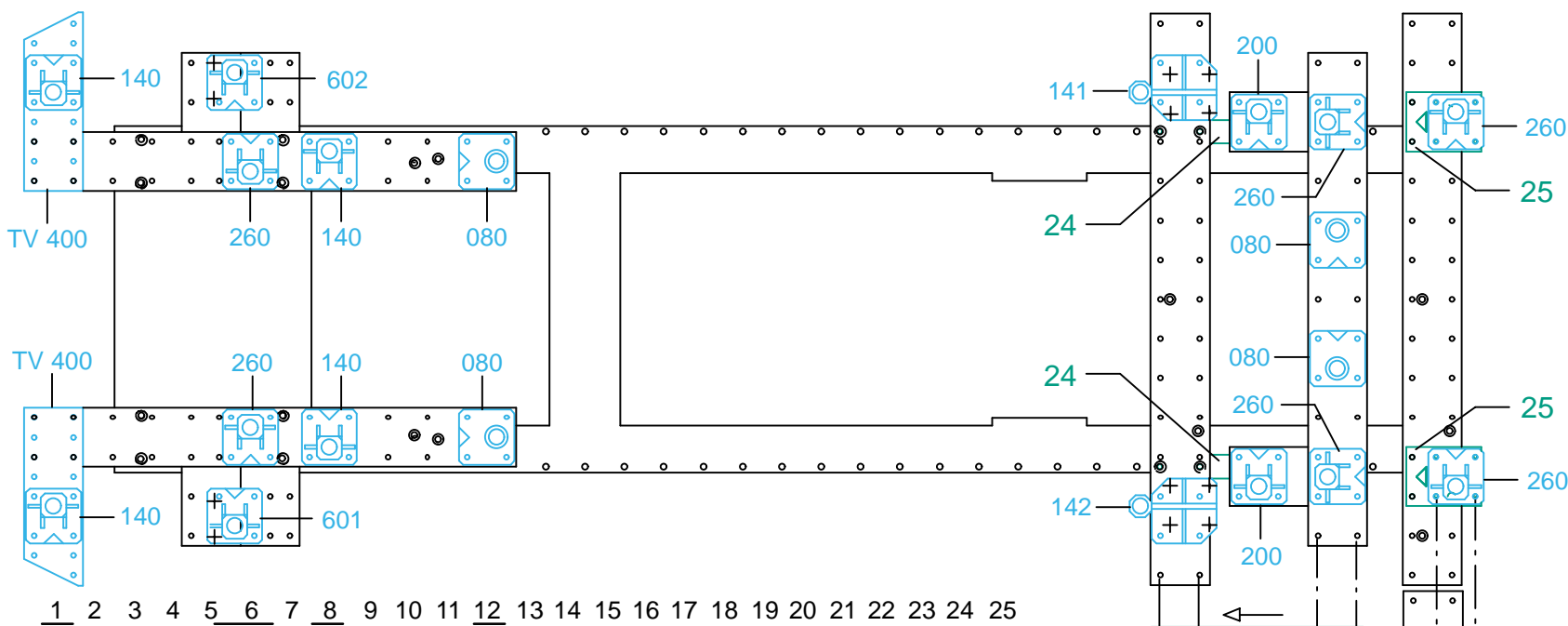



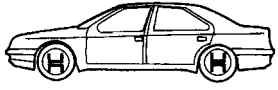

**CIVIC**

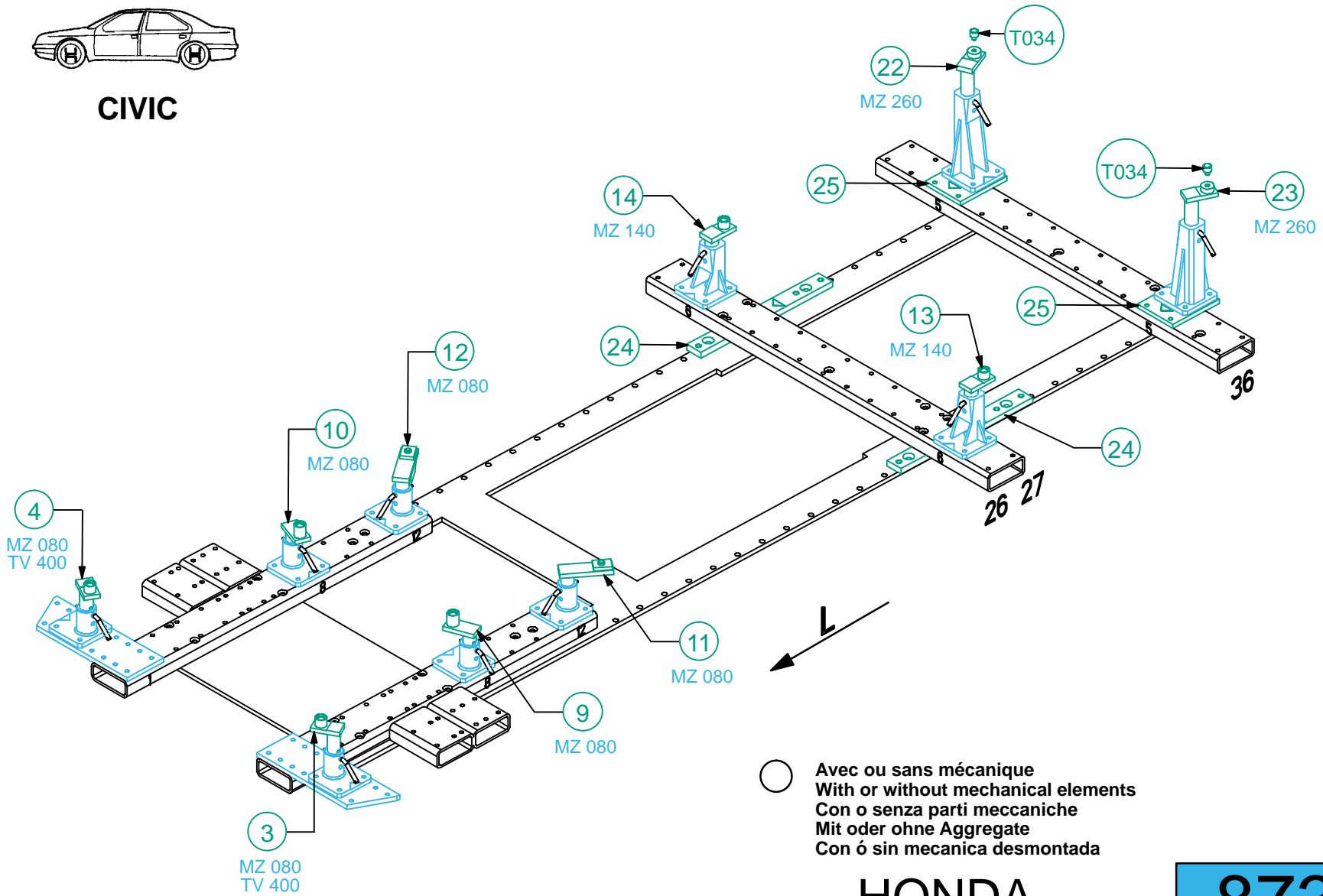

**HONDA**

**873.300**

74 Kg    31.05.2001    413-D-36D

