

**PROPULSION
REAR WHEEL DRIVE
HINTERRADANTRIEB
PROPULSIONE
PROPULSIÓN**

**M8S
MT10
SVN**

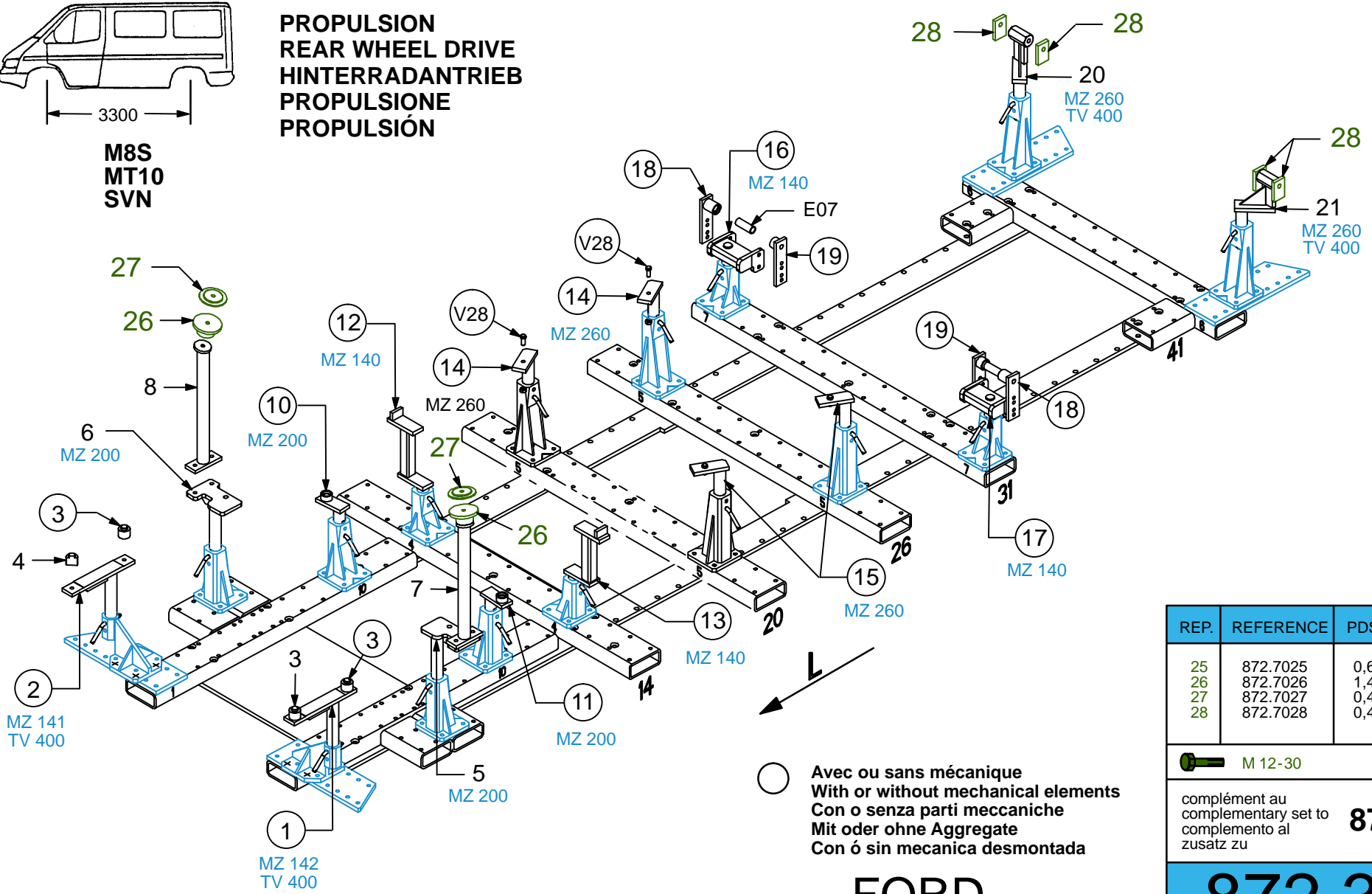

REP.	REFERENCE	PDS	NB	MZ
25	872.7025	0,6	1	
26	872.7026	1,4	2	
27	872.7027	0,4	2	
28	872.7028	0,4	4	

M 12-30 2
complément au
complementary set to
complemento al
zusatz zu **872.300**

872.309
6 Kg 08.10.2007 412-D-27A1

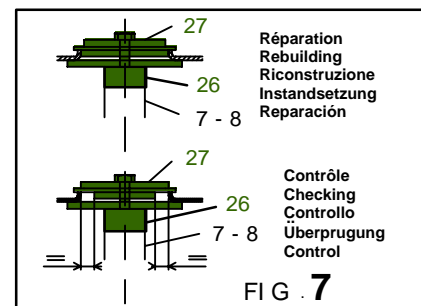
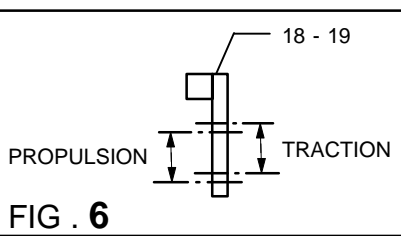
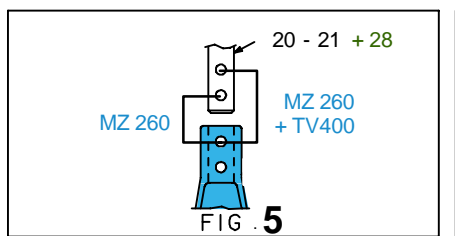
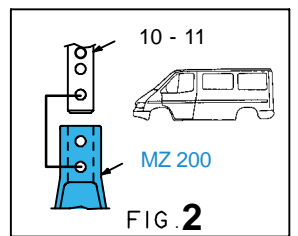
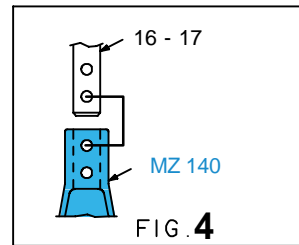
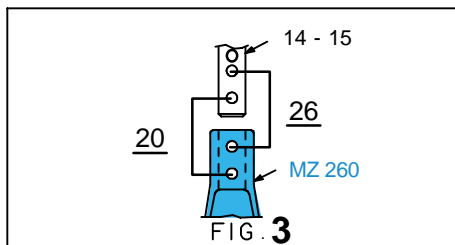
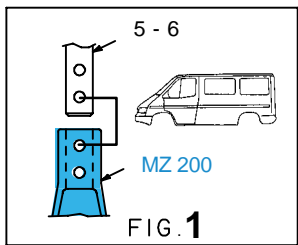
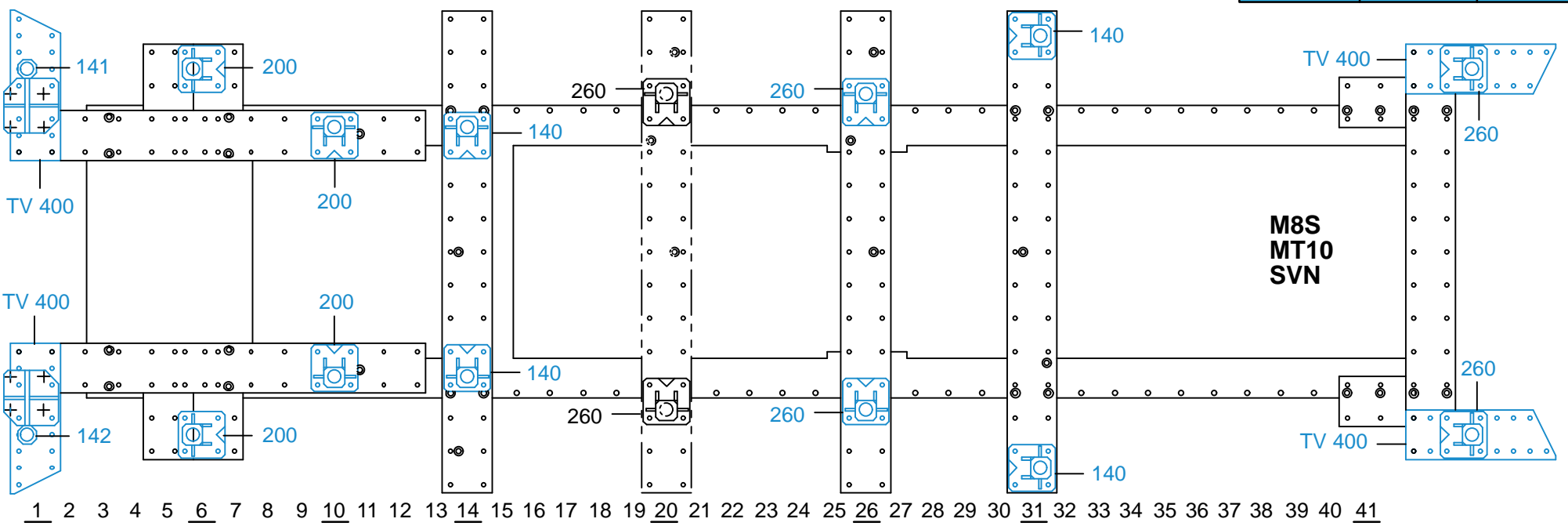

872.309-RVA3-1 00

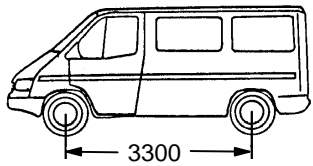

PROPULSION
 REAR WHEEL DRIVE
 HINTERRADANTRIEB
 PROPULSIONE
 PROPULSIÓN

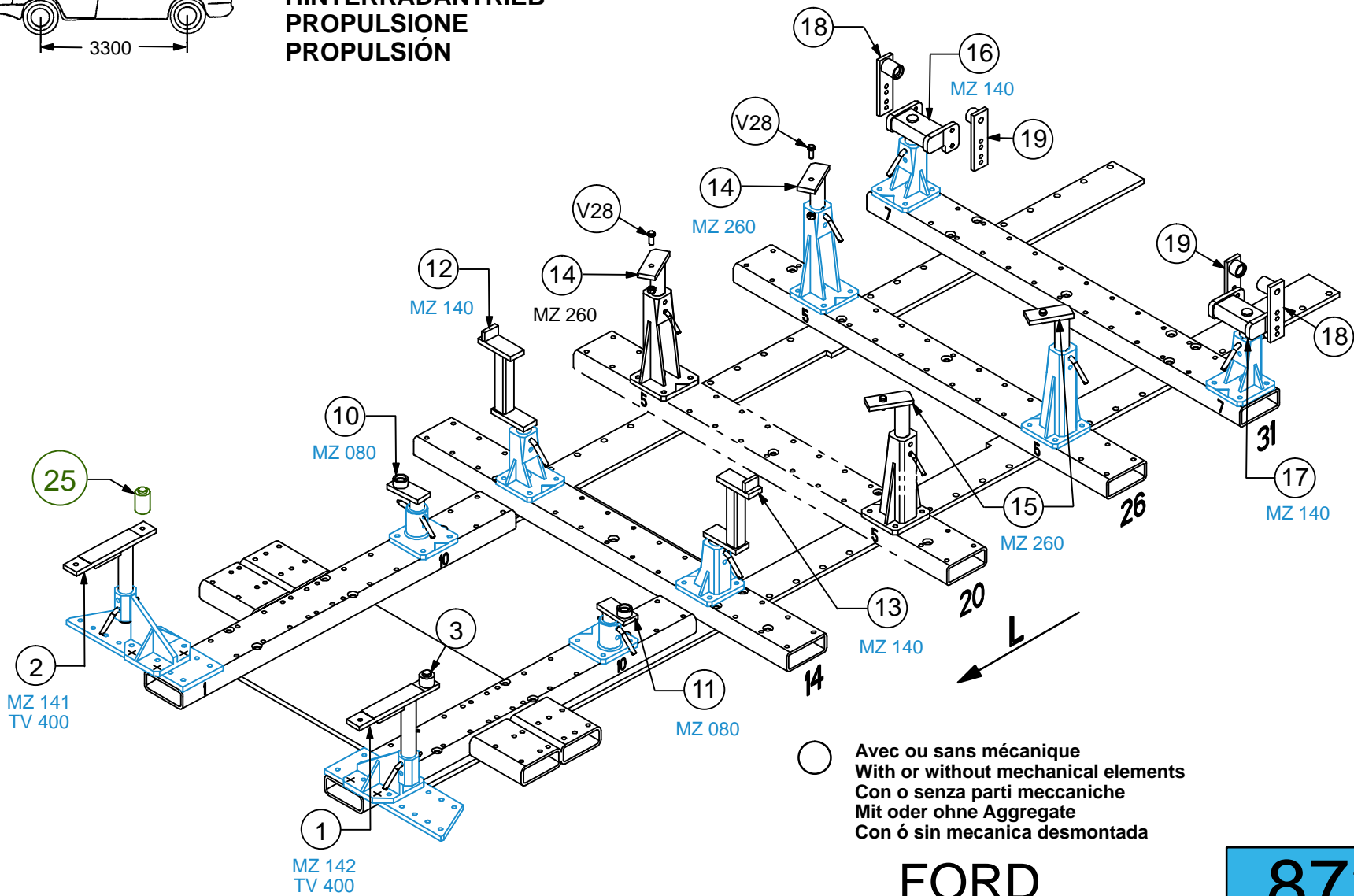

FORD

872.309

6 Kg | 08.10.2007 | 412-D-27B1

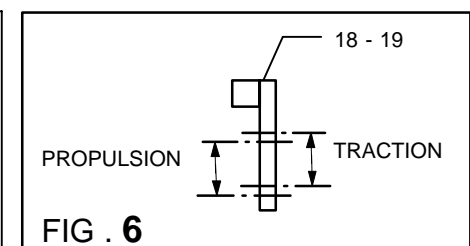
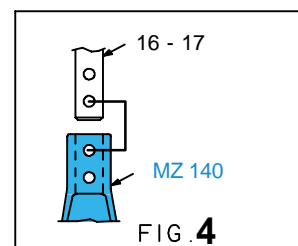
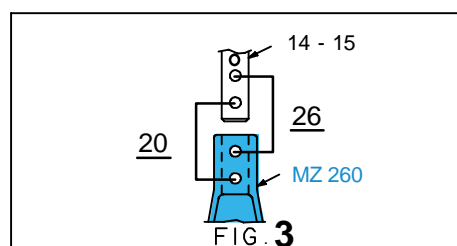
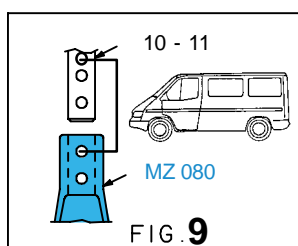
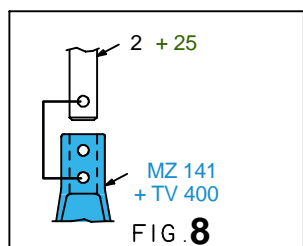
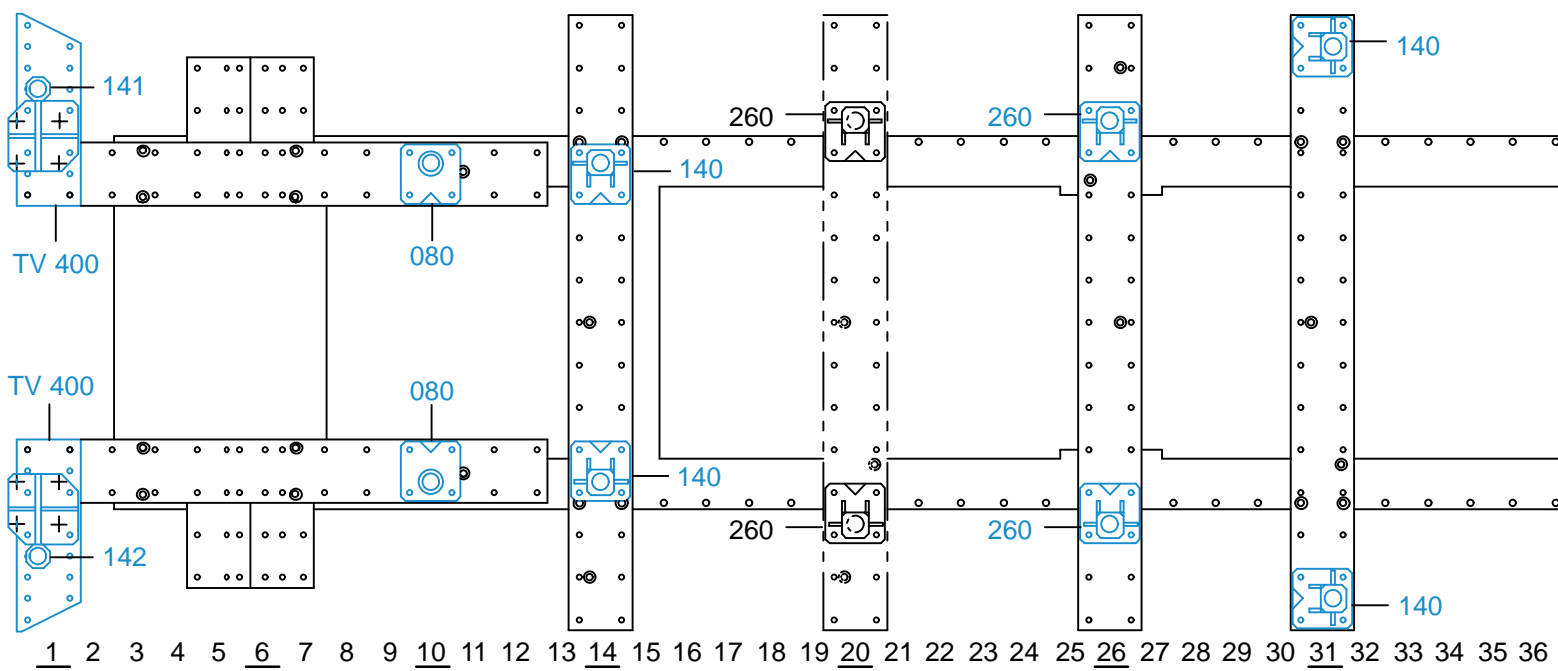

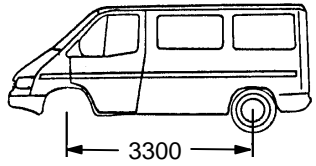

**PROPULSION
REAR WHEEL DRIVE
HINTERRADANTRIEB
PROPULSIONE
PROPULSIÓN**

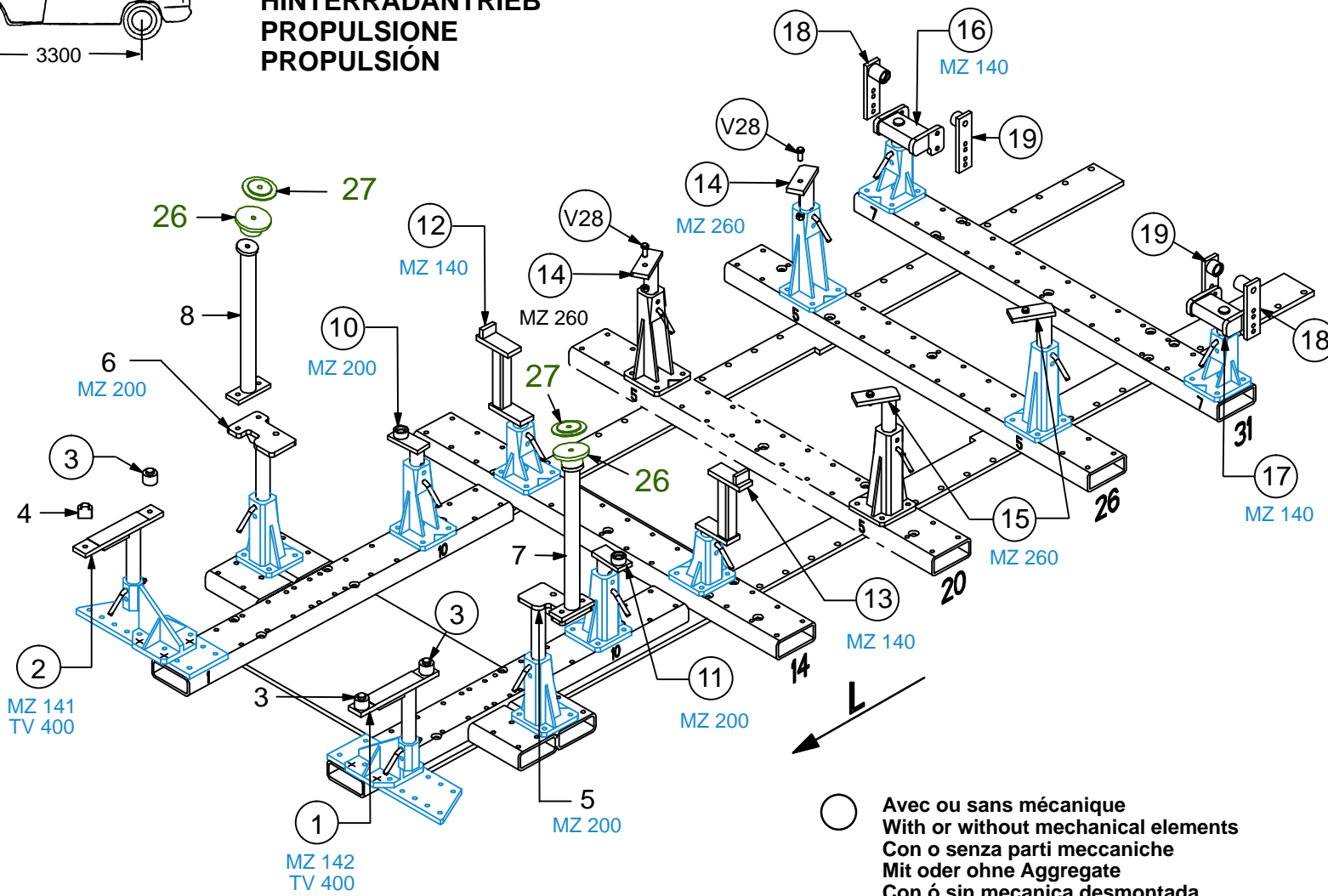

FORD

872.309

6 Kg | 08.10.2005 | 412-D-27C1

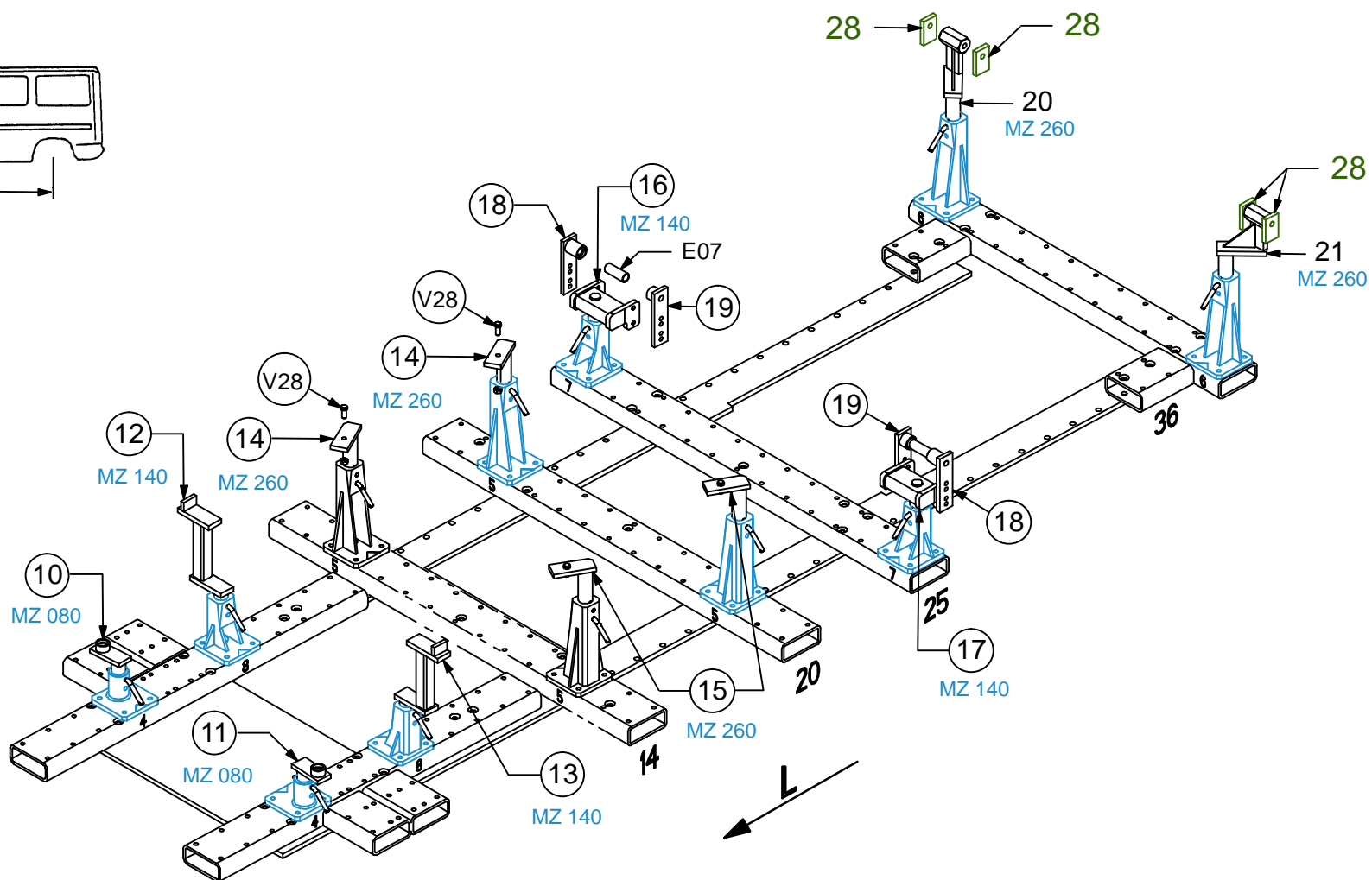
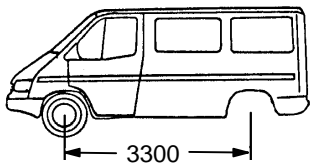

872.309-RVA3-2 | 00

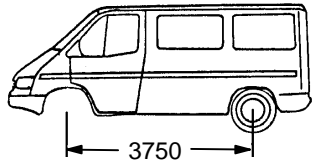

**PROPULSION
REAR WHEEL DRIVE
HINTERRADANTRIEB
PROPULSIONE
PROPULSIÓN**

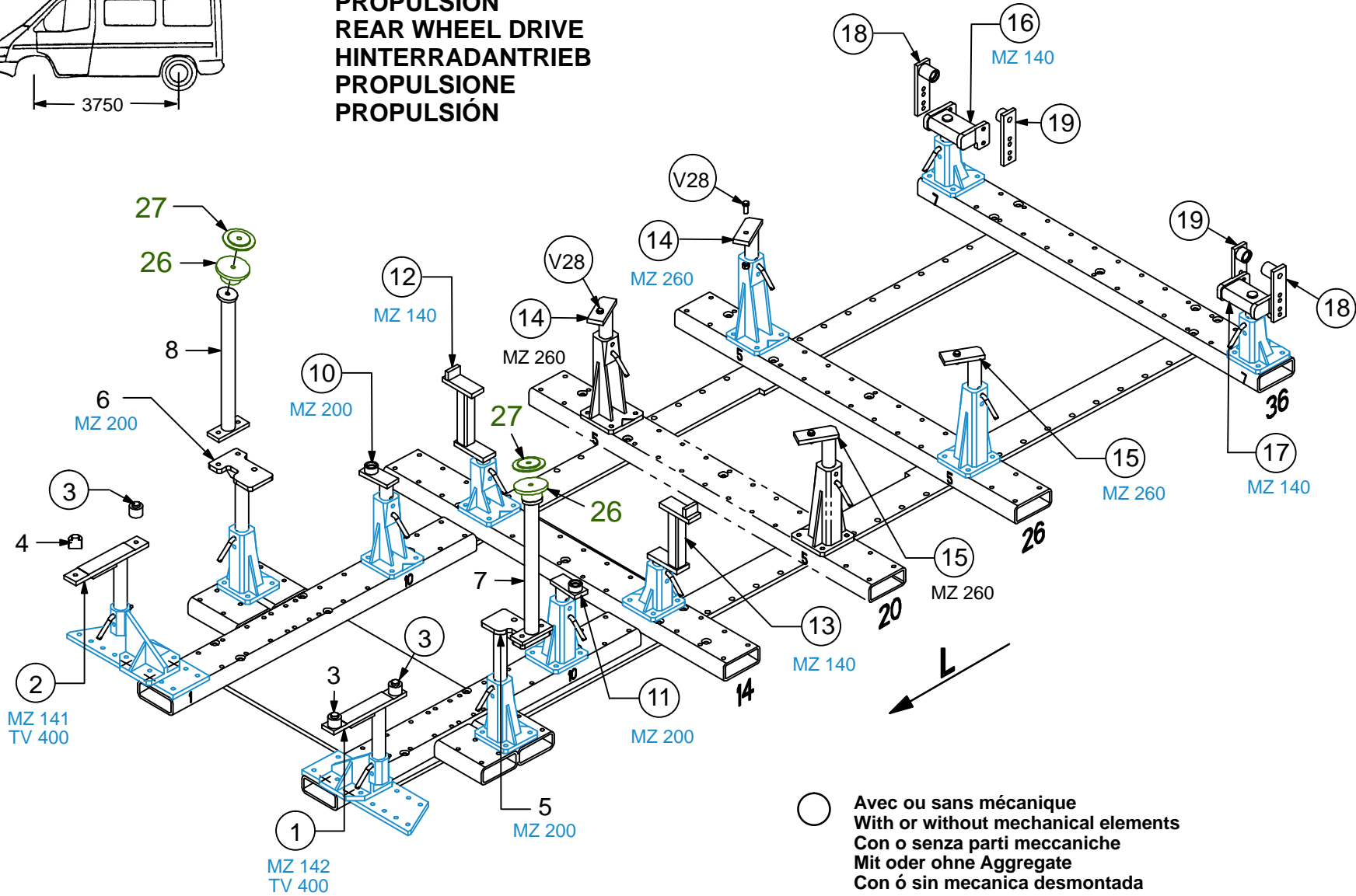

FORD

872.309

6 Kg | 08.10.2007 | 412-D-27D1

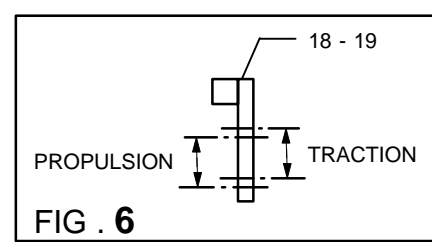
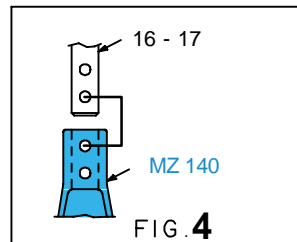
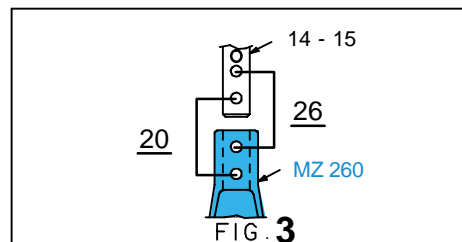
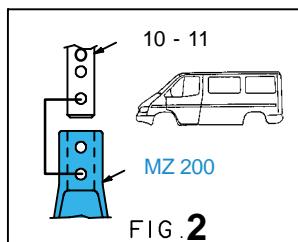
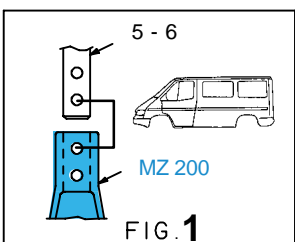
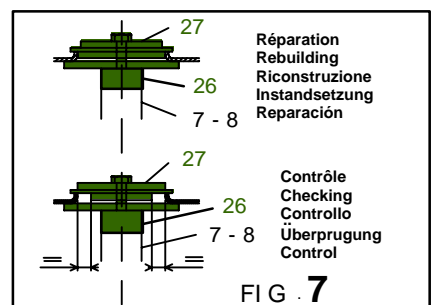
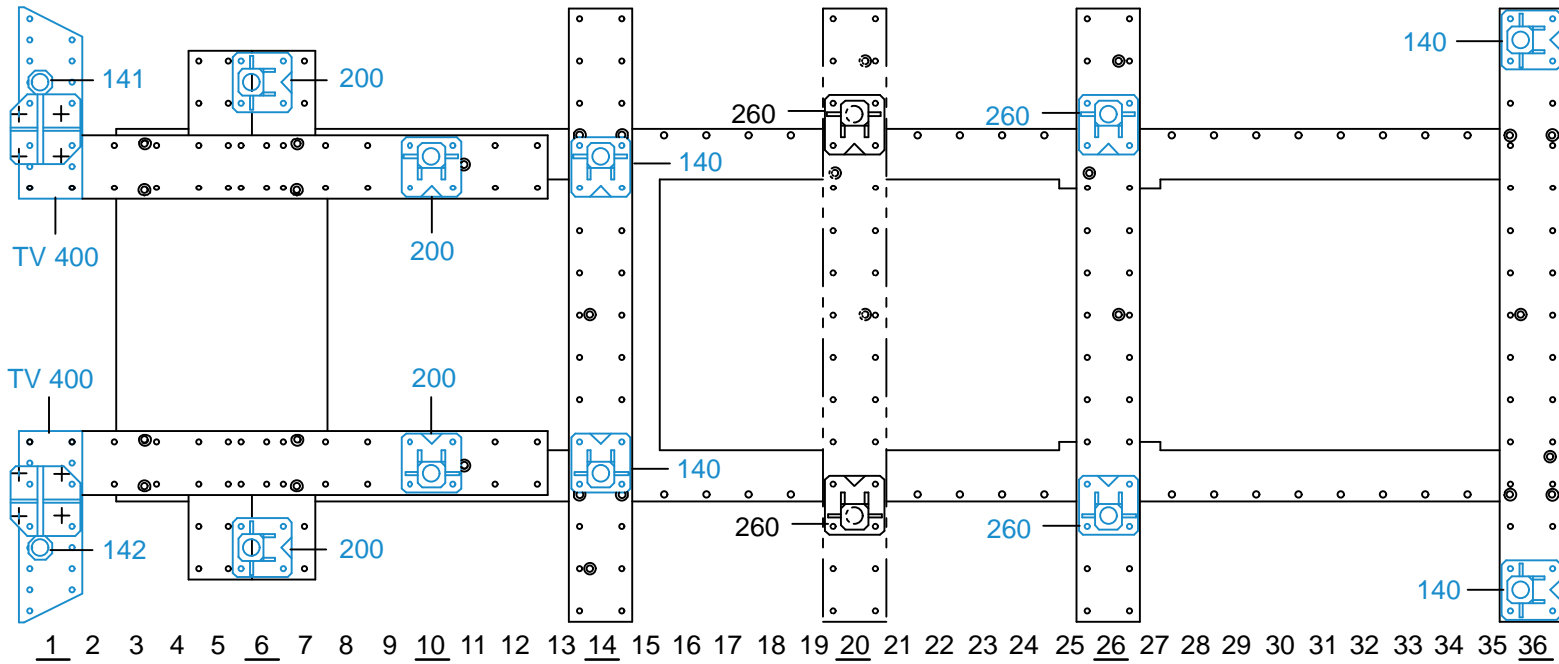

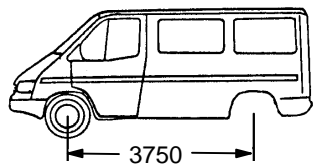

**PROPULSION
REAR WHEEL DRIVE
HINTERRADANTRIEB
PROPULSIONE
PROPULSIÓN**

**M8S
MT10
SVN**

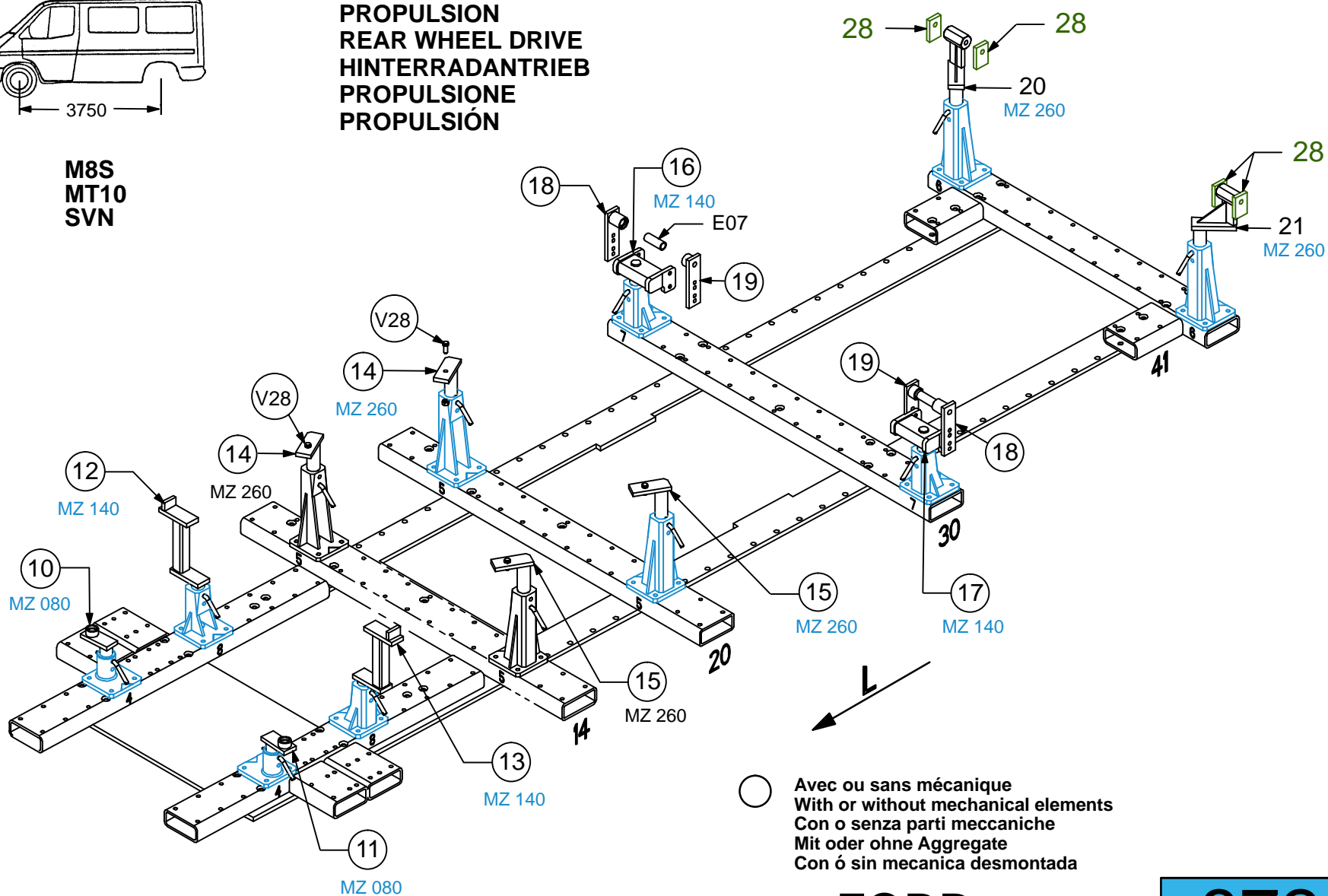

FORD

872.309

6 Kg 08.10.2007 412-D-27E1

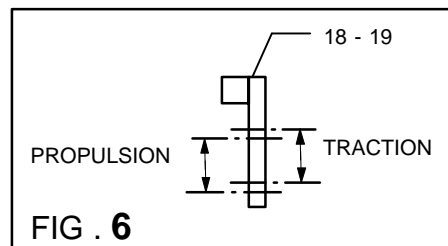
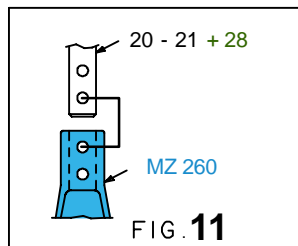
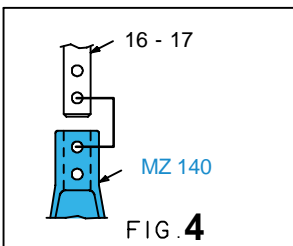
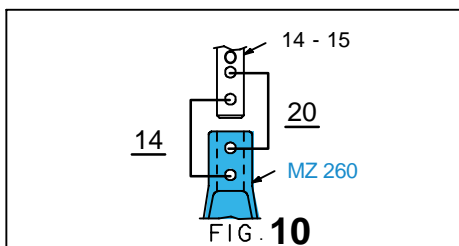
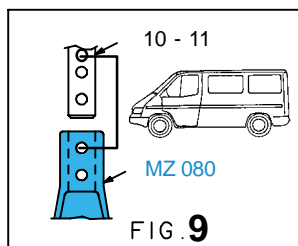
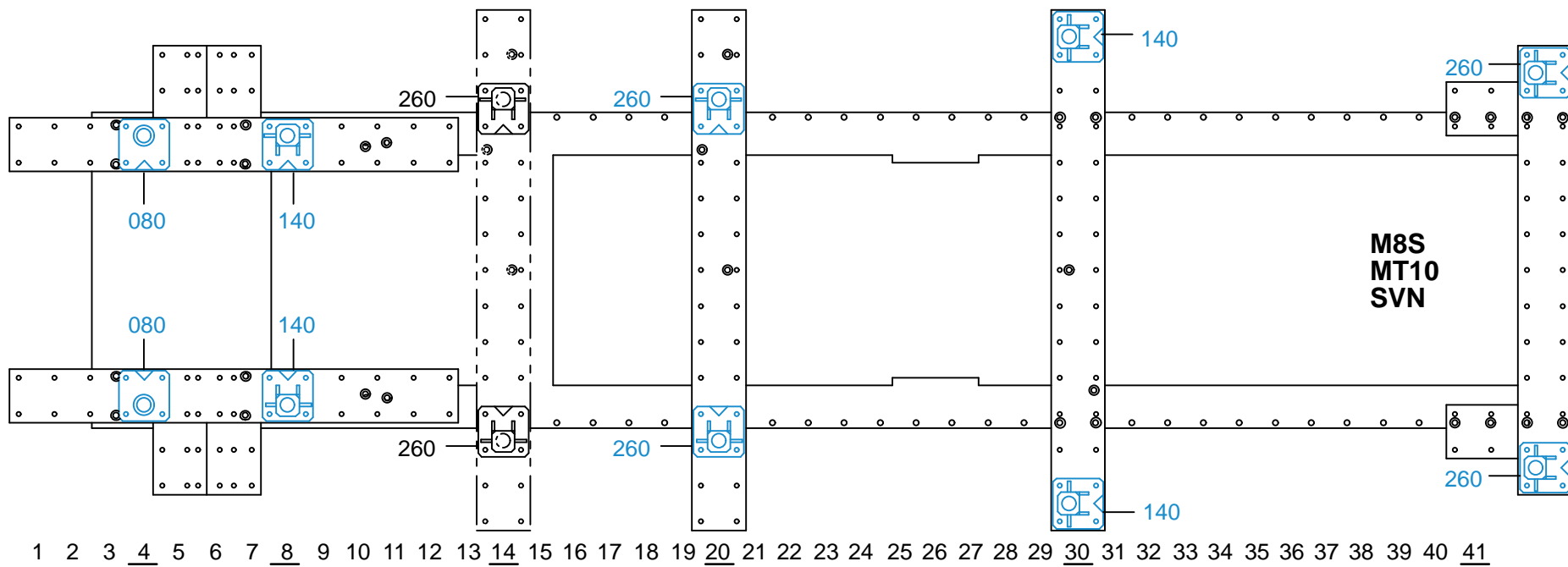

872.309-RVA3-3 00

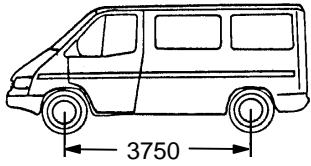

**PROPULSION
REAR WHEEL DRIVE
HINTERRADANTRIEB
PROPULSIONE
PROPULSIÓN**

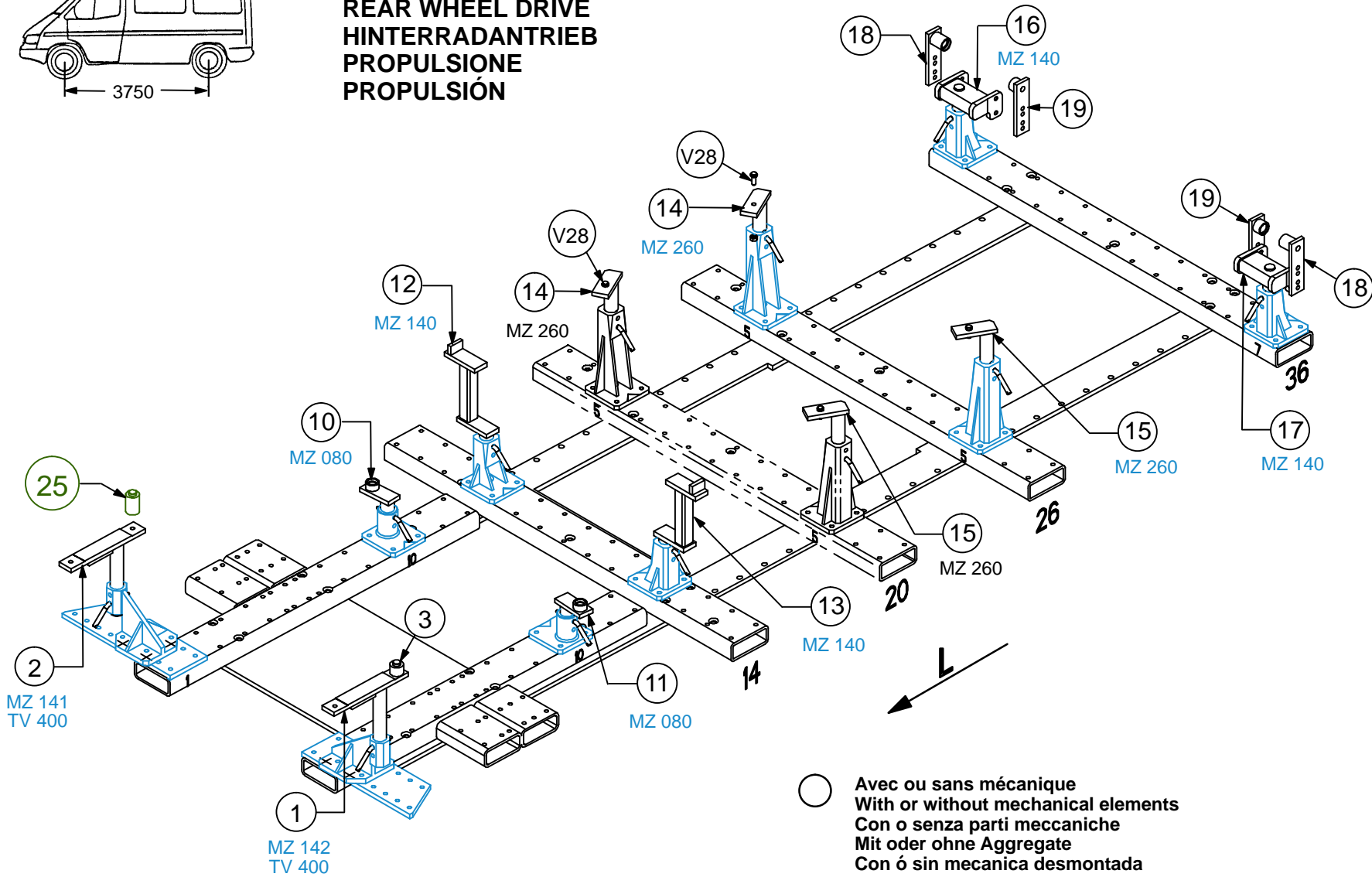

FORD

872.309

6 Kg | 08.10.2007 | 412-D-27F1

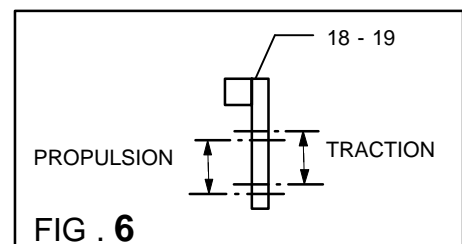
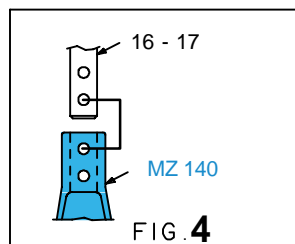
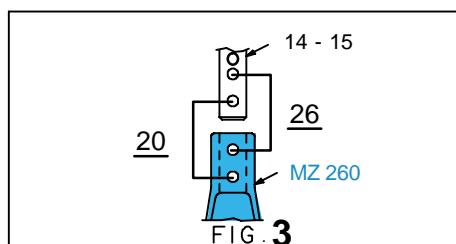
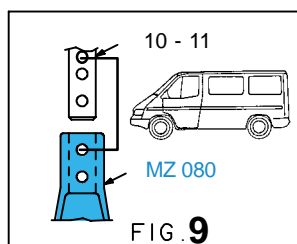
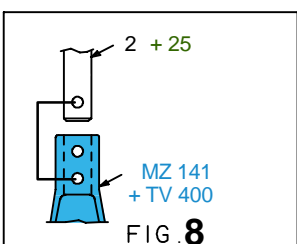
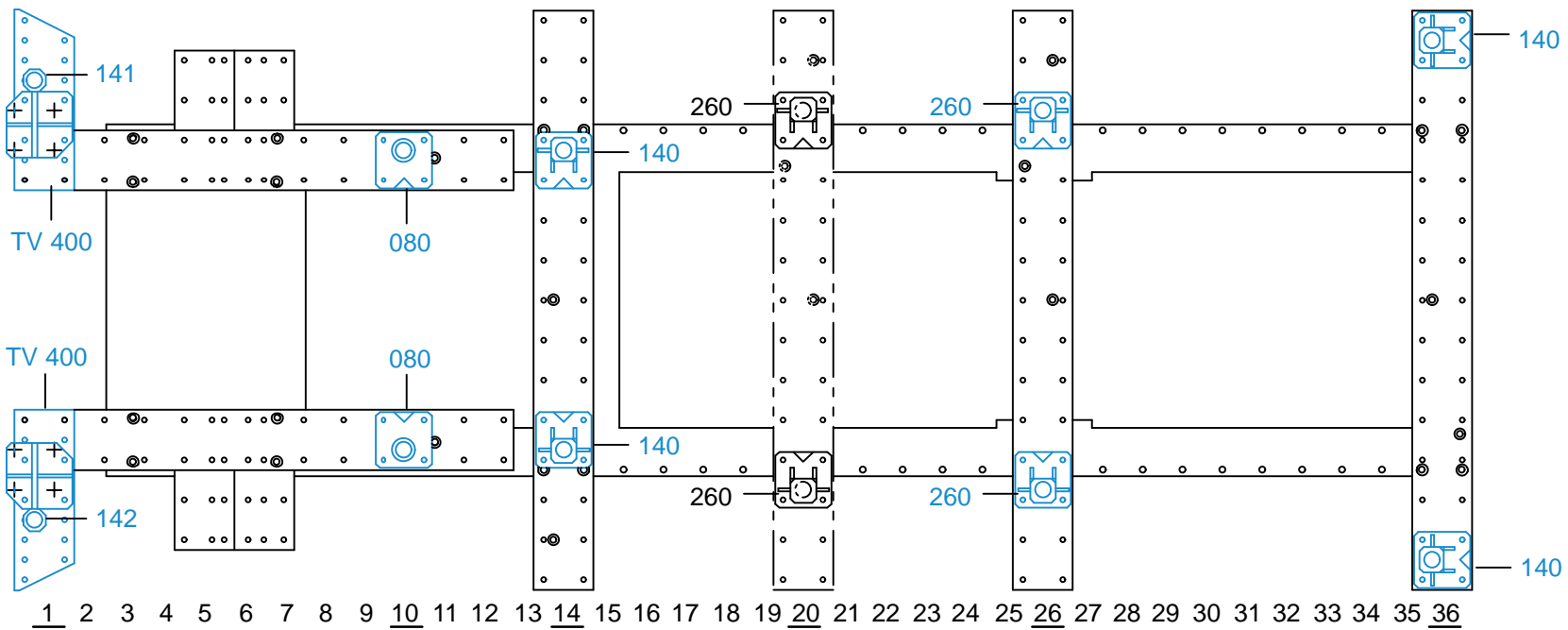

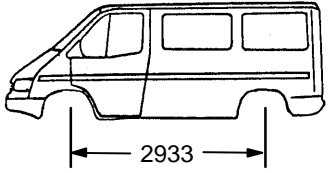

**TRACTION
FRONT WHEEL DRIVE
FRONTANTRIEB
TRAZIONE
TRACCIÓN**

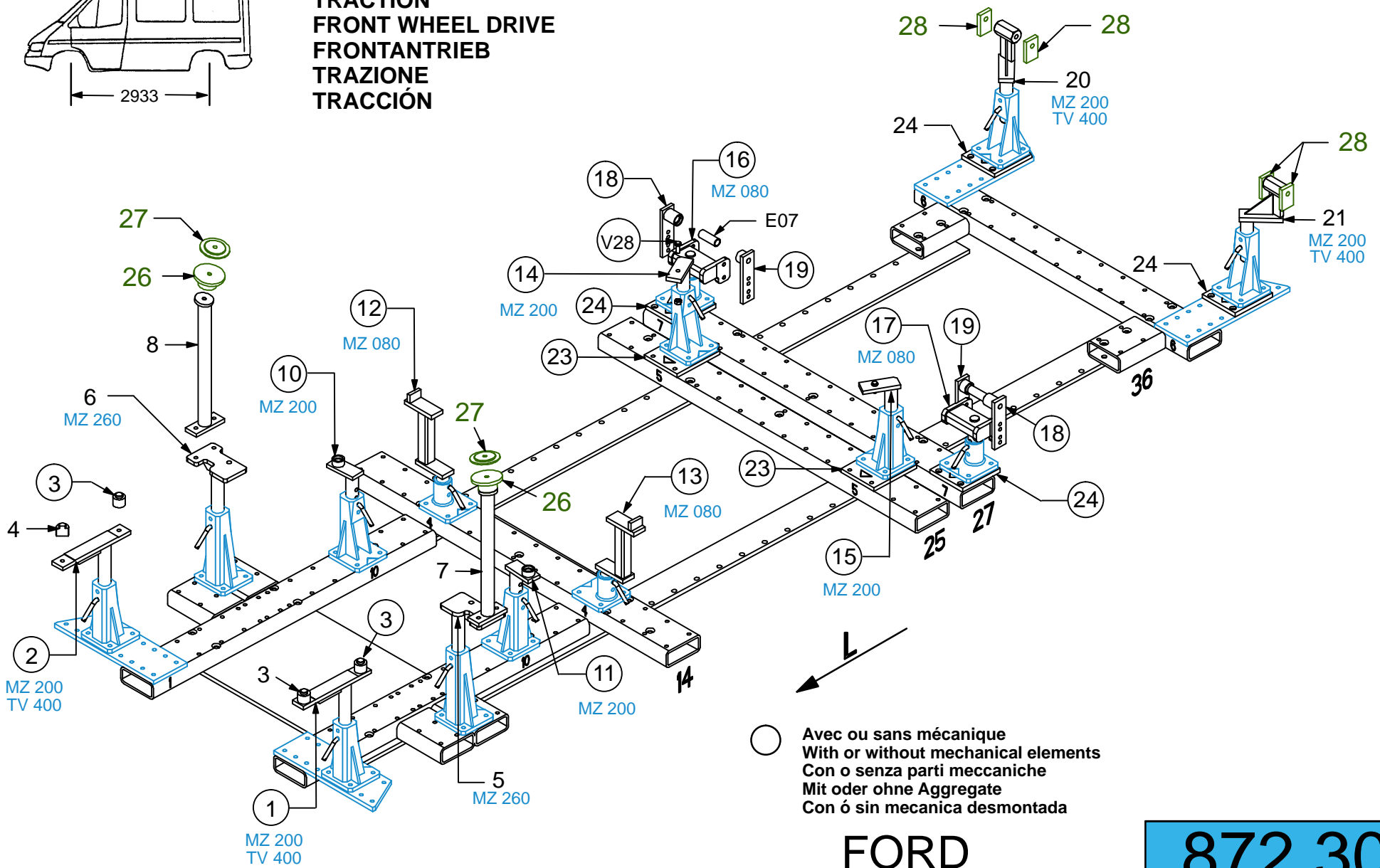

FORD

872.309

6 Kg 08.10.2007 412-D-27G1

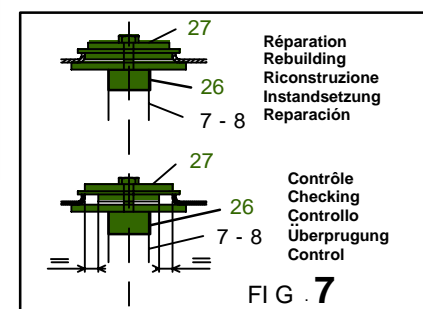
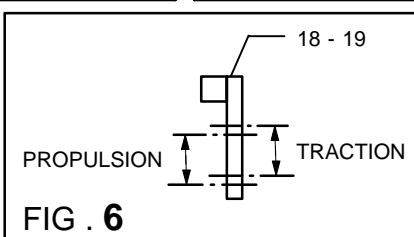
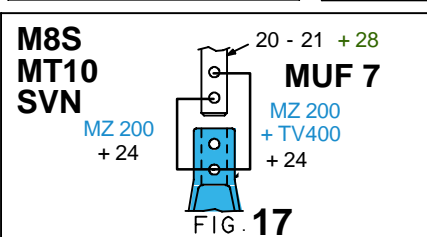
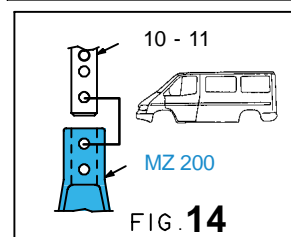
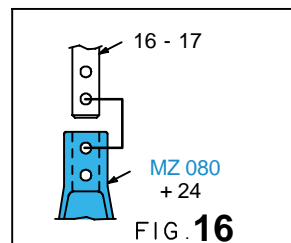
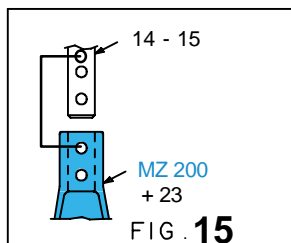
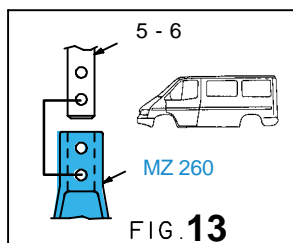
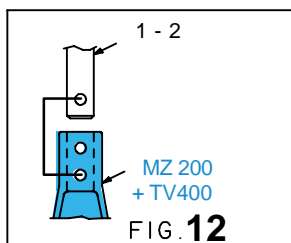
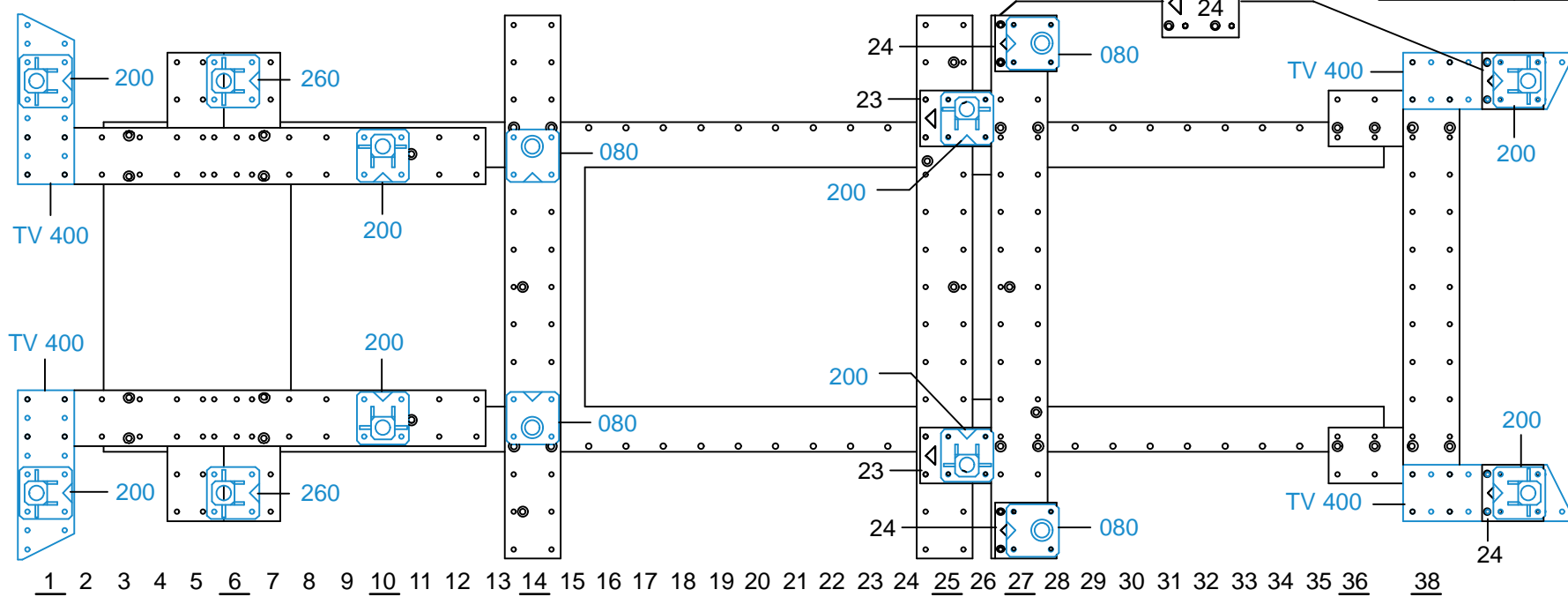

Réparation
Rebuilding
Riconstruzione
Instandsetzung
Reparación

Contrôle
Checking
Controllo
Überprüfung
Control



872.309-RVA3-4 00

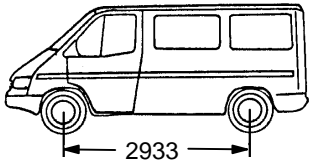

**TRACTION
FRONT WHEEL DRIVE
FRONTANTRIEB
TRAZIONE
TRACCIÓN**

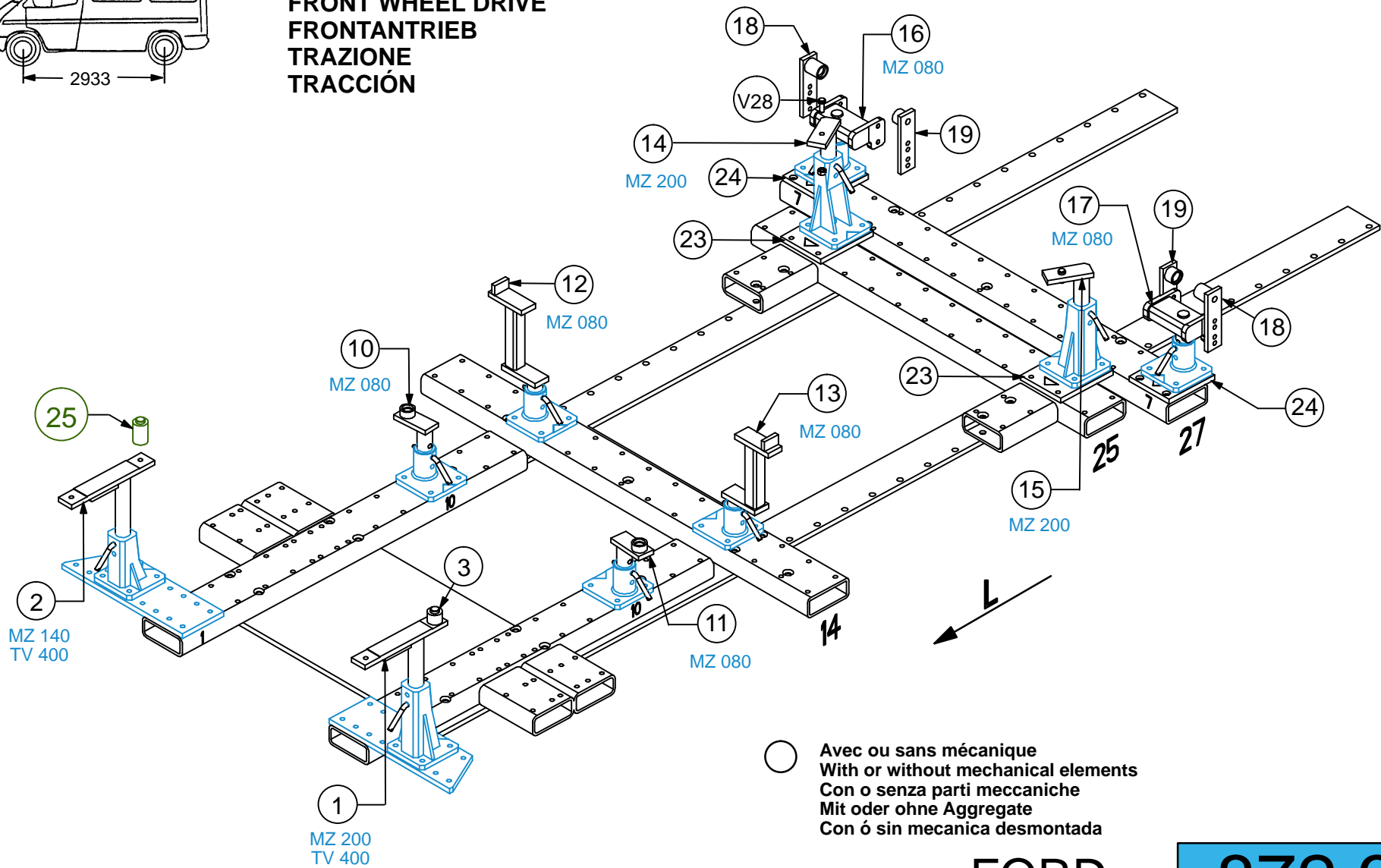

FORD

872.309

6 Kg | 08.10.2007 | 412-D-27H1

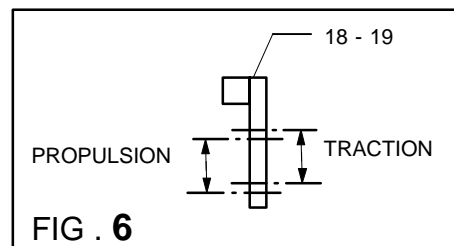
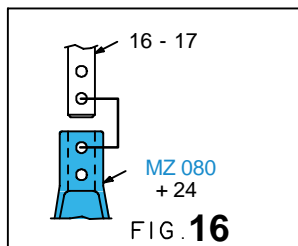
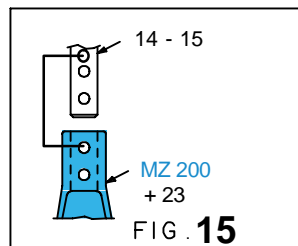
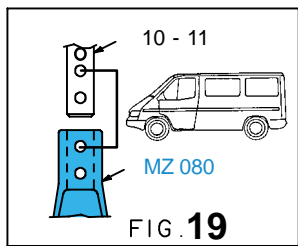
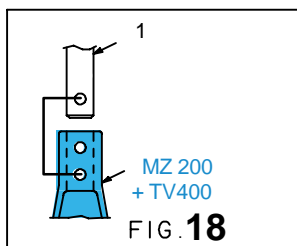
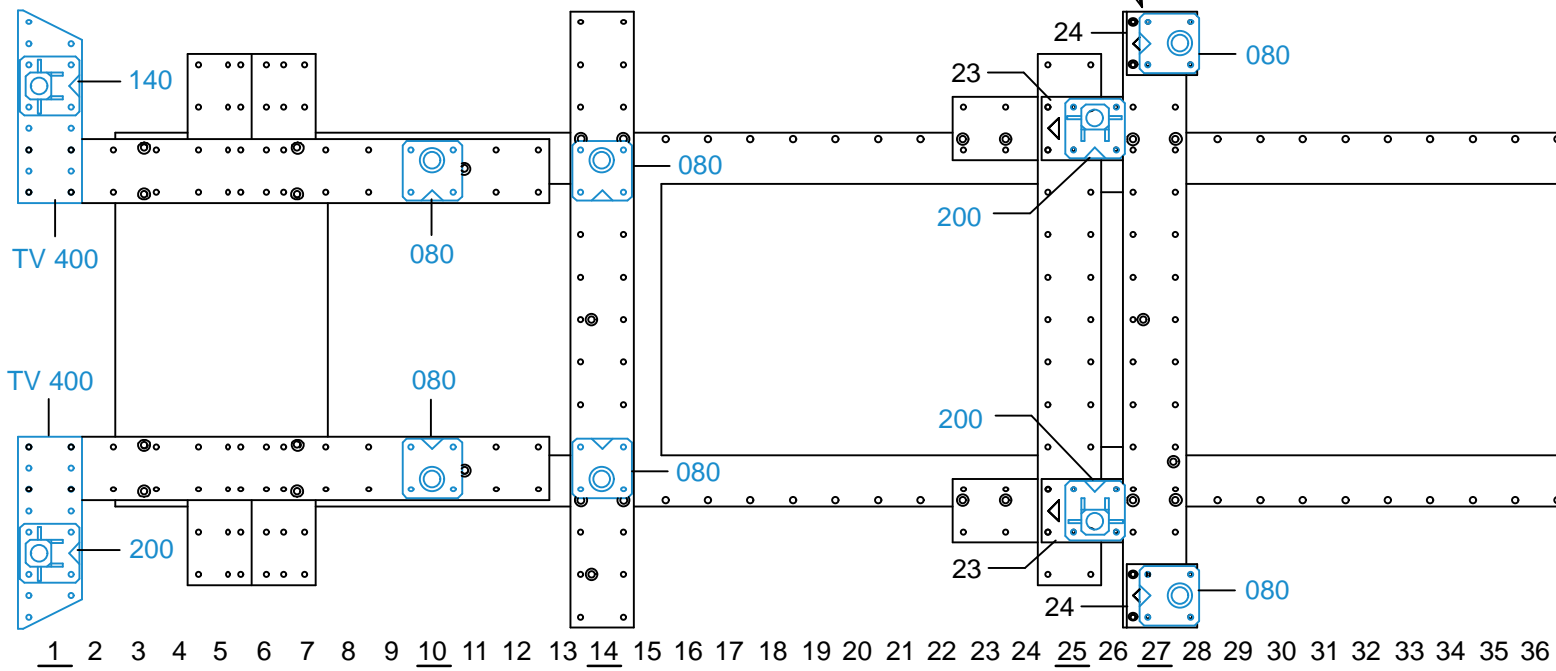

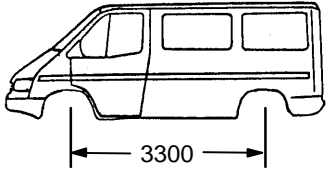

**TRACTION
FRONT WHEEL DRIVE
FRONTANTRIEB
TRAZIONE
TRACCIÓN**

**M8S
MT10
SVN**

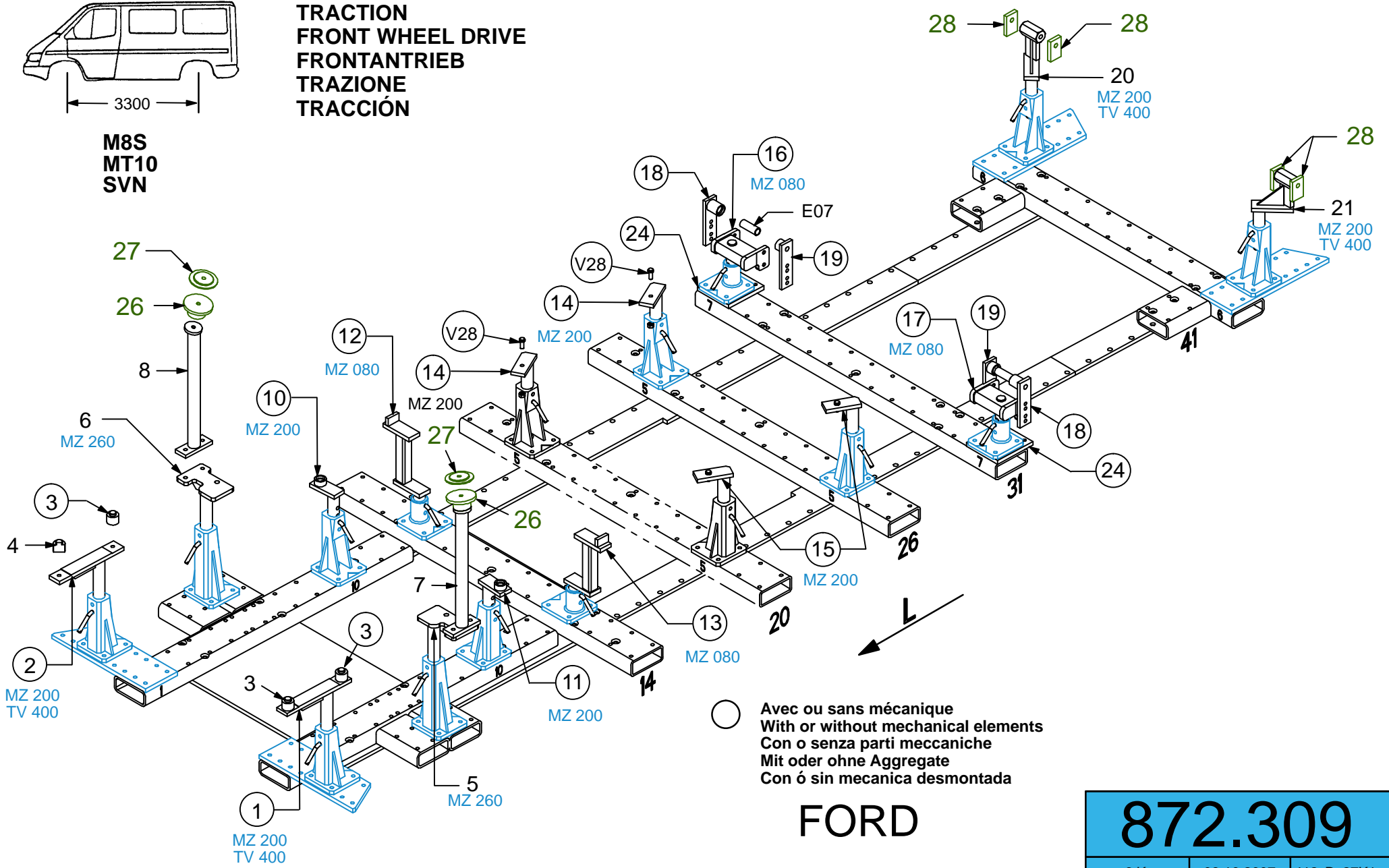

FORD

872.309

6 Kg 08.10.2007 412-D-27K1

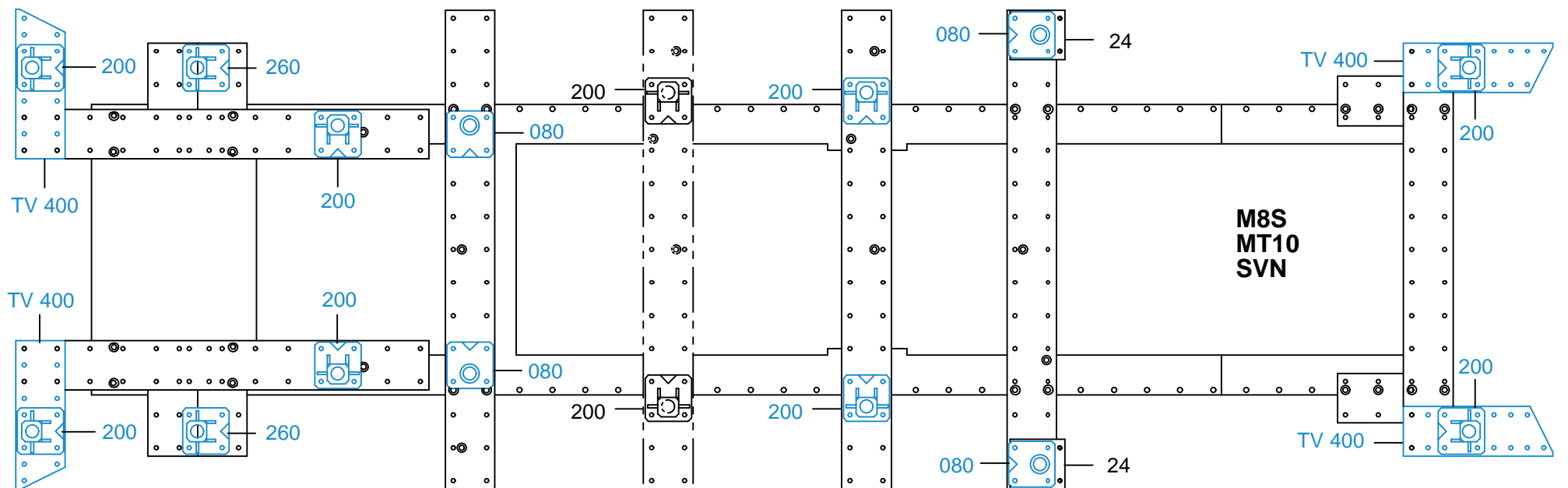

1 2 3 4 5 6 7 8 9 10 11 12 13 14 15 16 17 18 19 20 21 22 23 24 25 26 27 28 29 30 31 32 33 34 35 36 37 38 39 40 41

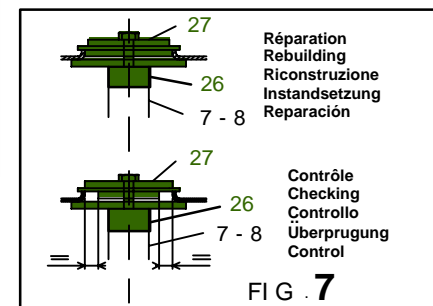
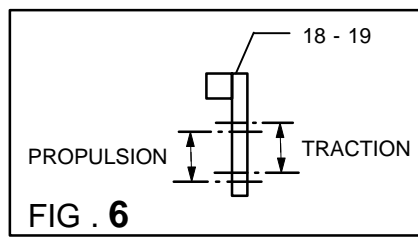
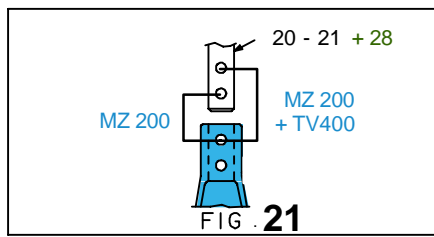
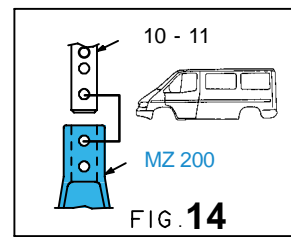
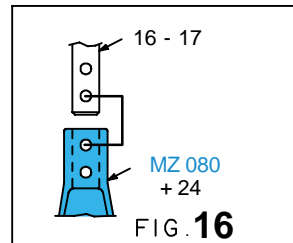
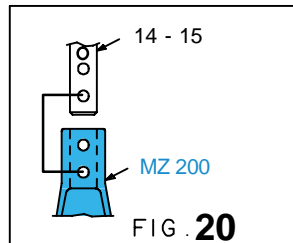
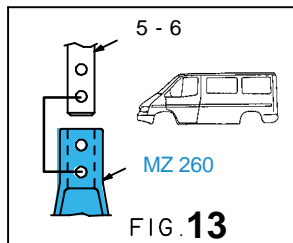
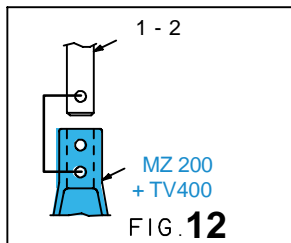

872.309-RVA3-5 00

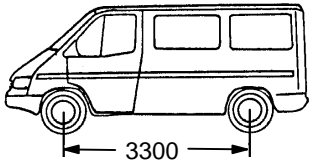

**TRACTION
FRONT WHEEL DRIVE
FRONTANTRIEB
TRAZIONE
TRACCIÓN**

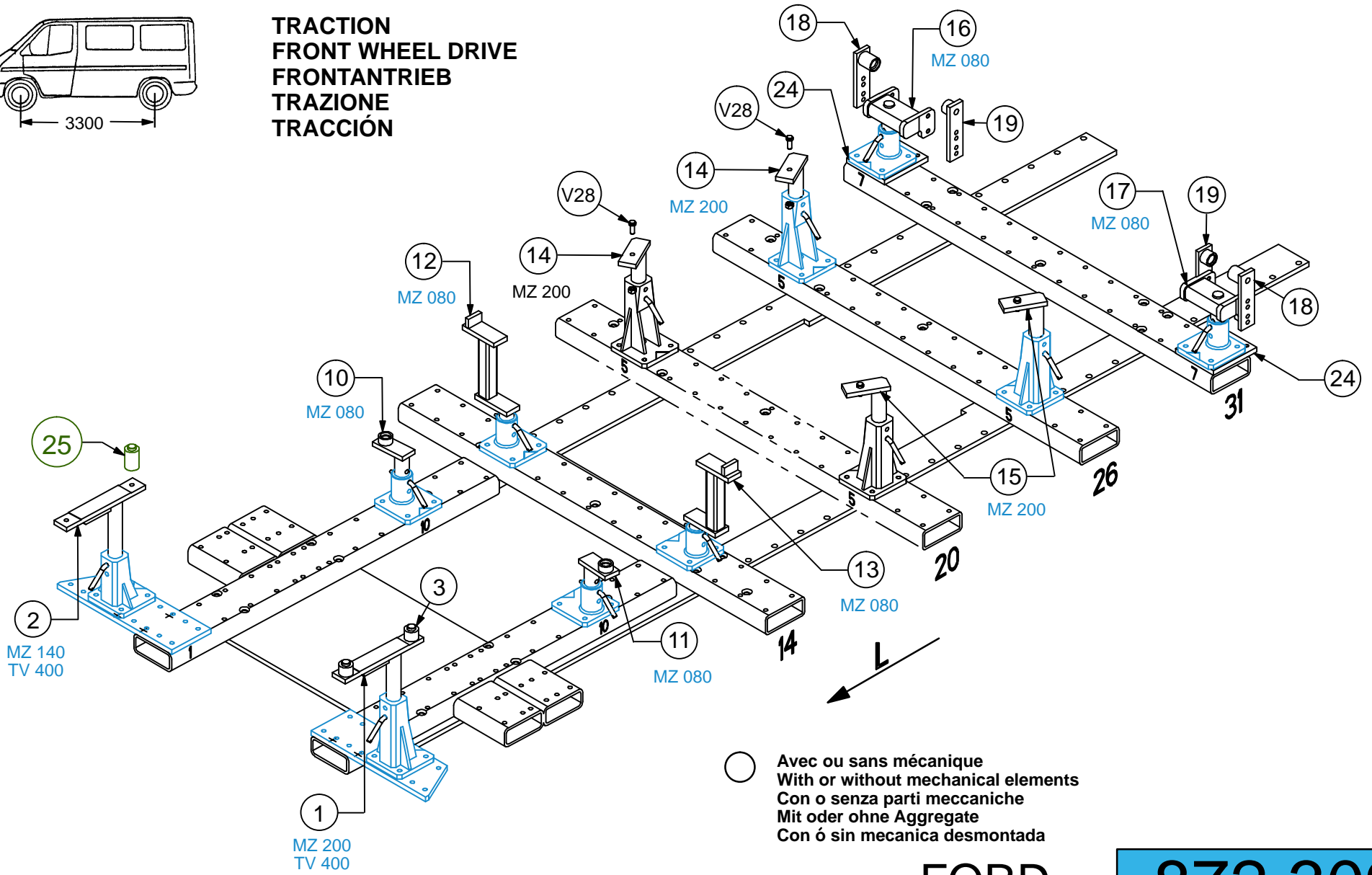

○ Avec ou sans mécanique
With or without mechanical elements
Con o senza parti meccaniche
Mit oder ohne Aggregate
Con ó sin mecanica desmontada

FORD

872.309

6 Kg | 08.10.2007 | 412-D-27L1

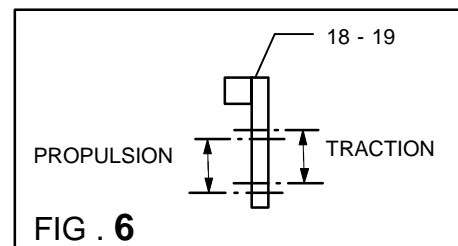
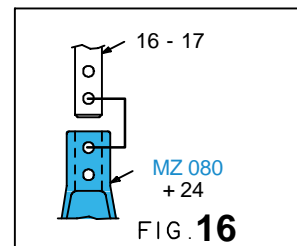
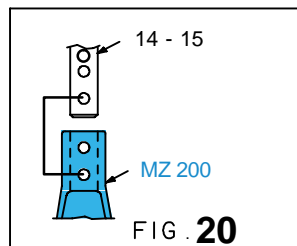
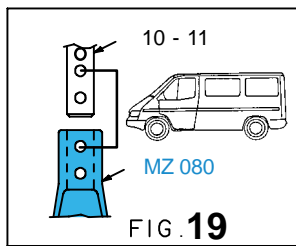
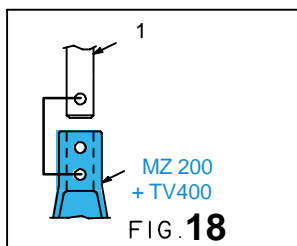
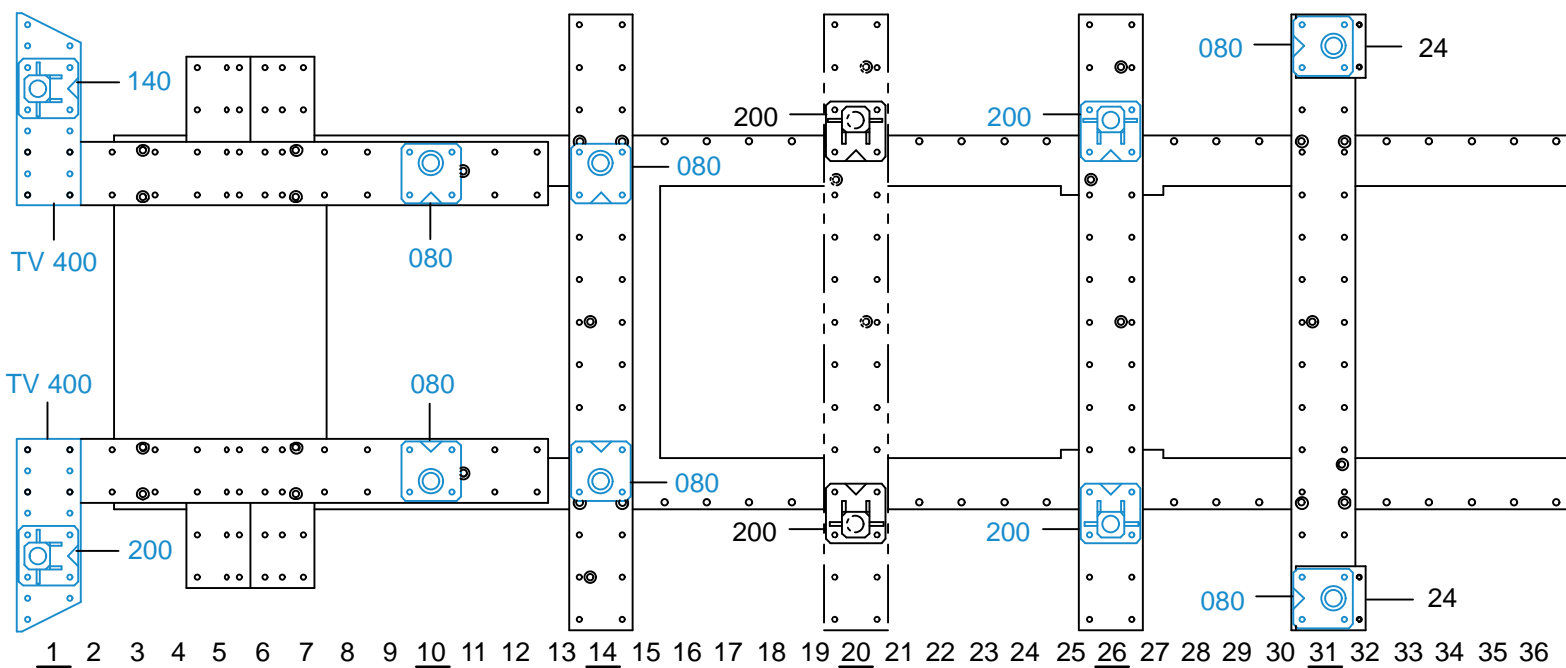

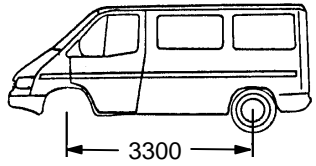

**TRACTION
FRONT WHEEL DRIVE
FRONTANTRIEB
TRAZIONE
TRACCIÓN**

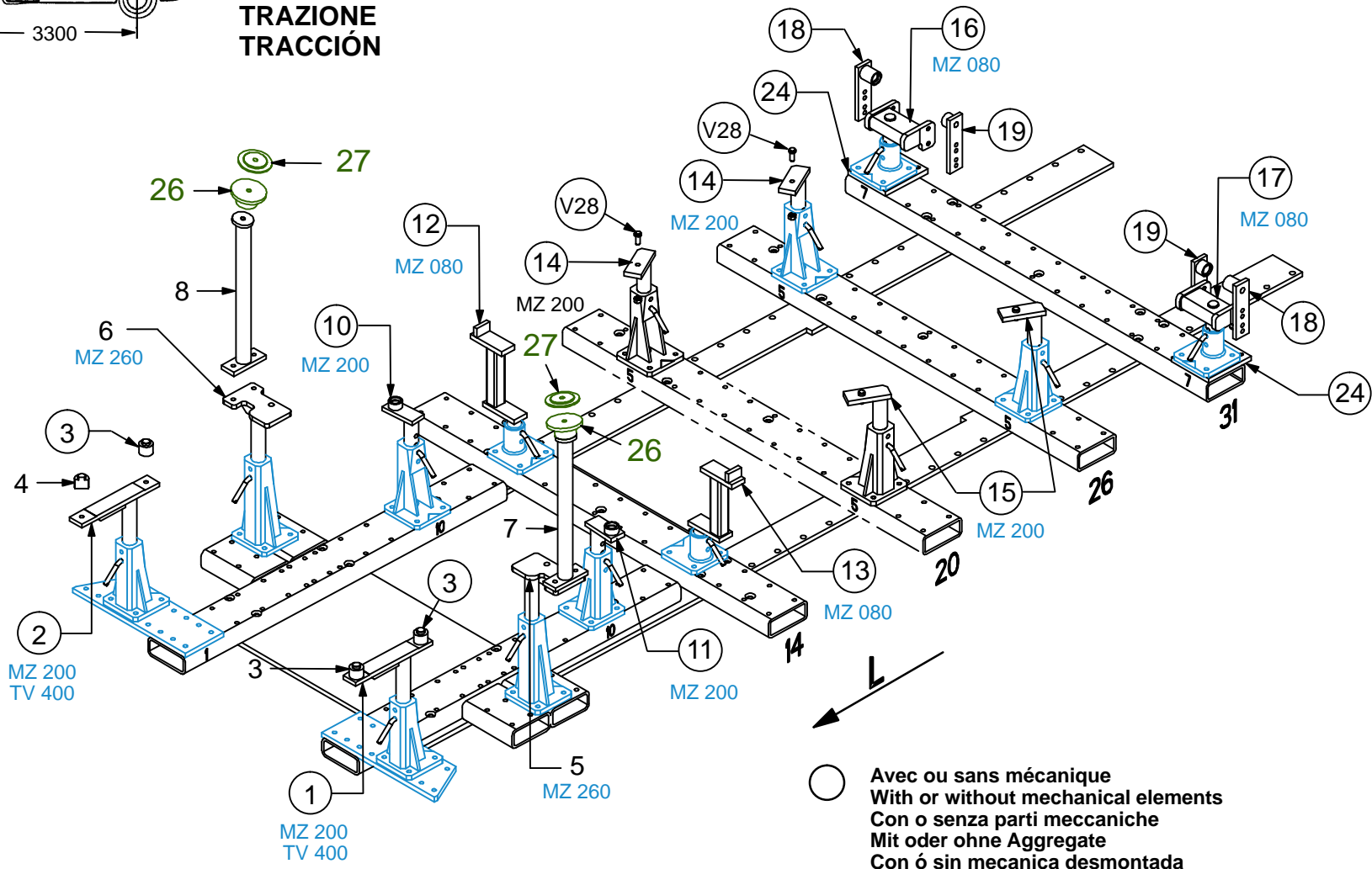

FORD

872.309

6 Kg 08.10.2005 412-D-27M1

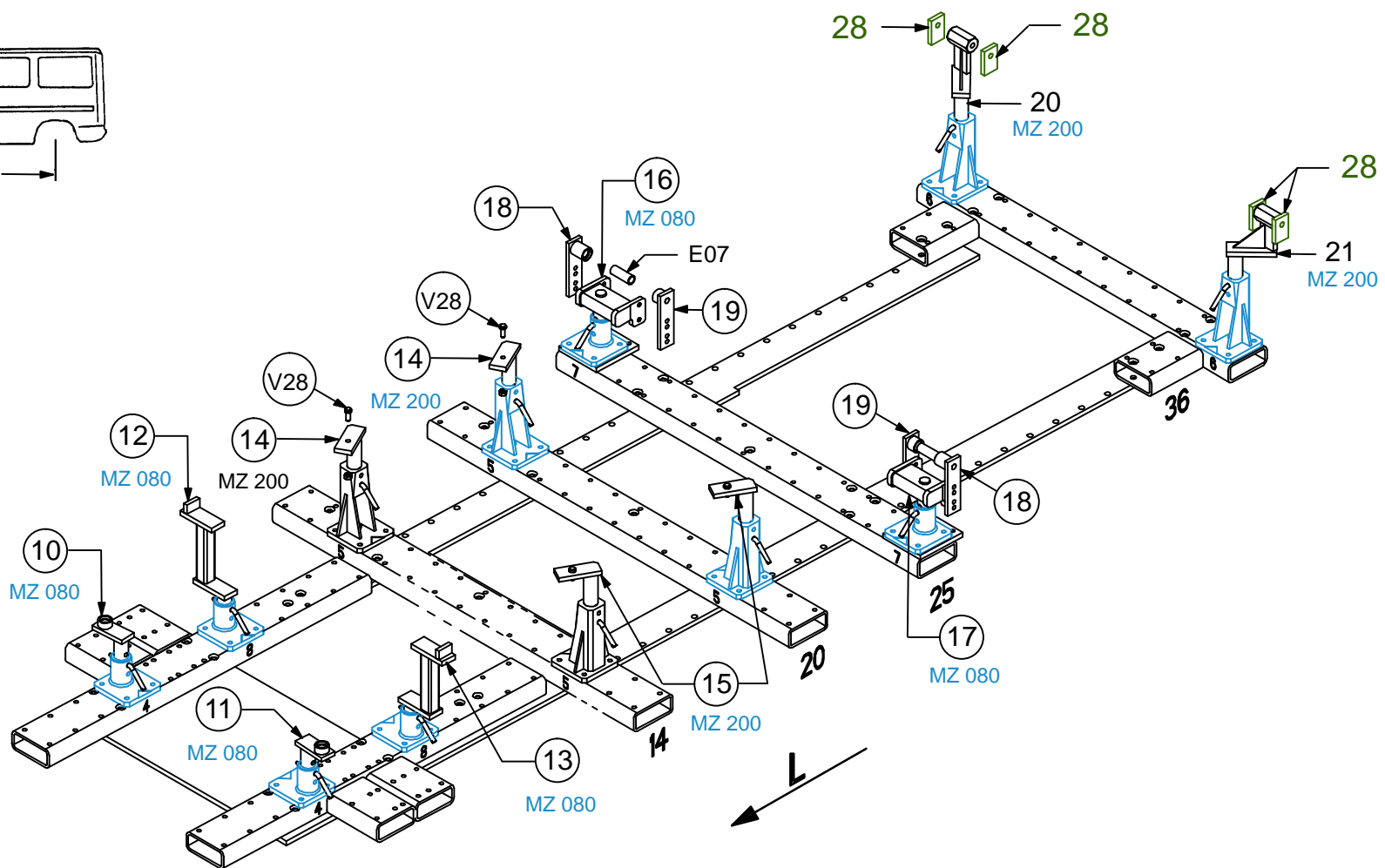
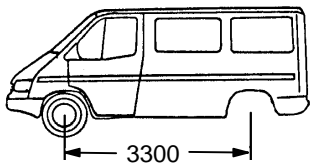

872.309-RVA3-6 00

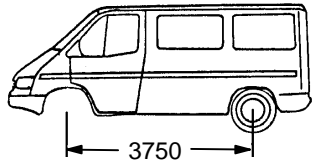

**TRACTION
FRONT WHEEL DRIVE
FRONTANTRIEB
TRAZIONE
TRACCIÓN**

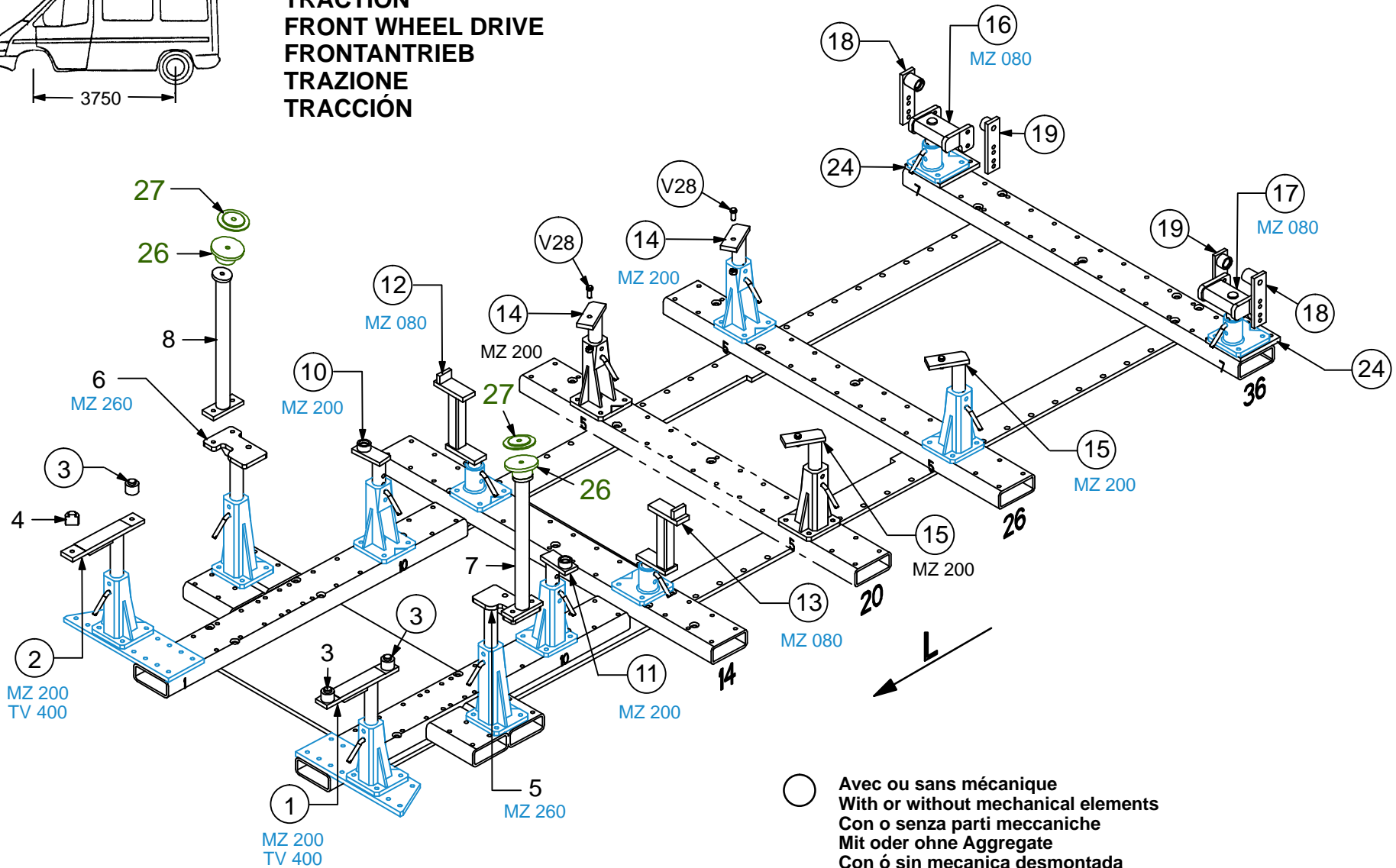

FORD

872.309

6 Kg | 21.03.2008 | 412-D-27N1

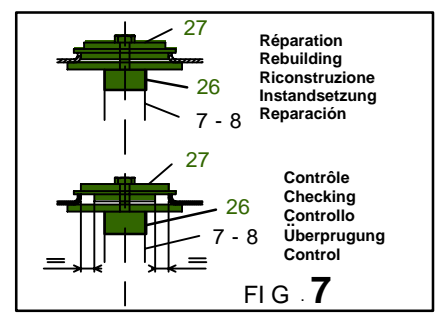
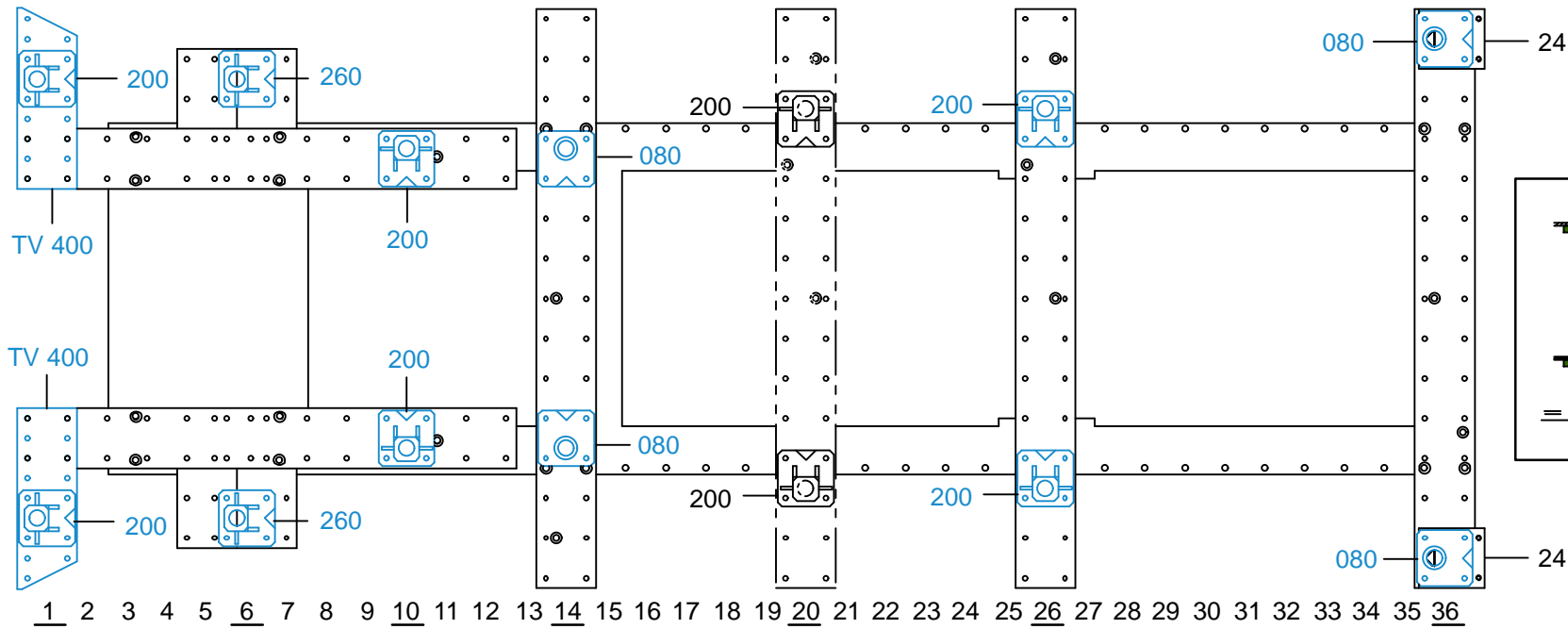
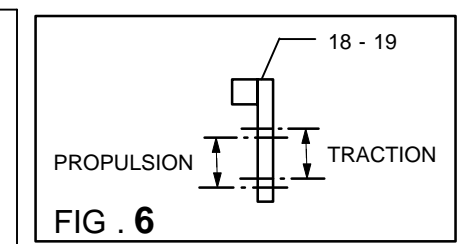
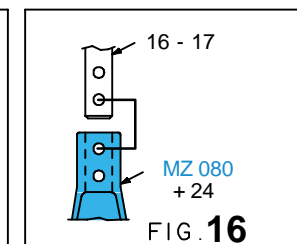
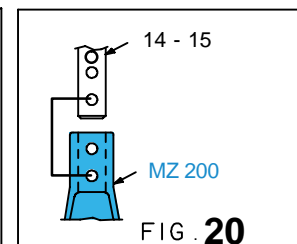
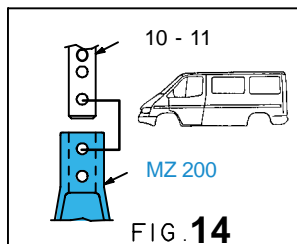
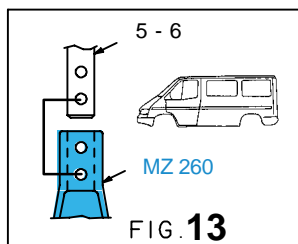
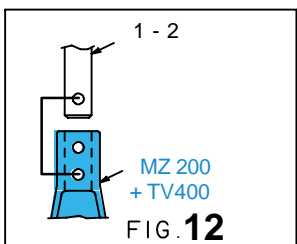
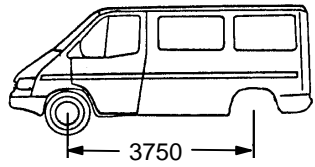

FIG. 7





**TRACTION
FRONT WHEEL DRIVE
FRONTANTRIEB
TRAZIONE
TRACCIÓN**

**M8S
MT10
SVN**

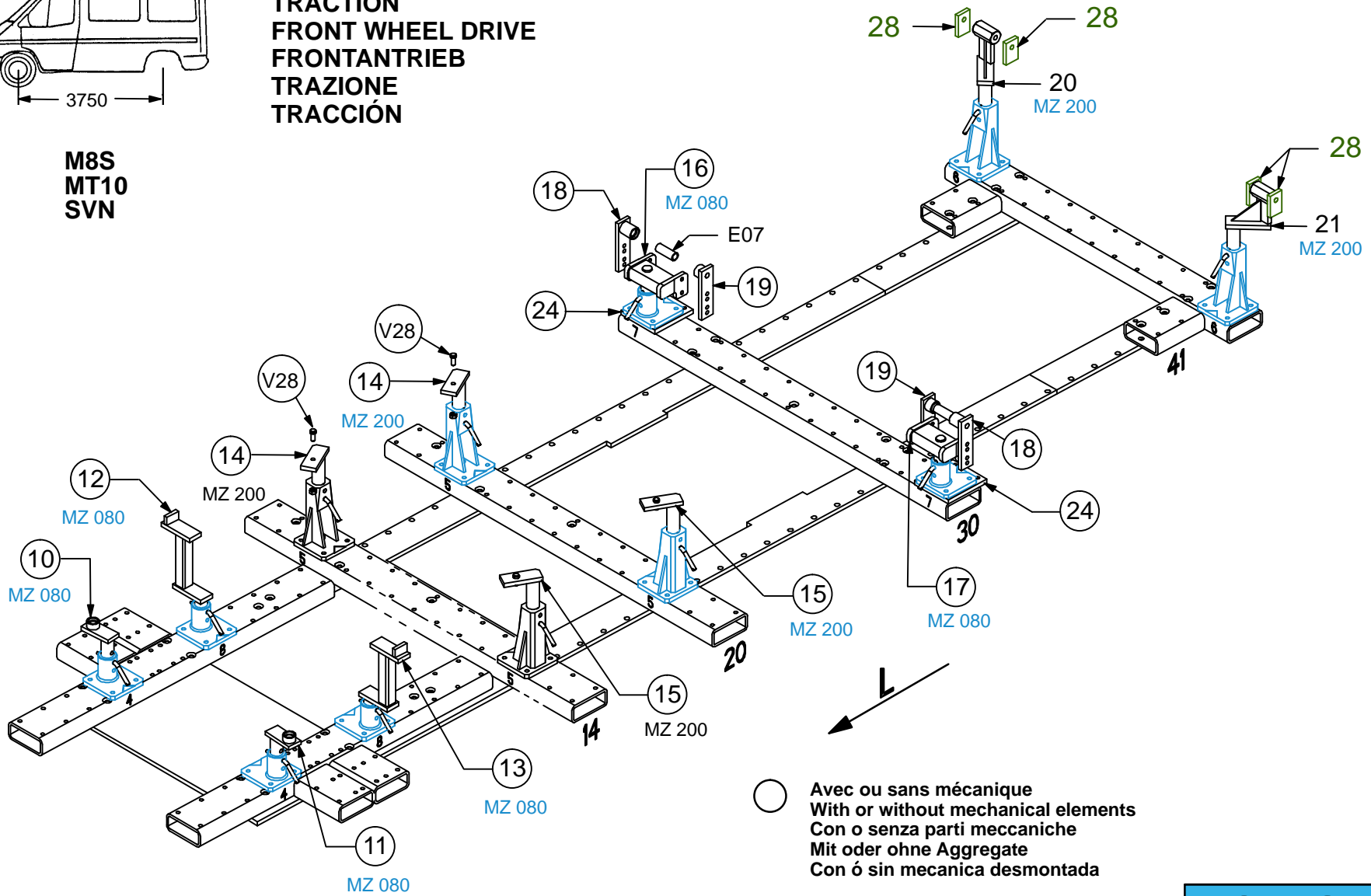

FORD

872.309

6 Kg 21.03.2008 412-D-27P1

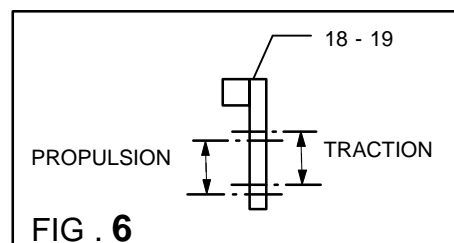
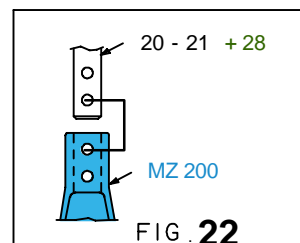
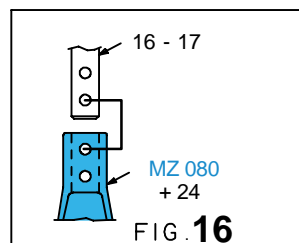
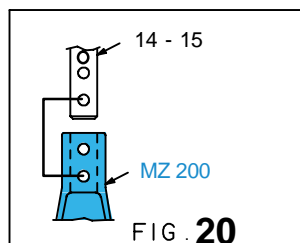
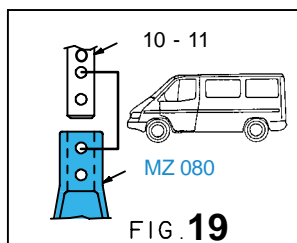
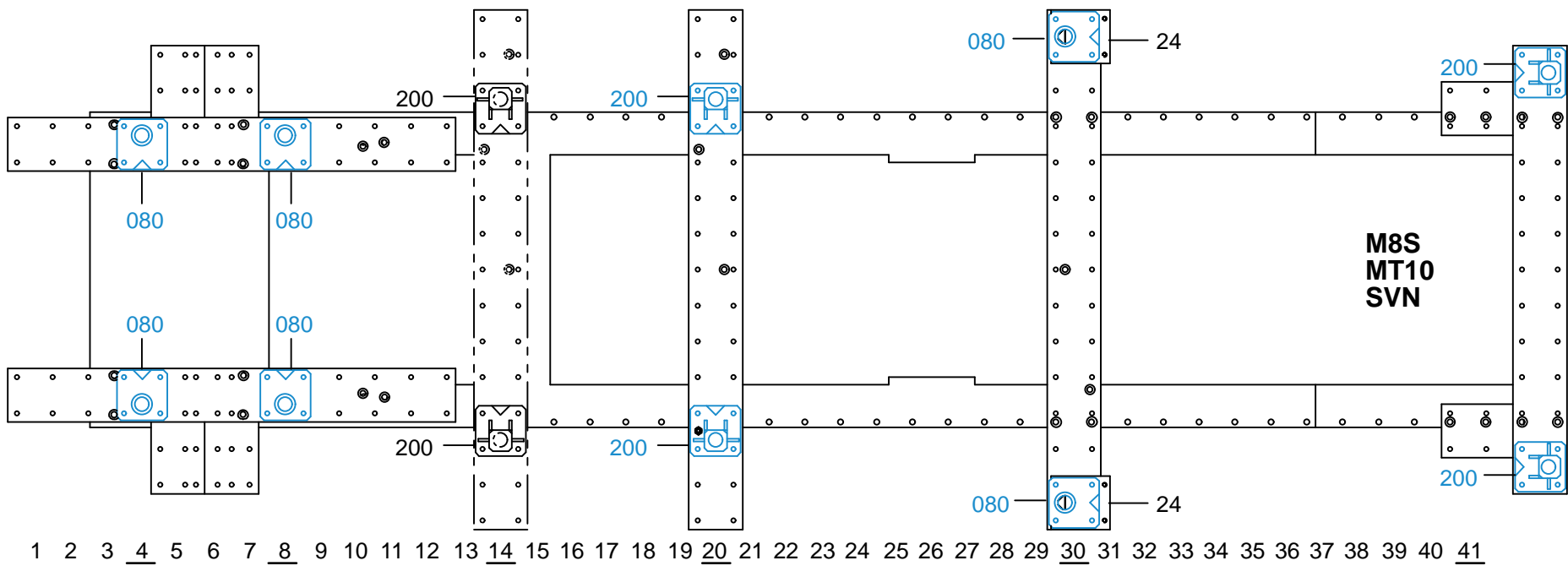

872.309-RVA3-7 01

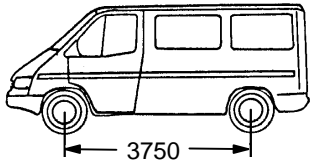

**TRACTION
FRONT WHEEL DRIVE
FRONTANTRIEB
TRAZIONE
TRACCIÓN**

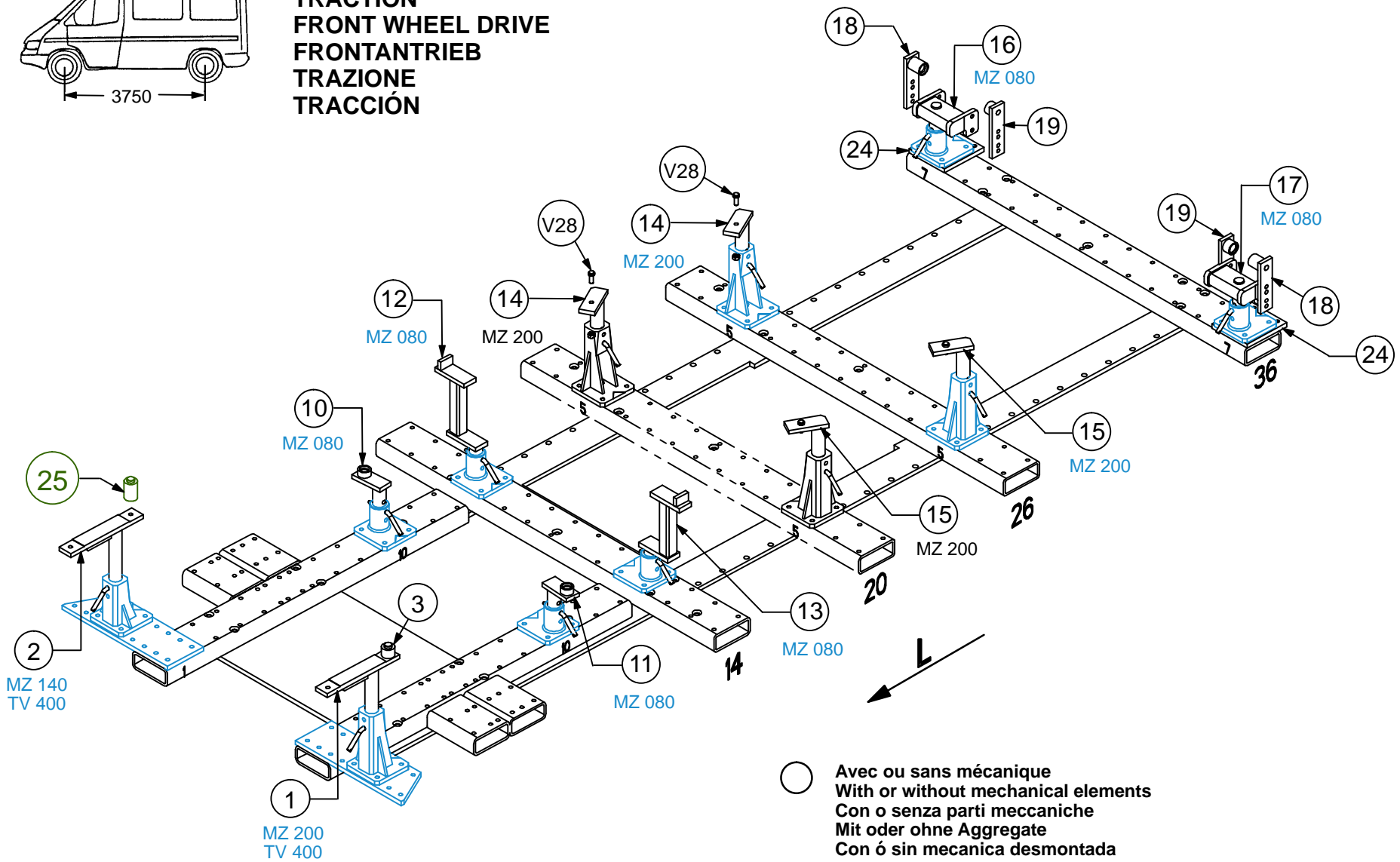

FORD

872.309

6 Kg | 21.03.2008 | 412-D-27Q1

