

M8S
MT10
SVN

**PROPULSION
REAR WHEEL DRIVE
HINTERRADANTRIEB
PROPULSIONE
PROPULSIÓN**

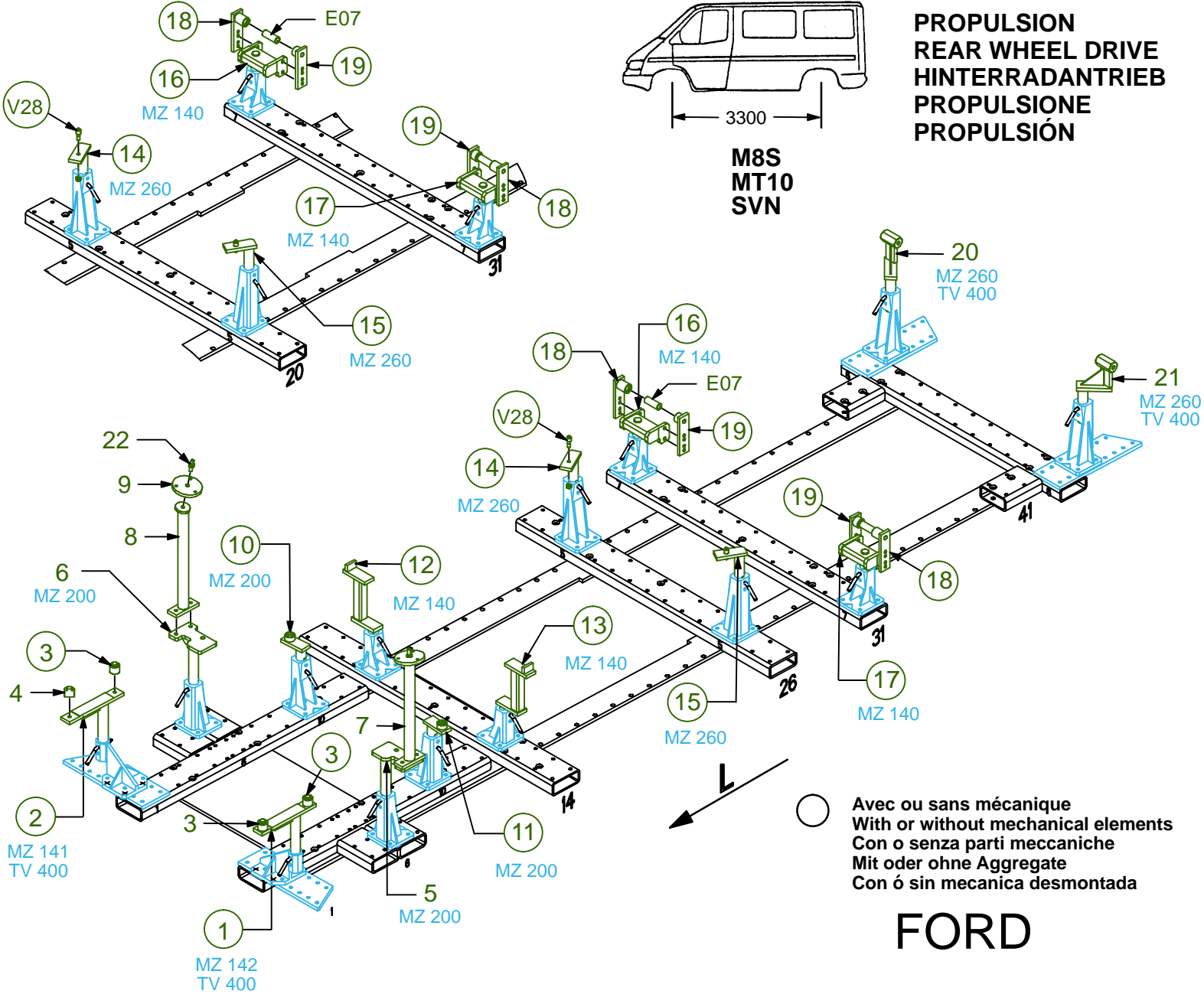

Avec ou sans mécanique
With or without mechanical elements
Con o senza parti meccaniche
Mit oder ohne Aggregate
Con ó sin mecanica desmontada

REP.	REFERENCE	PDS	NB	MZ
1	872.7001	4,3	1	142/200
2	872.7002	4,3	1	141/200
3	872.7003	0,3	3	
4	872.7004	0,3	1	
5	872.7005	4,3	1	200/260
6	872.7006	4,3	1	200/260
7	872.7007	2,2	1	
8	872.7008	2,2	1	
9	872.7009	1,0	2	
10	872.7010	1,8	1	080/200
11	872.7011	1,8	1	080/200
12	872.7012	3,0	1	140/080
13	872.7013	3,0	1	140/080
14	872.7014	2,4	1	200/260
15	872.7015	2,4	1	200/260
16	872.7016	3,7	1	080/140
17	872.7017	3,7	1	080/140
18	872.7018	1,0	2	
19	872.7019	0,9	2	
20	872.7020	3,7	1	200/260
21	872.7021	3,7	1	200/260
22	872.7022	0,1	2	
23	872.7023	3,2	2	
24	872.7024	2,8	4	
	E07	0,1	2	
	V28	0,1	2	

M 8-25	6
M 12-25	24
M 12-30	12
M 12-45	4
M 16-70	2
M 16-200	2
CHc 12-25 TB	20
MU 12	2
M 8	6
M 12	6

FORD

872.300

78 Kg 11.05.2001 412-D-27A

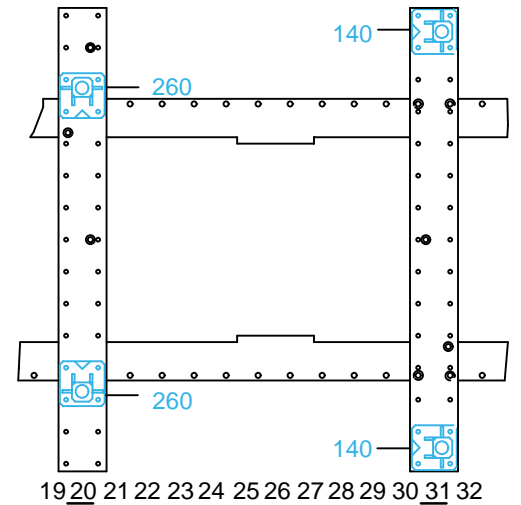
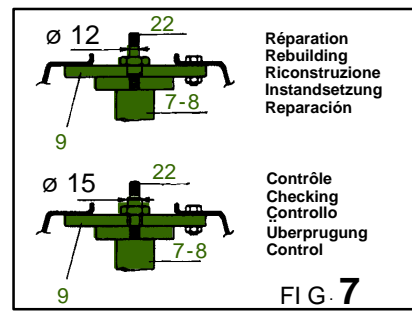
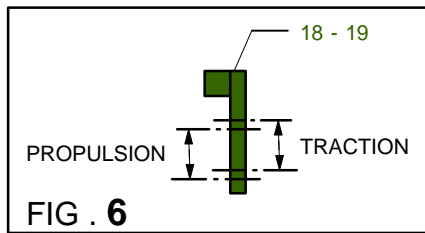
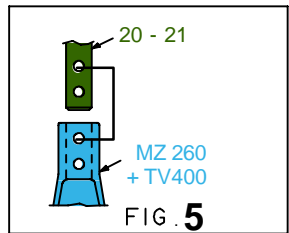
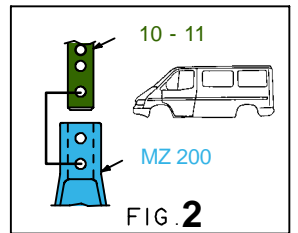
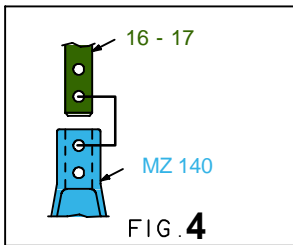
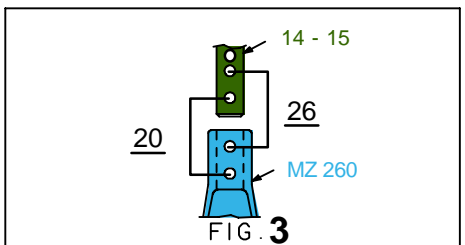
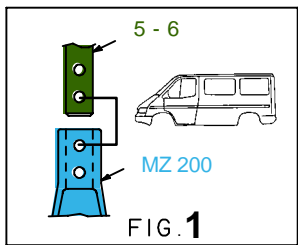
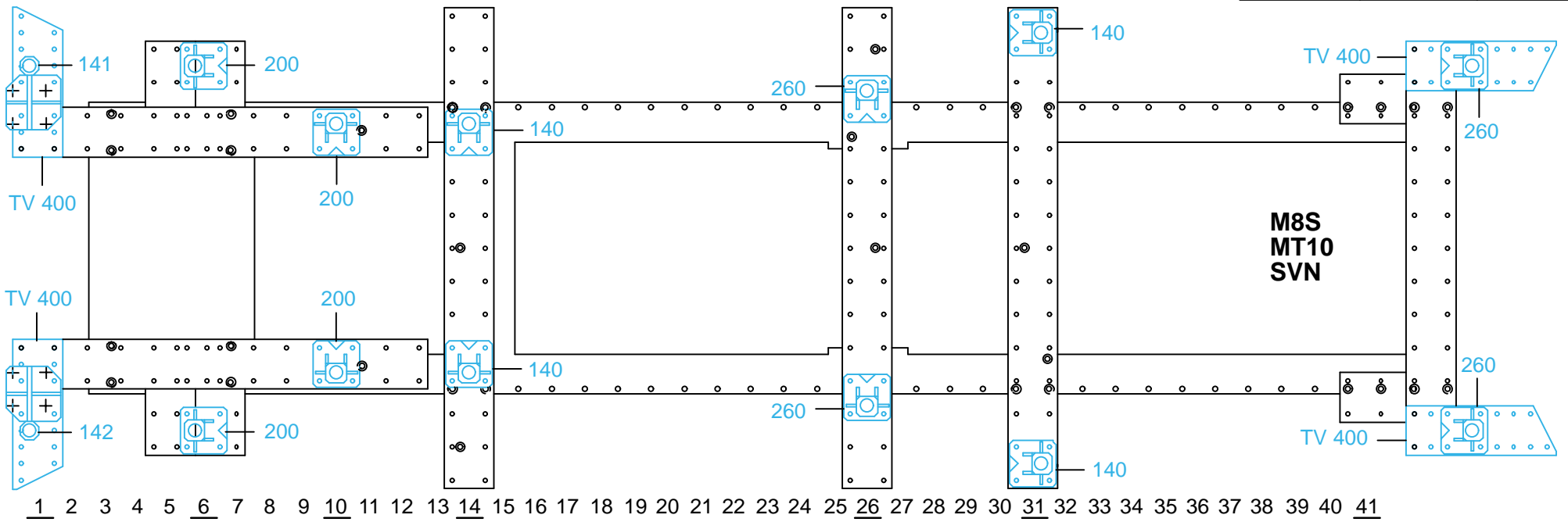

**PROPULSION
REAR WHEEL DRIVE
HINTERRADANTRIEB
PROPULSIONE
PROPULSIÓN**

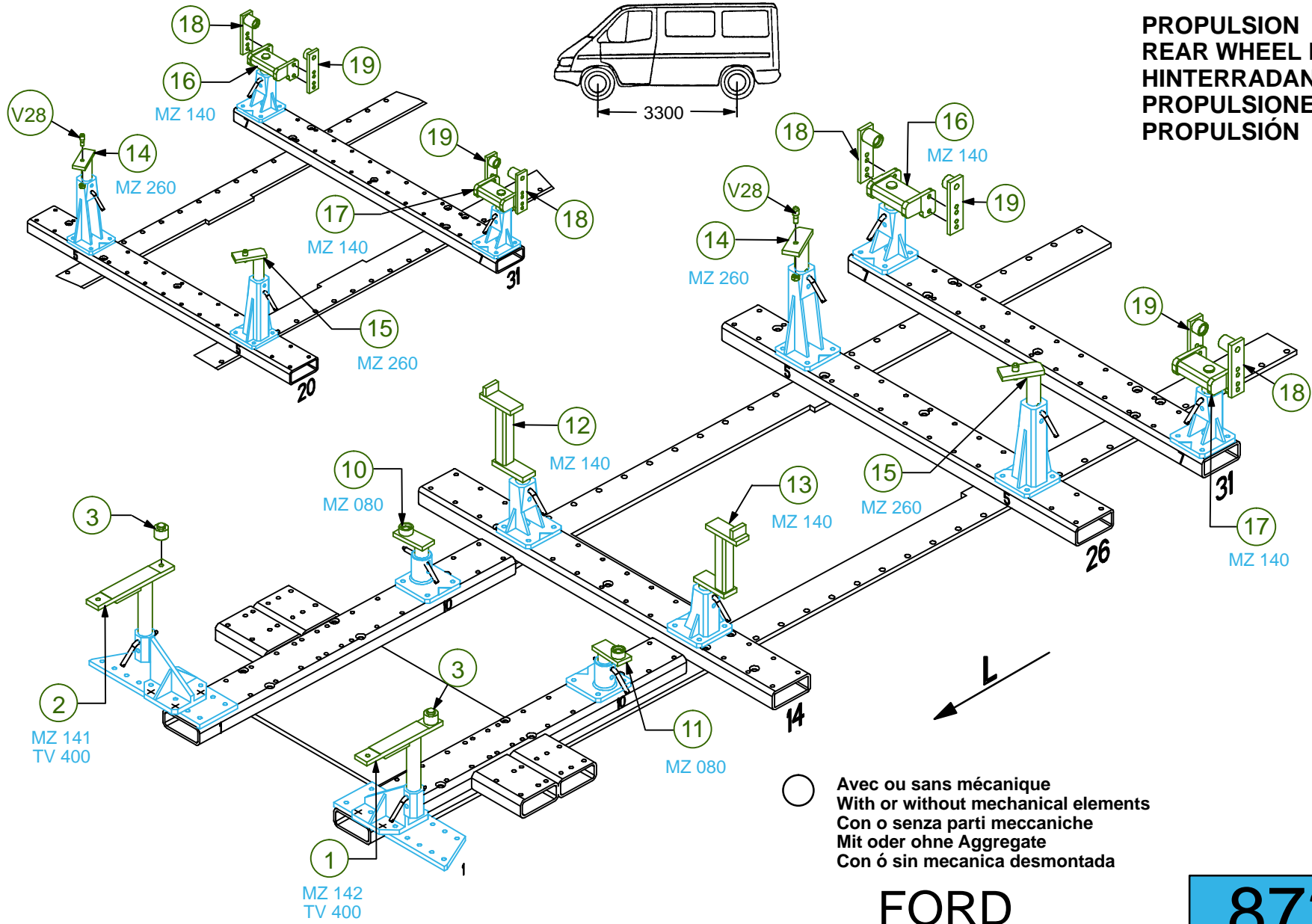

FORD

872.300

78 Kg 11.05.2001 412-D-27B

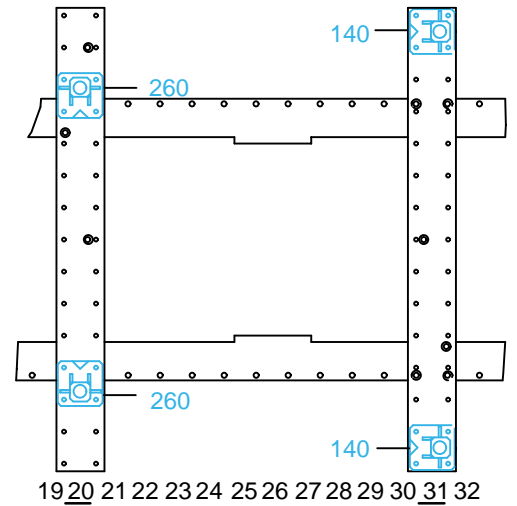
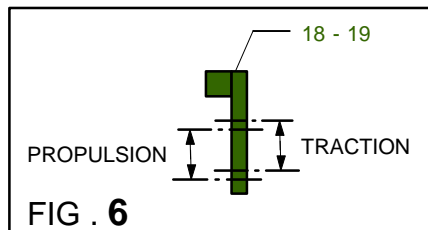
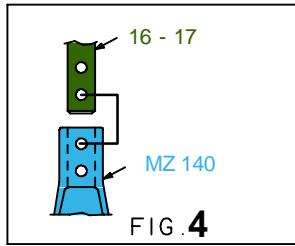
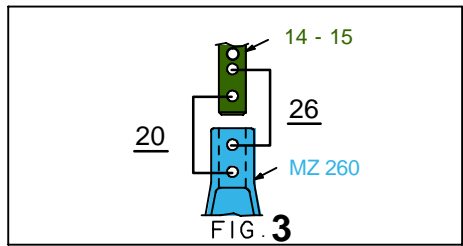
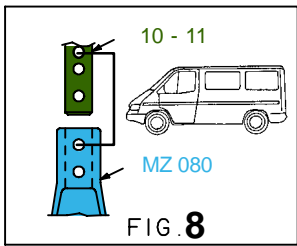
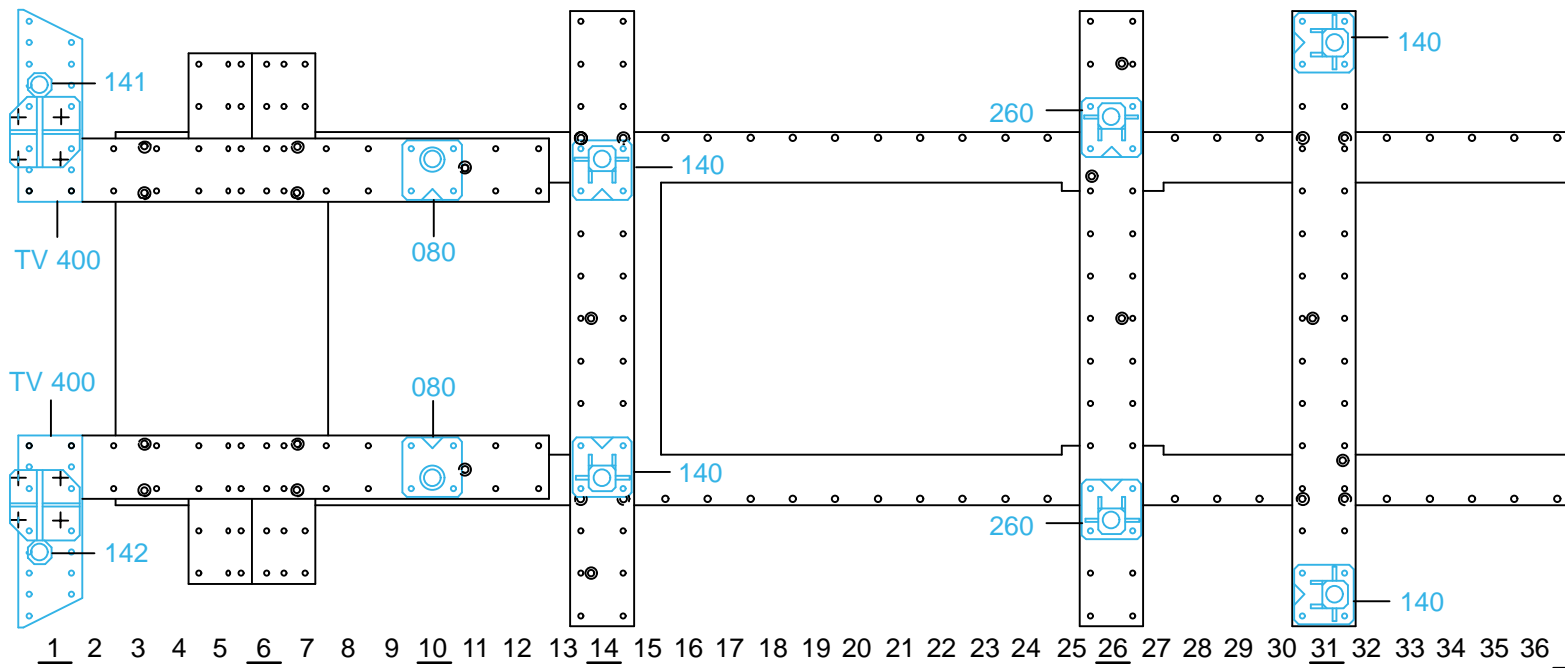

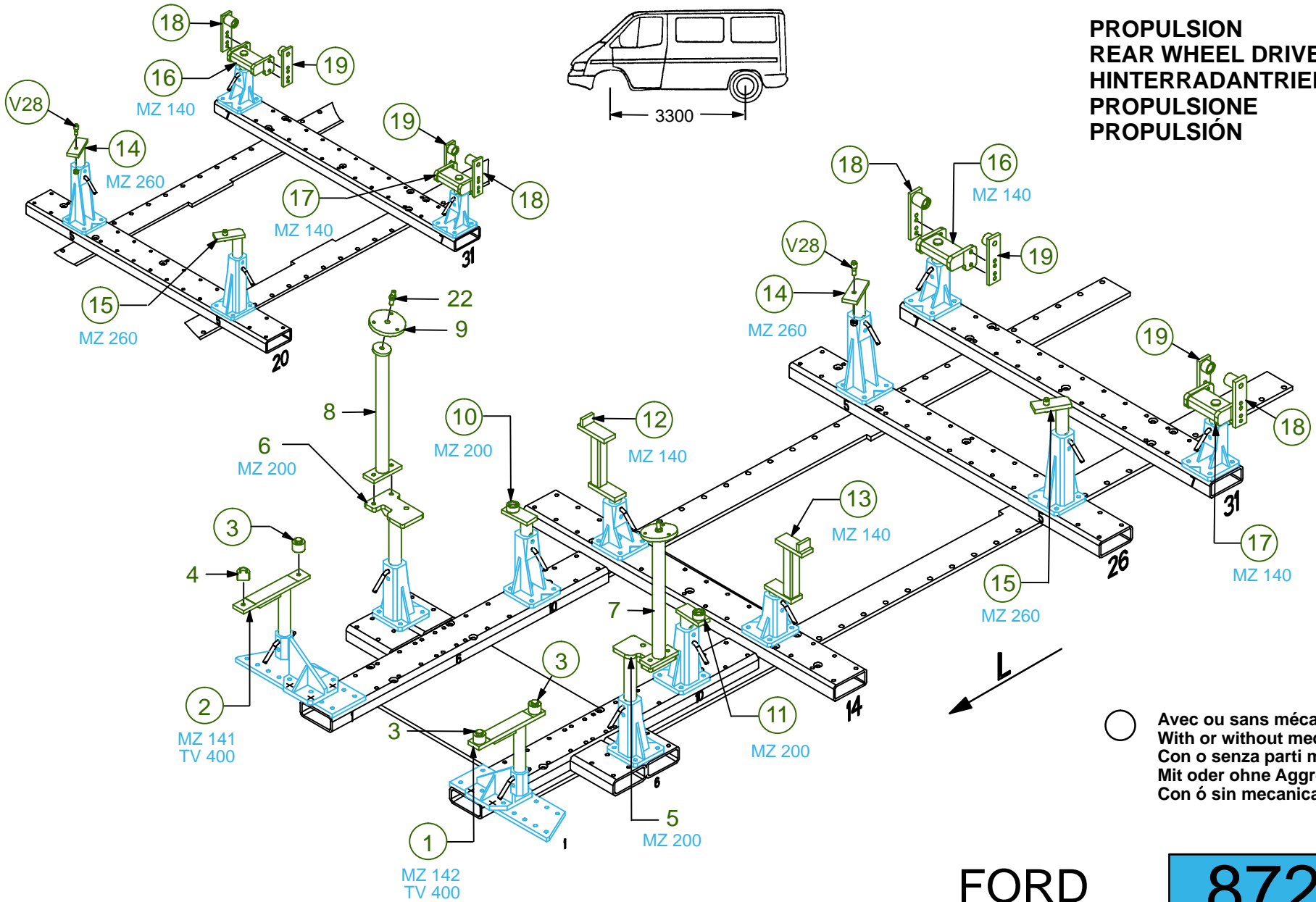

**PROPULSION
REAR WHEEL DRIVE
HINTERRADANTRIEB
PROPULSIONE
PROPULSIÓN**

FORD

872.300

78 Kg 11.05.2001 412-D-27C

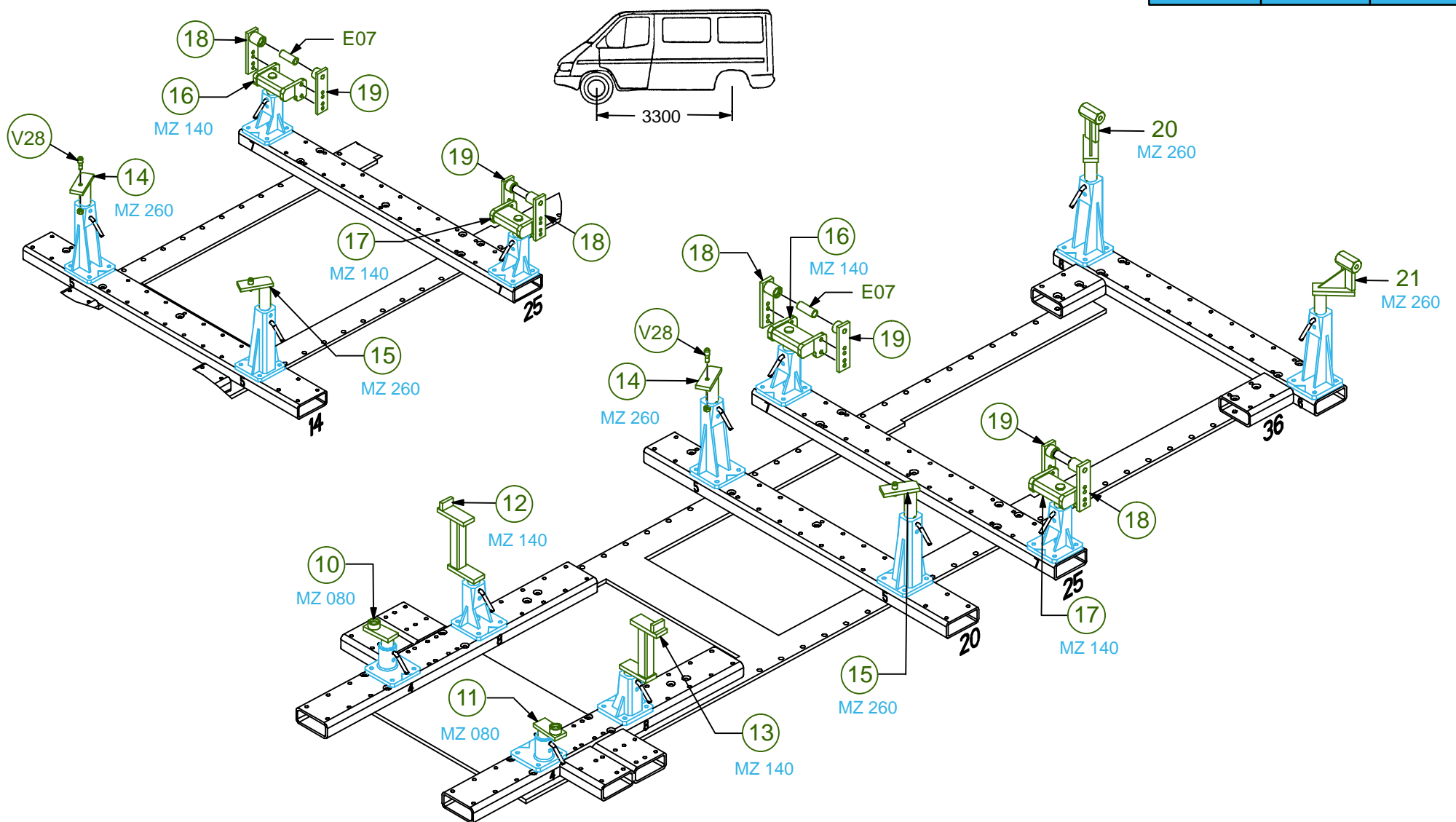

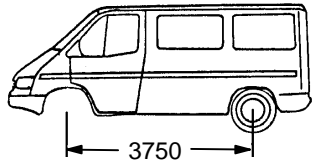

**PROPULSION
REAR WHEEL DRIVE
HINTERRADANTRIEB
PROPULSIONE
PROPULSIÓN**

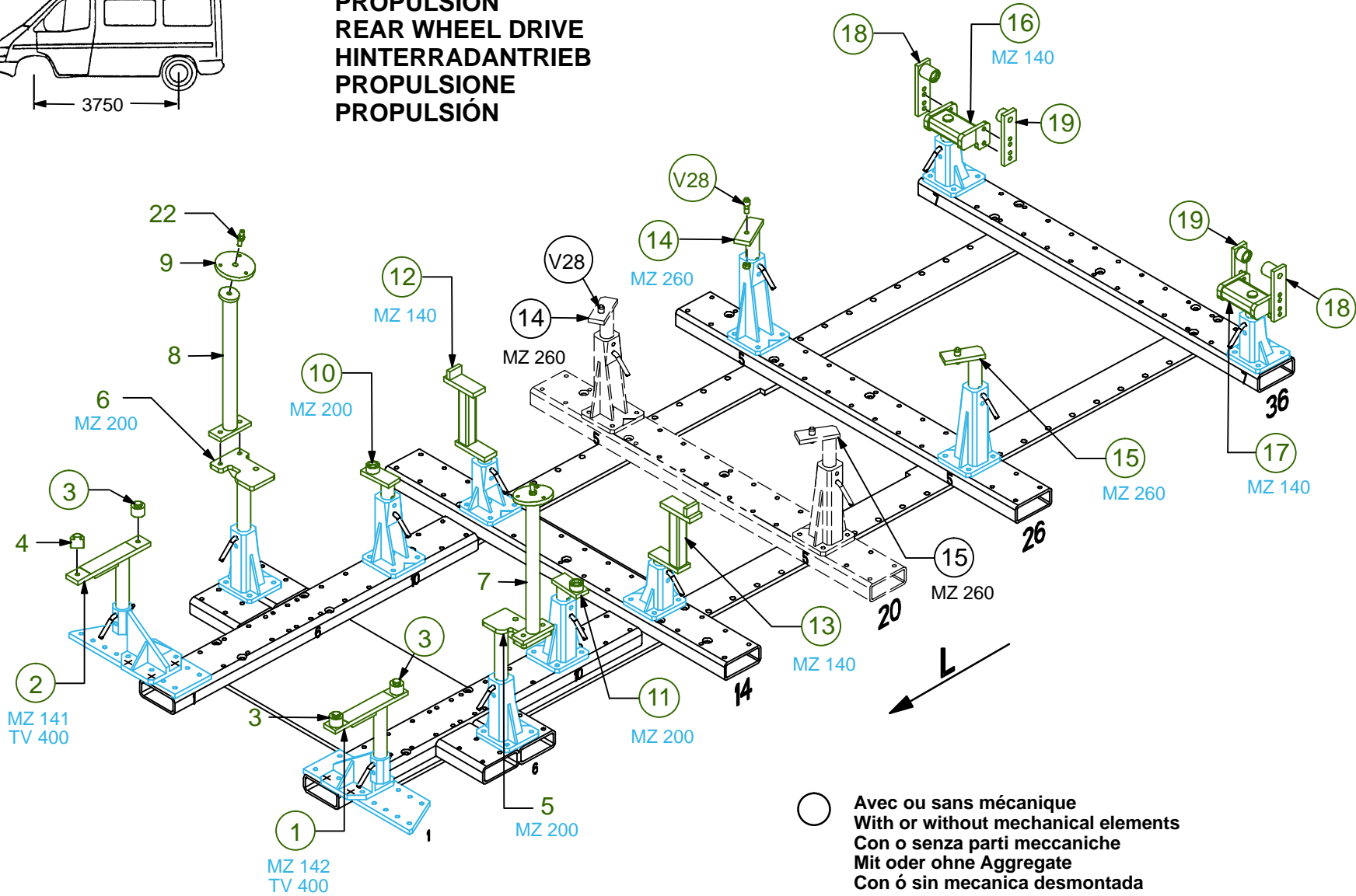

FORD

872.300

78 Kg | 11.05.2001 | 412-D-27D

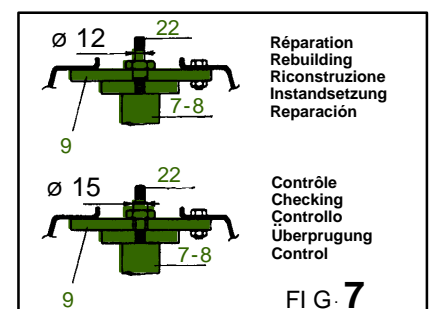
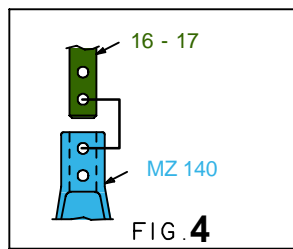
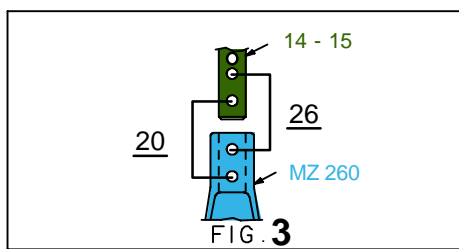
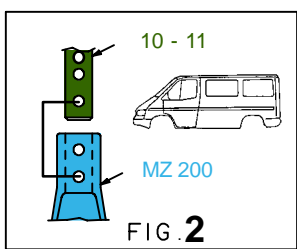
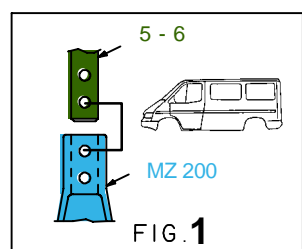
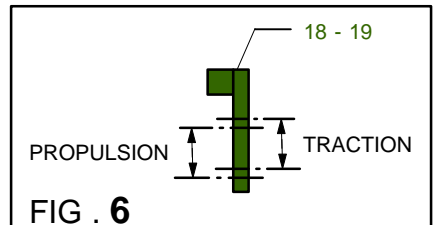
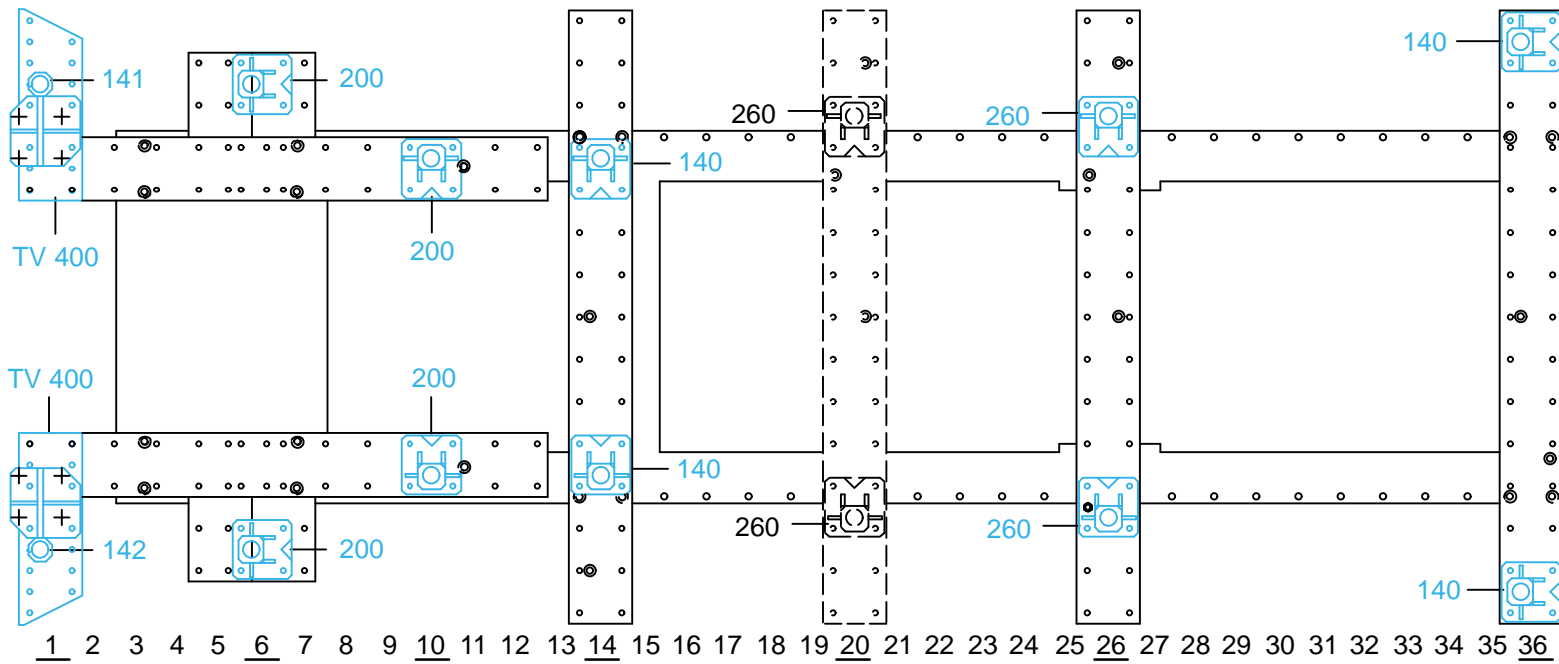

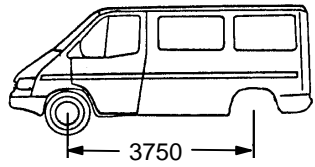

**PROPULSION
REAR WHEEL DRIVE
HINTERRADANTRIEB
PROPULSIONE
PROPULSIÓN**

**M8S
MT10
SVN**

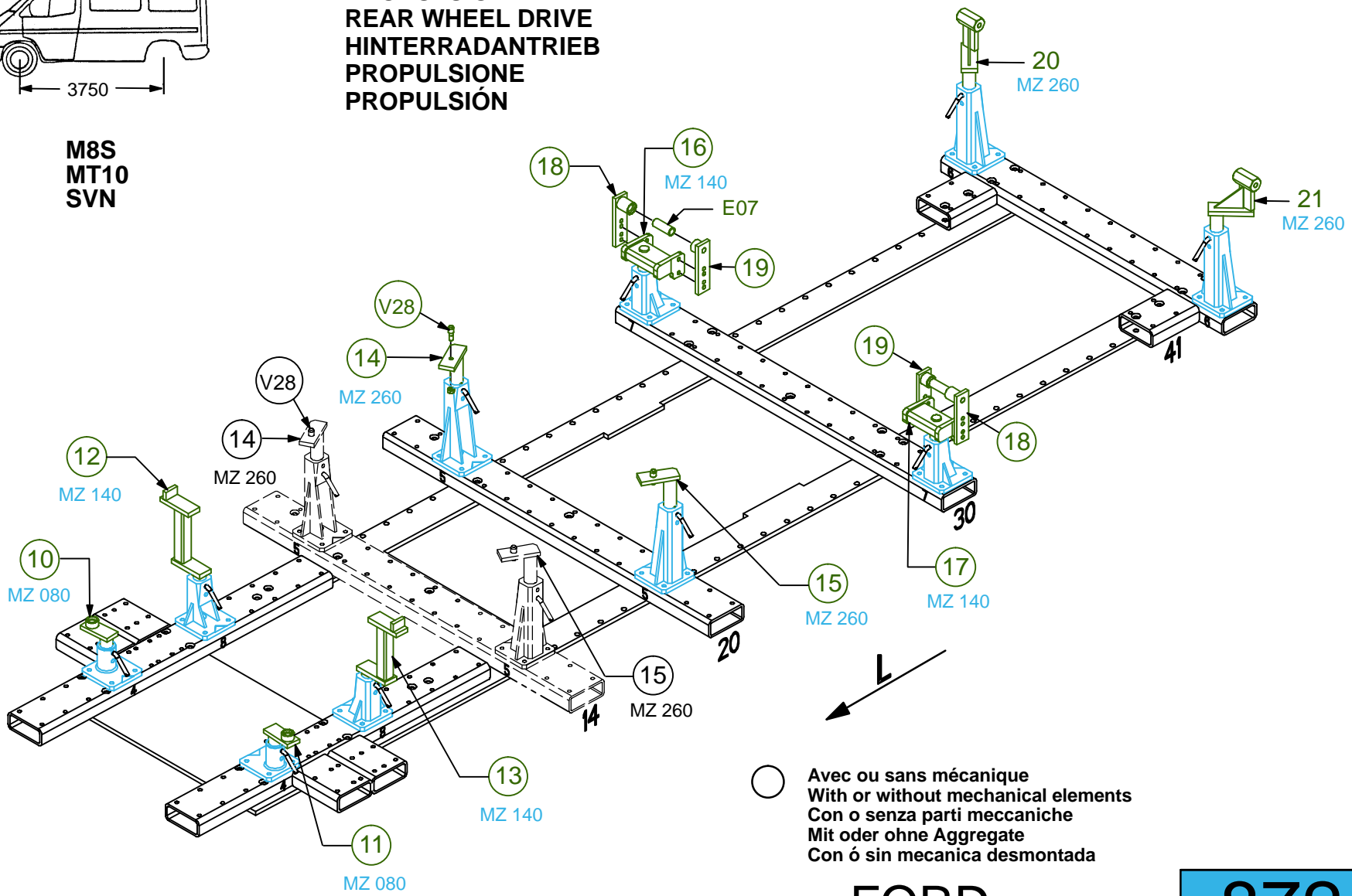

FORD

872.300

78 Kg 11.05.2001 412-D-27E

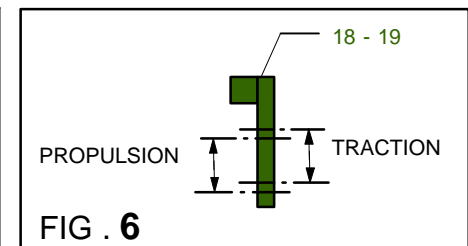
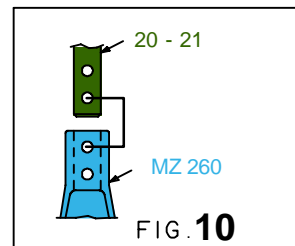
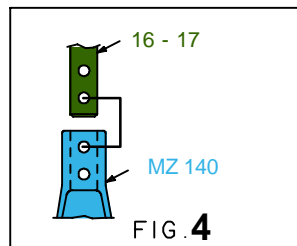
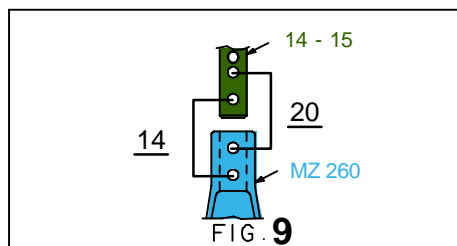
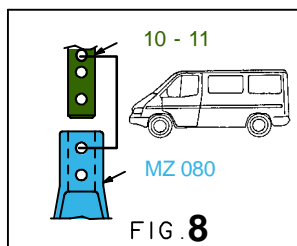
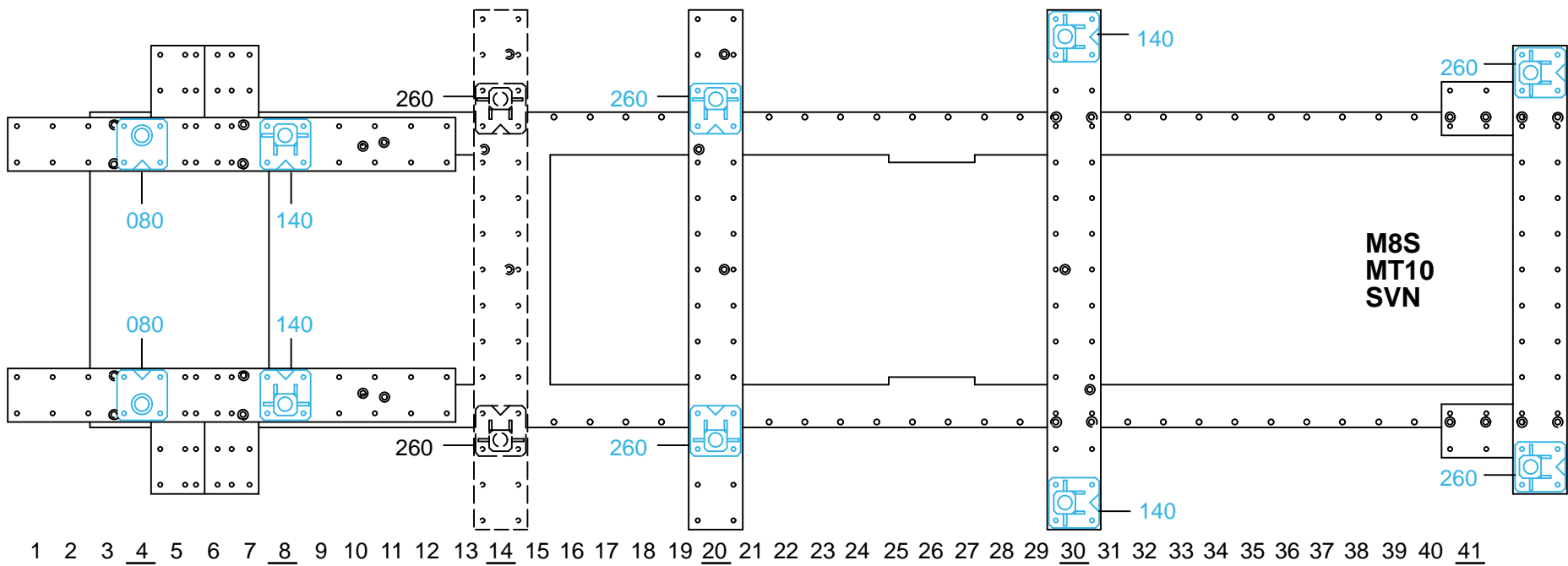

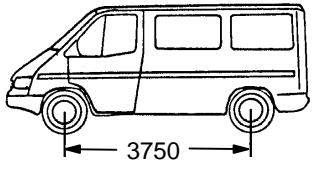

**PROPULSION
REAR WHEEL DRIVE
HINTERRADANTRIEB
PROPULSIONE
PROPULSIÓN**

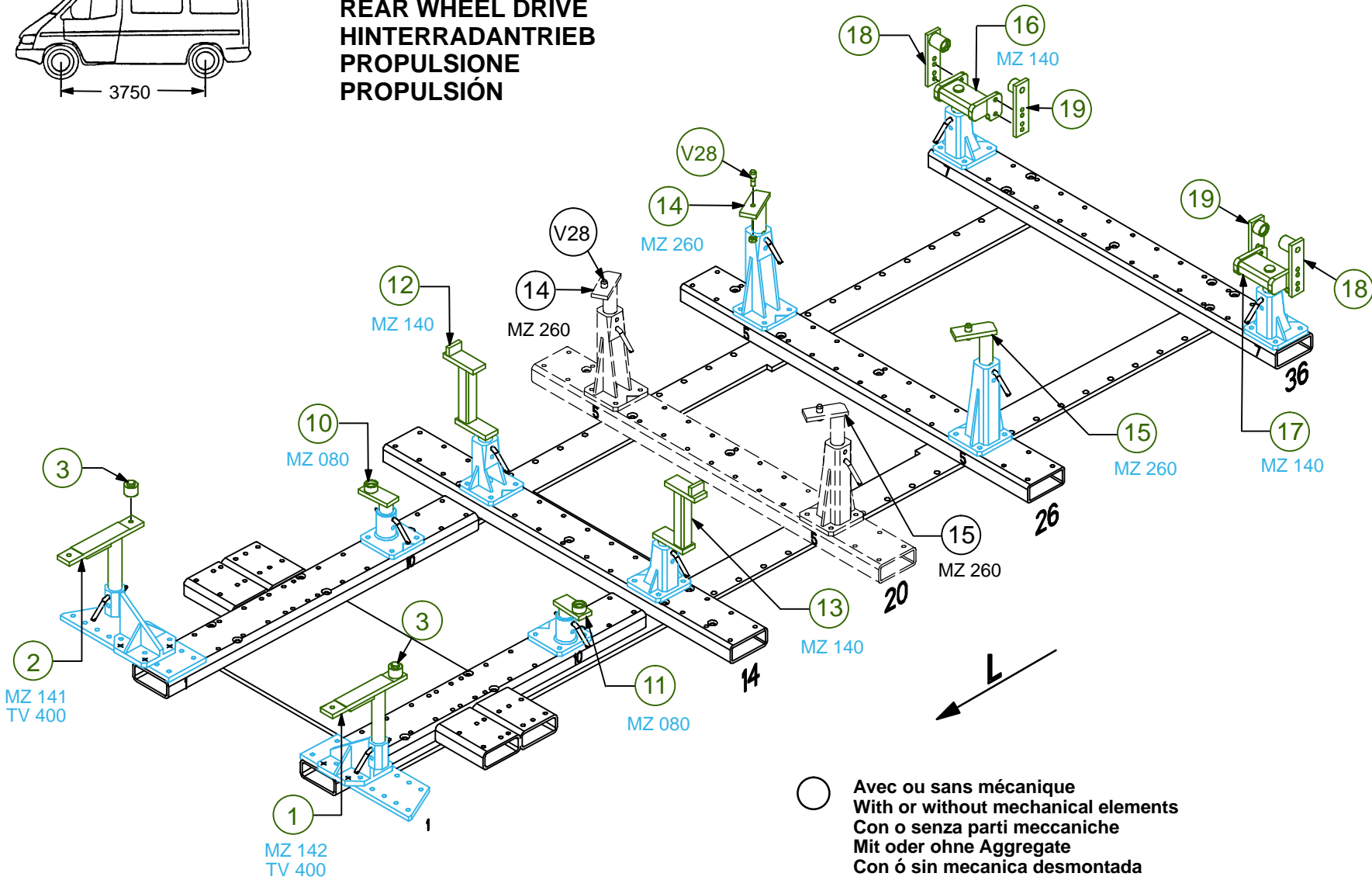

FORD

872.300

78 Kg

11.05.2001

412-D-27F

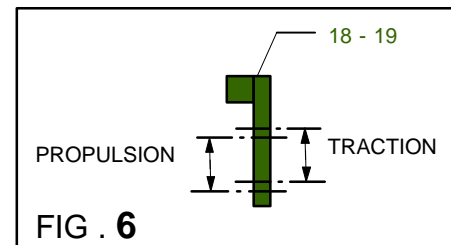
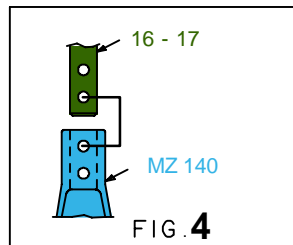
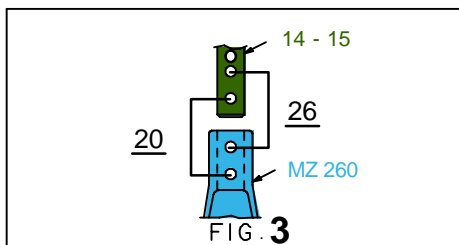
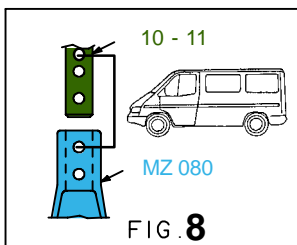
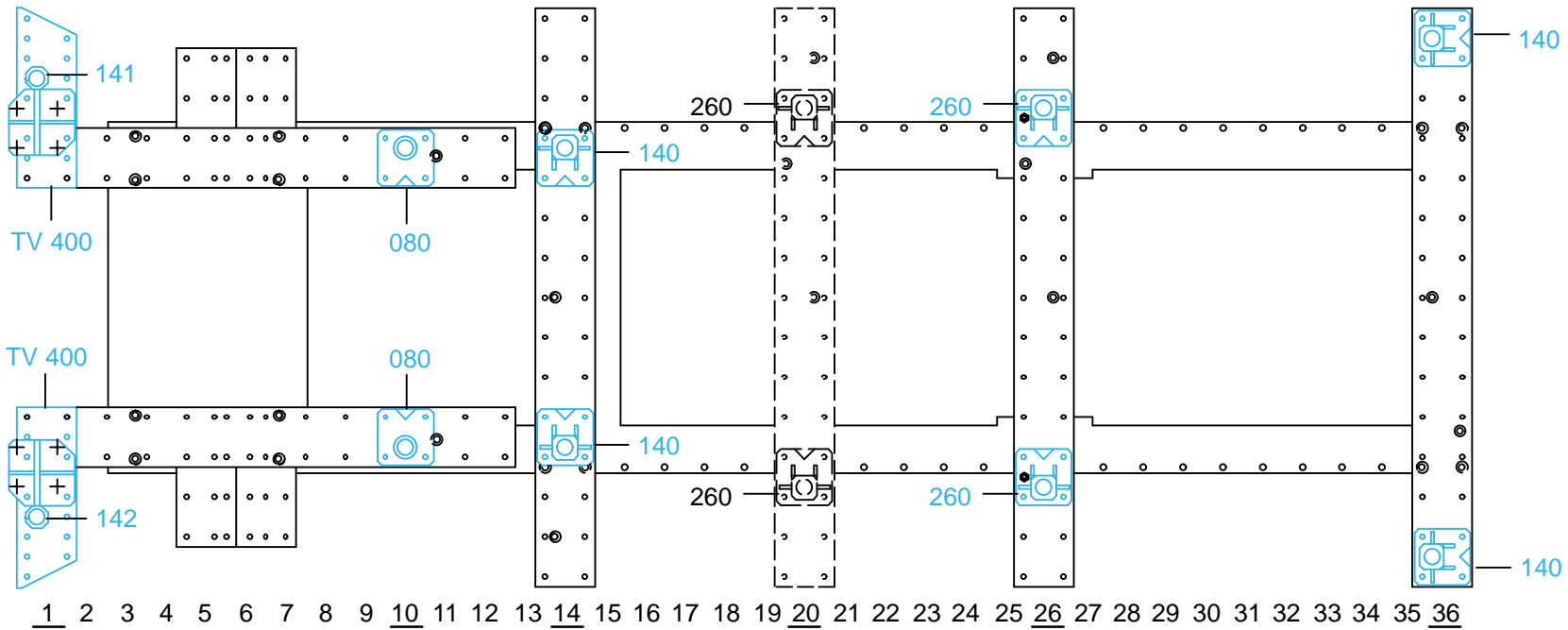

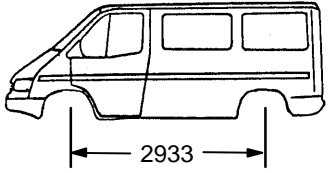

**TRACTION
FRONT WHEEL DRIVE
FRONTANTRIEB
TRAZIONE
TRACCIÓN**

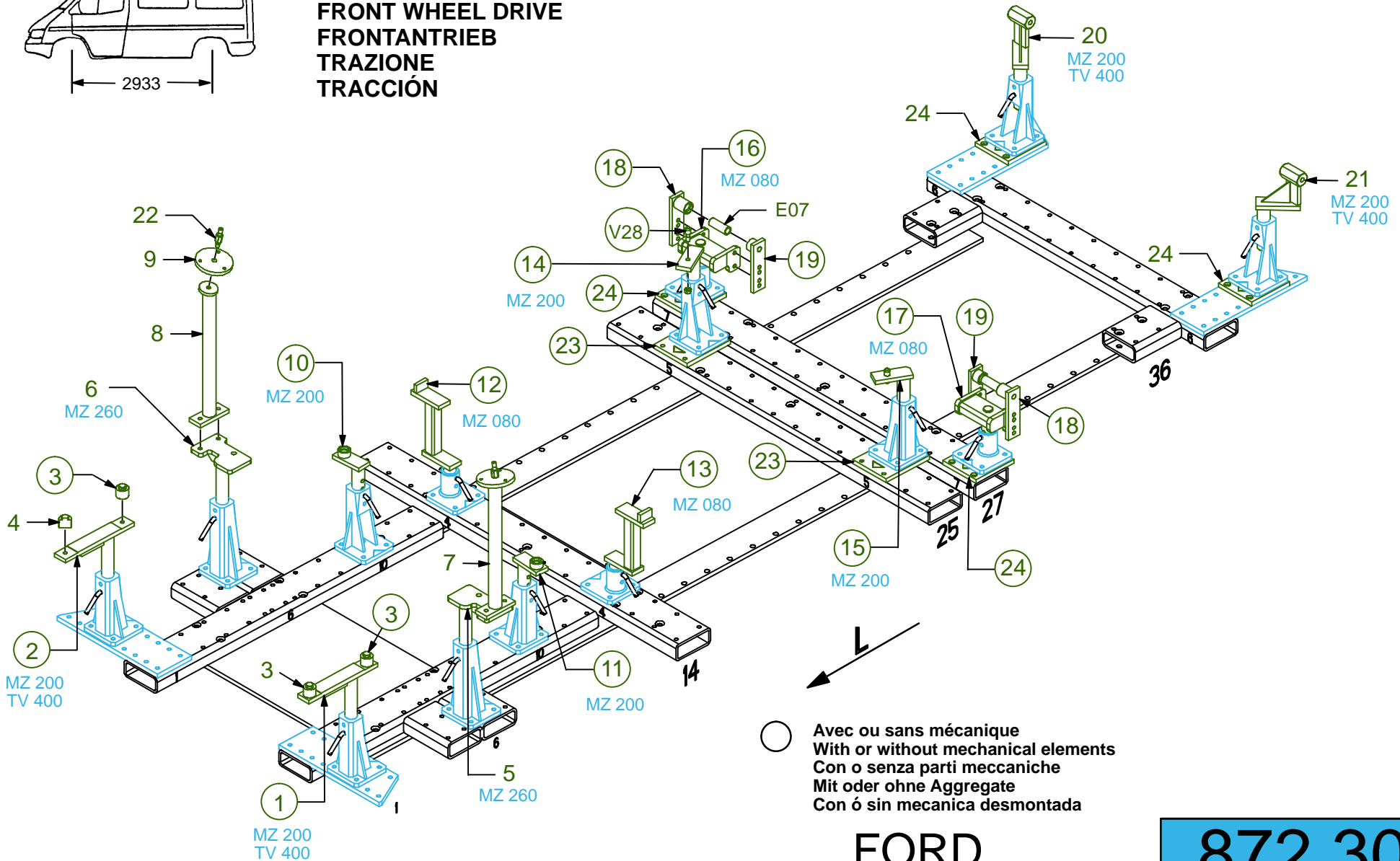

○ Avec ou sans mécanique
With or without mechanical elements
Con o senza parti meccaniche
Mit oder ohne Aggregate
Con ó sin mecanica desmontada

FORD

872.300

78 Kg 11.05.2001 412-D-27G

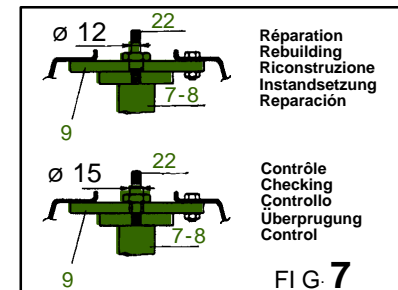
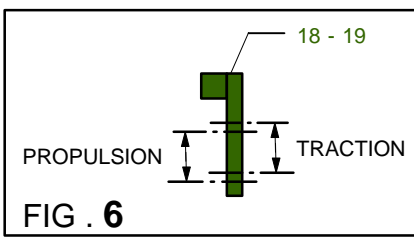
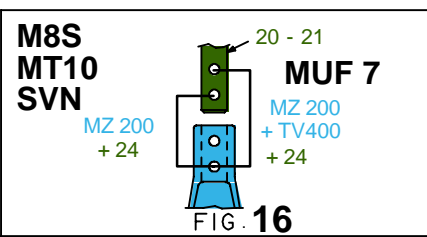
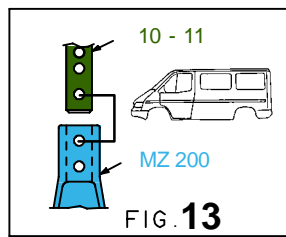
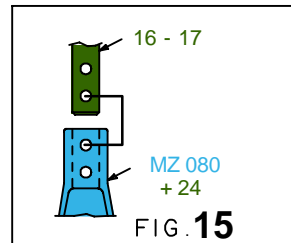
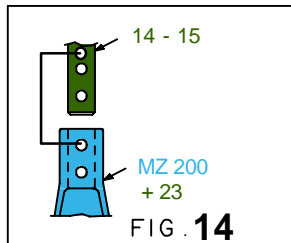
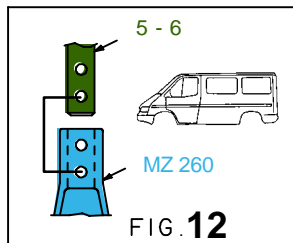
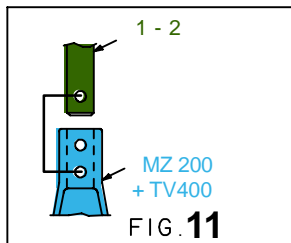
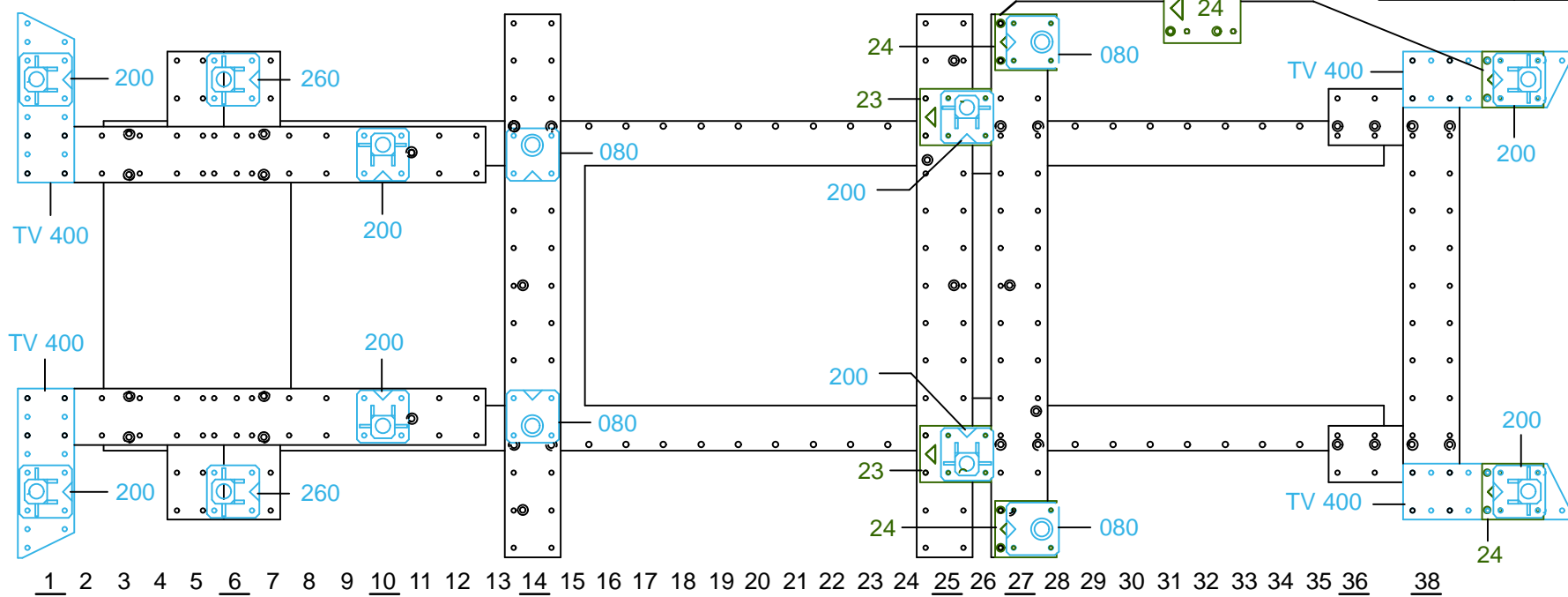

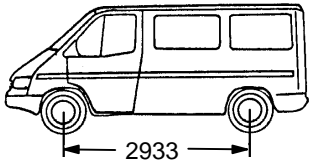

**TRACTION
FRONT WHEEL DRIVE
FRONTANTRIEB
TRAZIONE
TRACCIÓN**

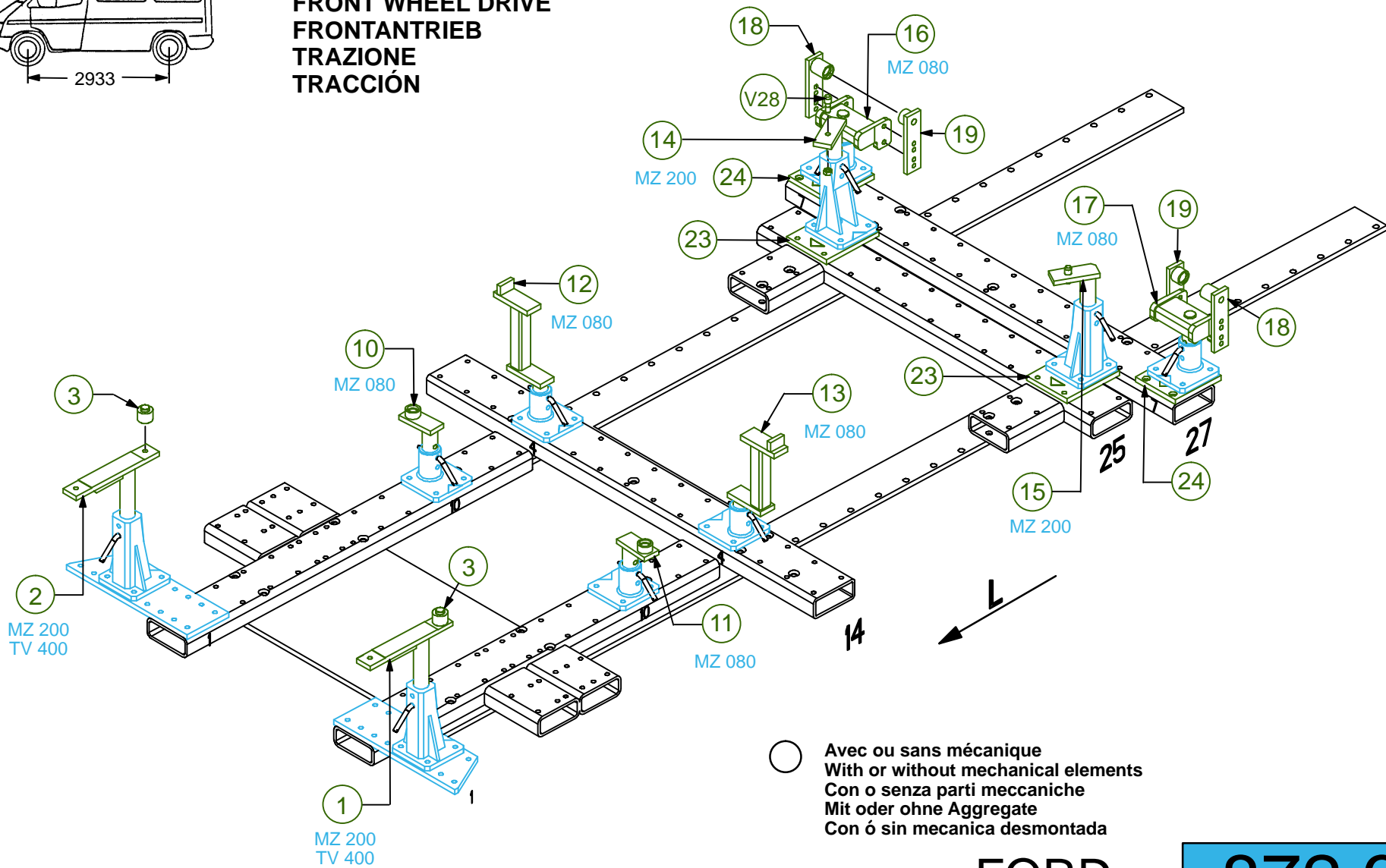

FORD

872.300

78 Kg

11.05.2001

412-D-27H

