

Choc avant
Front crash
Frontreparatur
Urto anteriore
Choque delantero

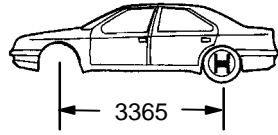

**M8S
MT10
SVN**

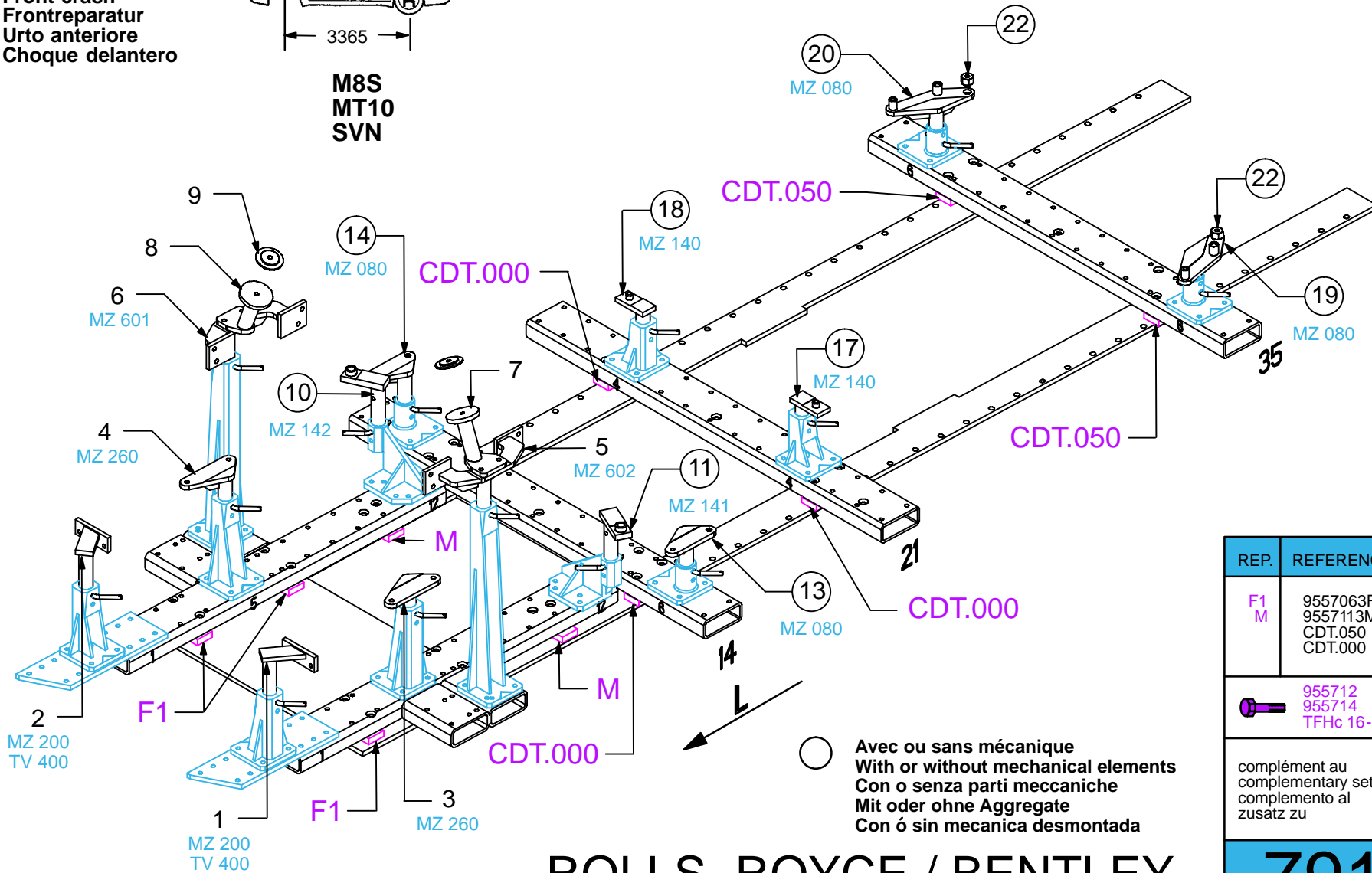

REP.	REFERENCE	PDS	NB	MZ
F1	9557063F1	1,9	4	
M	9557113M	1,9	2	
	CDT.050	1,7	4	
	CDT.000	1,3	4	

955712	18
955714	8
TFHc 16-60	8

complément au
complementary set to
complemento al
zusatz zu **791.300**

791.309

26 Kg 03.04.2003 428-D-2C

ROLLS ROYCE / BENTLEY

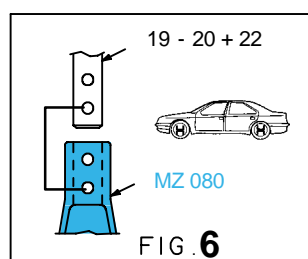
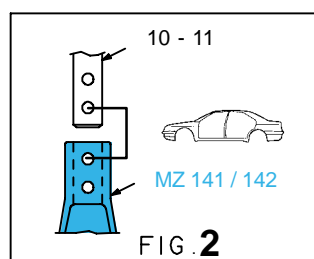
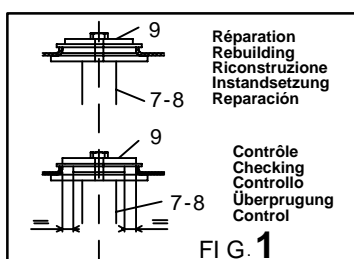
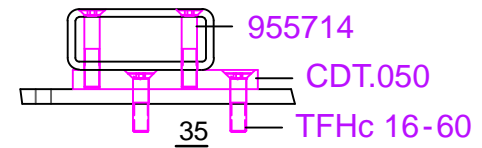
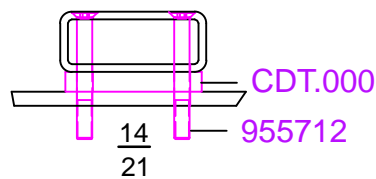
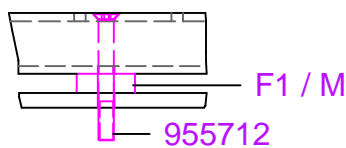
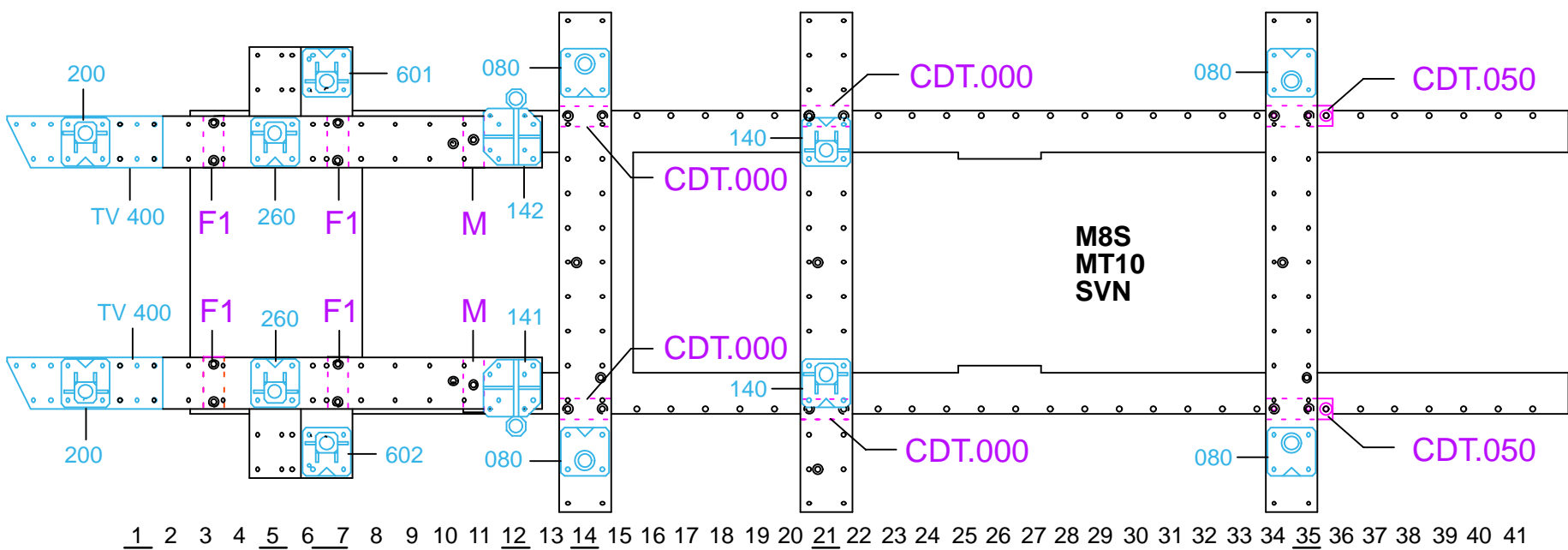

791.309-RVA3-1 00

Choc arrière
Rear crash
Heckreparatur
Urto posteriore
Choque trasero

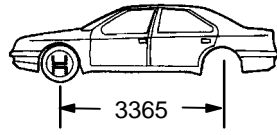

M8S
MT10
SVN

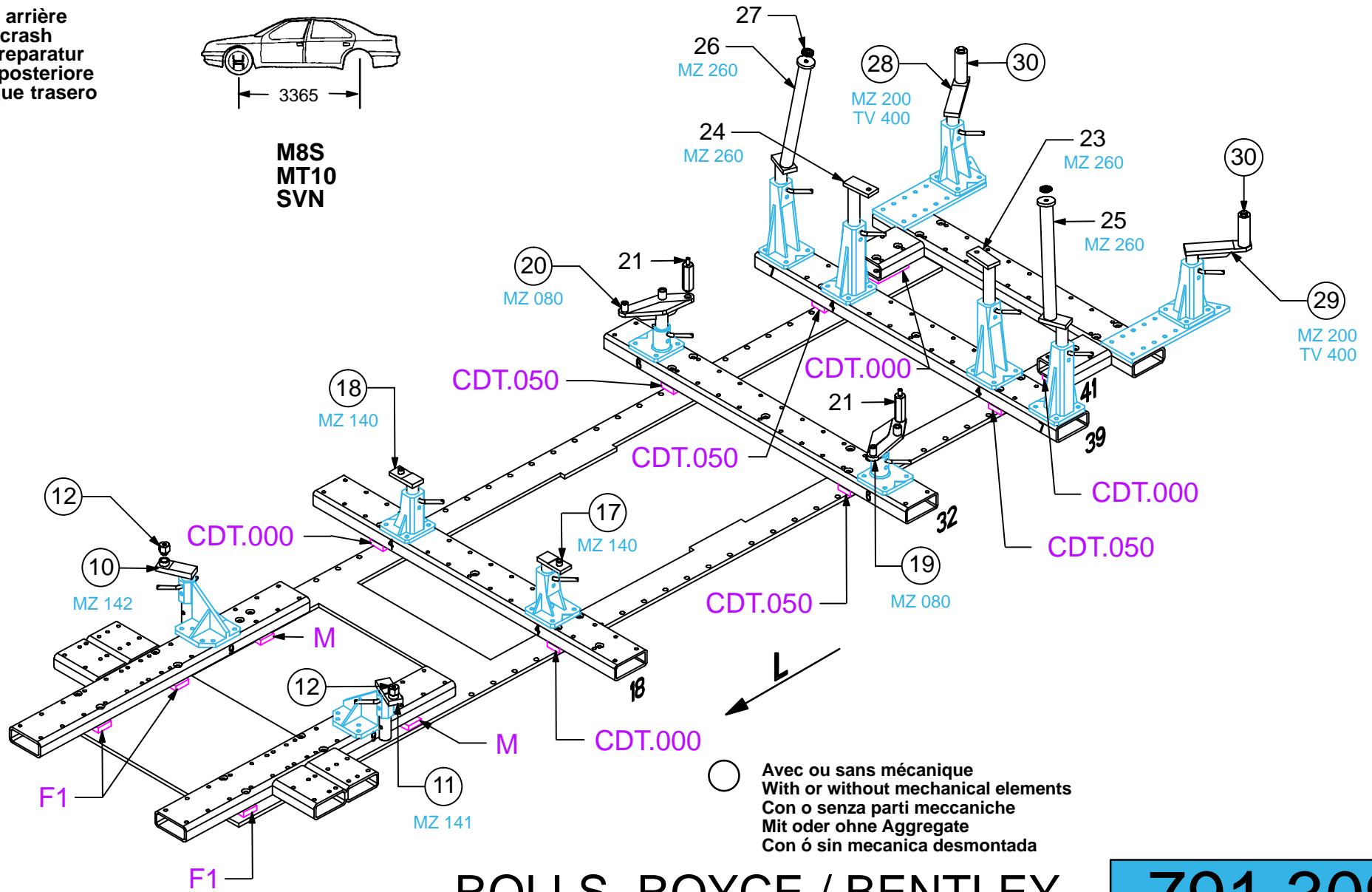

ROLLS ROYCE / BENTLEY

791.309

26 Kg | 03.04.2003 | 428-D-2D

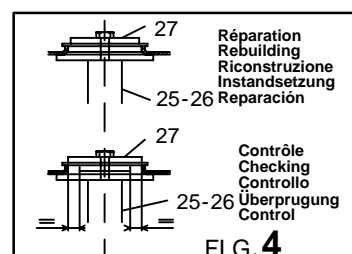
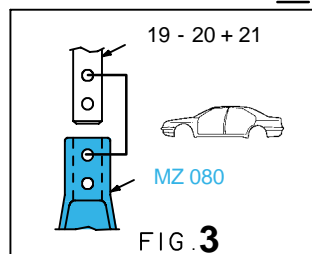
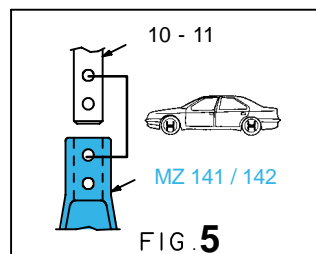
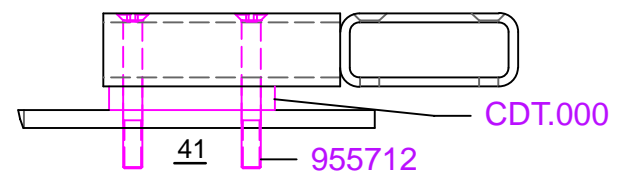
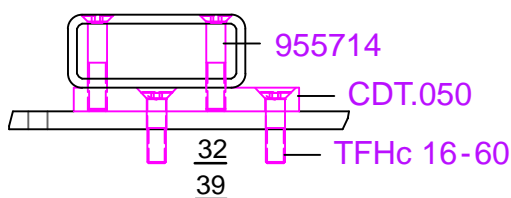
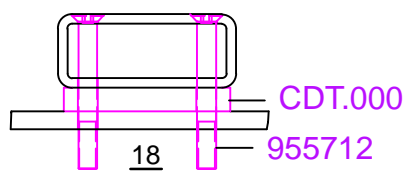
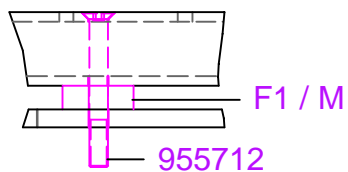
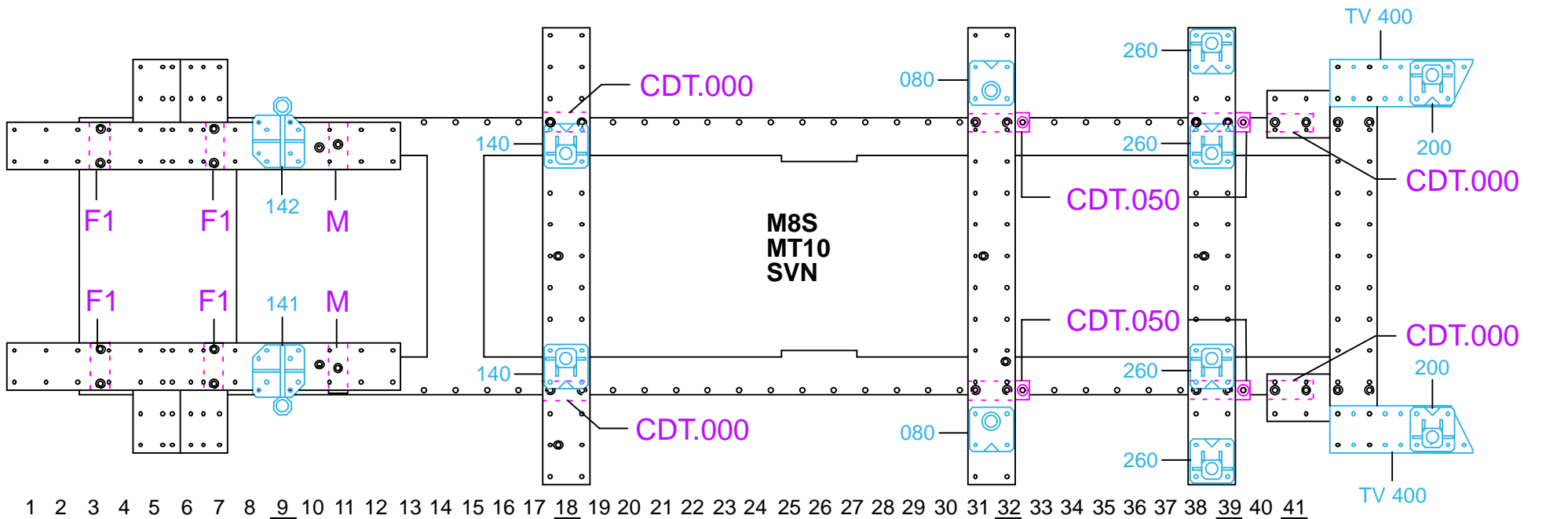

791.309-RVA3-1 | 00