

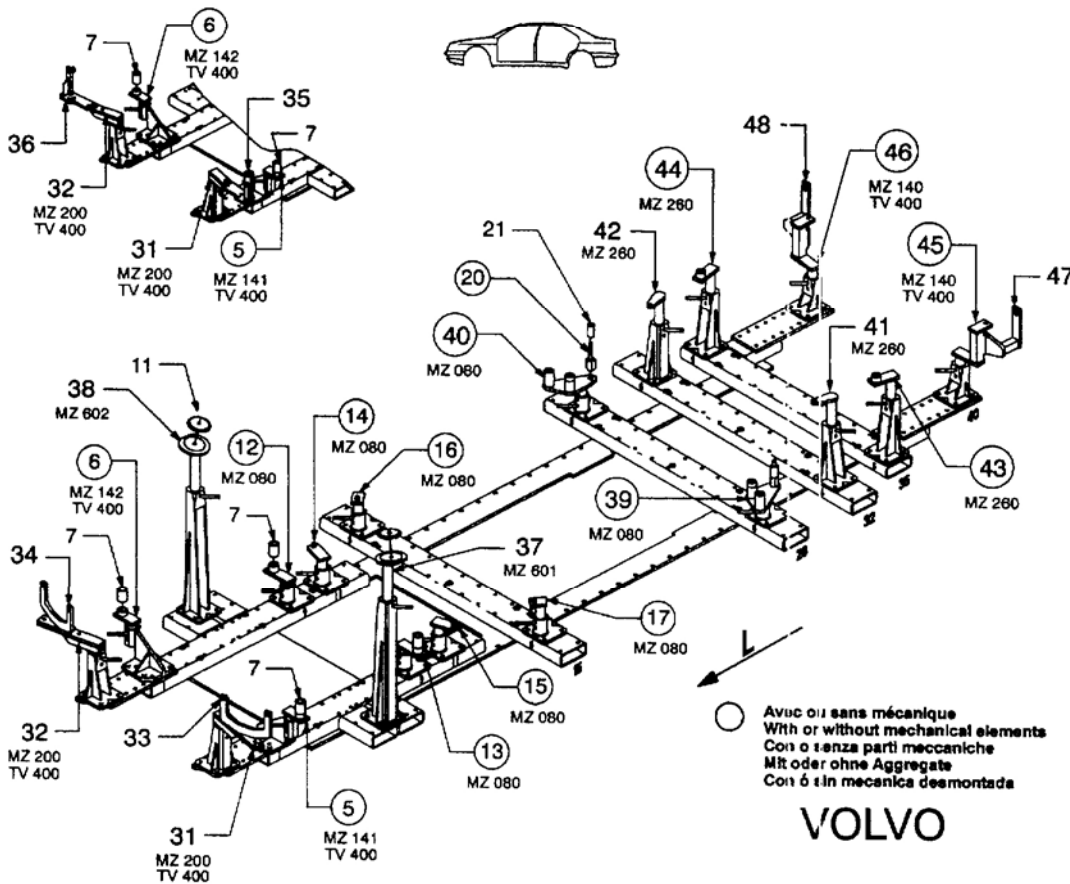

CELETTE®

VOLVO

" P26 " V70 Station Wagon V70 AWD Station Wagon



REP	REFERENCE	PDS	NB	MZ
31	784.7031	3,1	1	200
32	784.7032	3,1	1	200
33	784.7033	2,5	1	
34	784.7034	2,5	1	
35	784.7035	2,4	1	
36	784.7036	2,4	1	
37	784.7037	3,8	1	601
38	784.7038	3,6	1	602
39	784.7039	4,0	1	080
40	784.7040	4,0	1	080
41	784.7041	2,4	1	260
42	784.7042	2,4	1	260
43	784.7043	2,4	1	260/140
44	784.7044	2,4	1	260/140
45	784.7045	3,3	1	140
46	784.7046	3,3	1	140
47	784.7047	2,2	1	
48	784.7048	2,2	1	

M 10-35	4
M 10-40	2
M 10-60	2
M 12-25	4
M 12-30	4
M 12-40	2
M 12-65	2
M 12-120	4

M 12	2
------	---

complément au
complementary set to
complemento al
zusatz zu

784.300

784.309

53 Kg 04.04.2000 439-D-10C

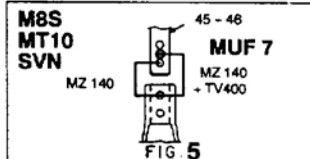
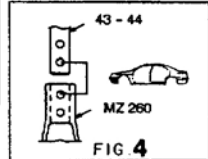
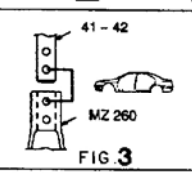
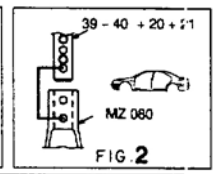
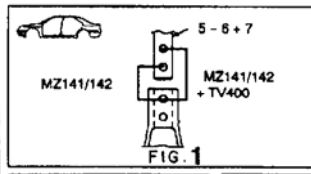
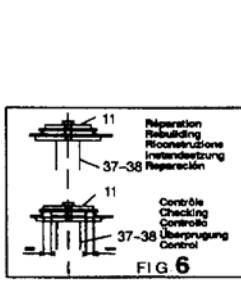
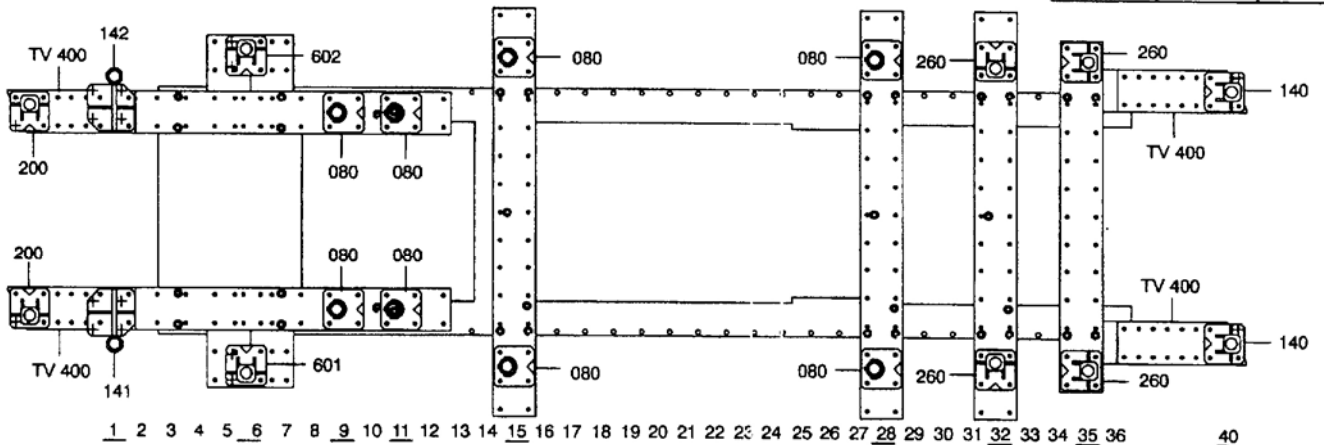

CELETTE®
VIENNE-FRANCE

© Copyright 2000 CELETTE S.A. - All rights reserved. No part of this document may be reproduced in any form, by photostat, xerography or any other means, or incorporated into any informational retrieval system electronic or mechanical, without the permission of the copyright owner.

