

REP.	REFERENCE	PDS	NB	MZ
1	781.7001	3,5	1	080
2	781.7002	3,5	1	080
3	781.7003	2,5	1	141
4	781.7004	2,5	1	142
5	781.7005	2,2	1	601
6	781.7006	2,2	1	602
7	781.7007	1,0	2	
8	781.7008	1,9	1	260/080
9	781.7009	1,9	1	260/080
10	781.7010	0,6	2	
11	781.7011	2,1	1	140/080
12	781.7012	2,1	1	140/080
13	781.7013	1,5	1	080
14	781.7014	1,5	1	080
15	781.7015	1,9	1	140
16	781.7016	1,9	1	140
17	781.7017	2,8	1	260
18	781.7018	2,8	1	260
19	781.7019	2,9	1	601
20	781.7020	2,9	1	602
21	781.7021	0,2	2	
22	781.7022	2,8	1	200
23	781.7023	2,8	1	200
24	781.7024	0,03	2	
25	781.7025	2,2	1	260
26	781.7026	2,2	1	260
	V.32	0,1	2	

M 10-16	6
M 12-30	2
M 12x125-30	2
M 12x125-50	2
M 12x125-135	2
M 14-30	2
M 14x150-50	2
M 14x150-30	4
M 14x150-130	2

MU 12	2
-------	---

<h1>781.300</h1>		
57 Kg	18.03.98	434-D-57A

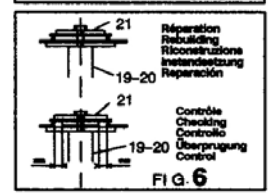
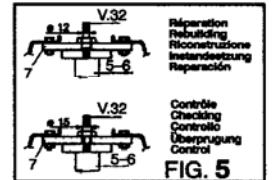
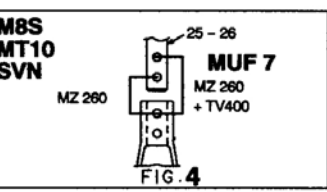
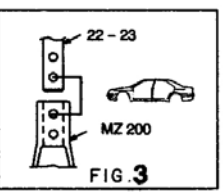
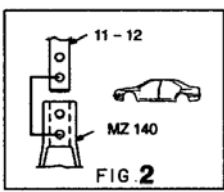
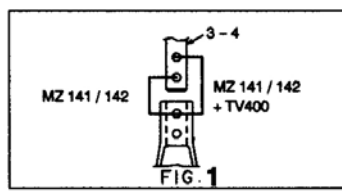
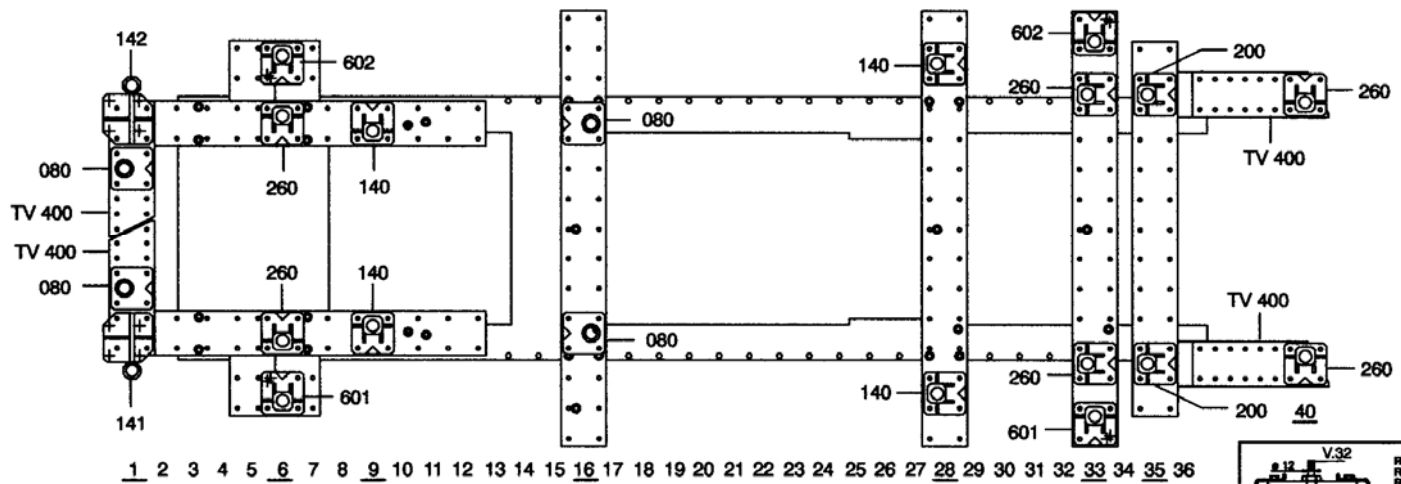

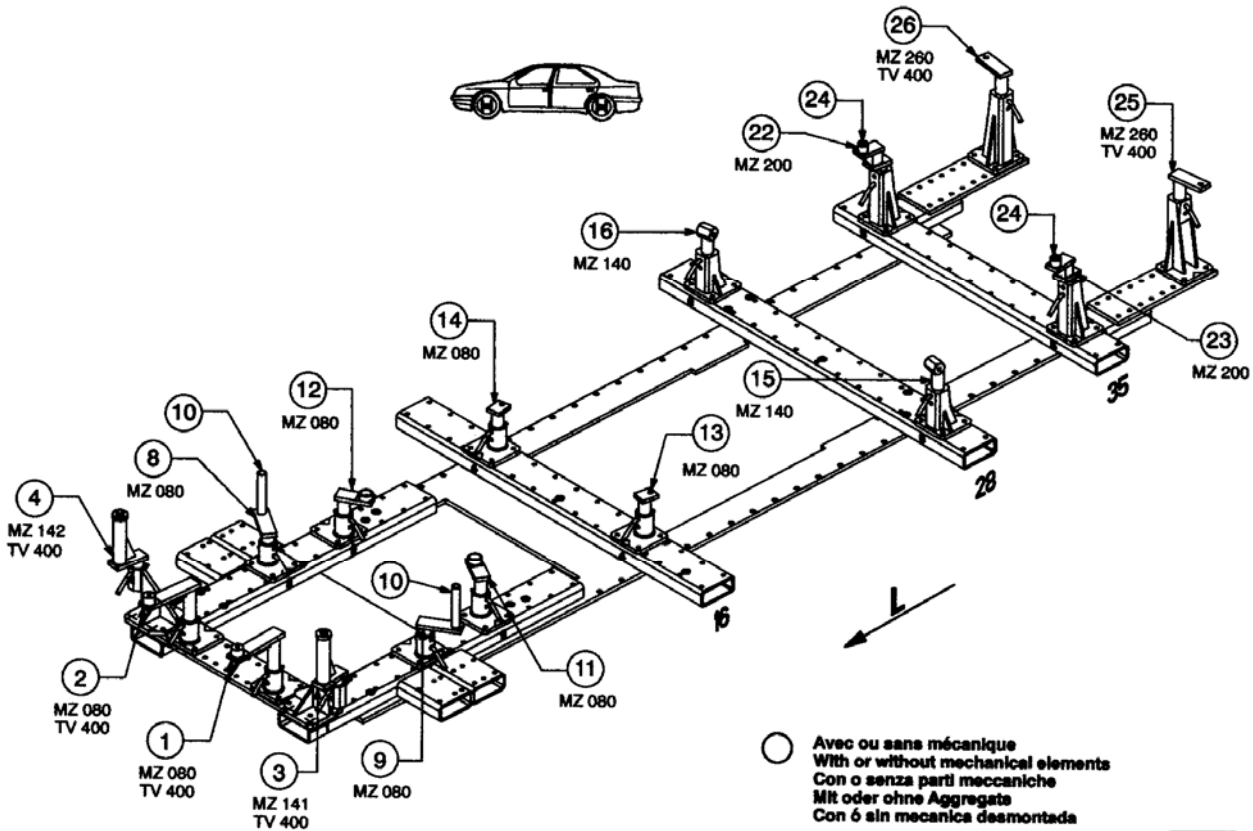

○ Avec ou sans mécanique
With or without mechanical elements
Con o senza parti meccaniche
Mit oder ohne Aggregate
Con ó sin mecánica desmontada

TOYOTA

781.300

57 Kg	18.03.96	434-D-57B
-------	----------	-----------

