

REP.	REFERENCE	PDS	NB	MZ
22	779.7022	2,7	1	200
23	779.7023	2,7	1	200
24	779.7024	1,8	1	200
25	779.7025	1,8	1	200
26	779.7026	2,0	1	602
27	779.7027	2,0	1	601
28	779.7028	4,1	1	200
29	779.7029	4,1	1	200
30	779.7030	2,0	1	260
31	779.7031	2,0	1	260
	T.002	0,05	2	

M 12-20	2
M 12x125-30	6
M 12x125-45	2
LU 12	2

complément au
complementary set to
complemento al
zusatz zu

779.300

FIAT

779.309

26 Kg 08.06.98 411-D-17C

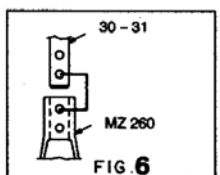
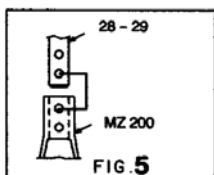
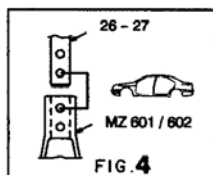
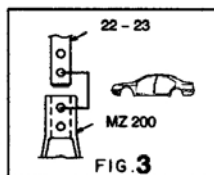
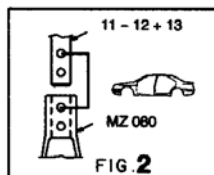
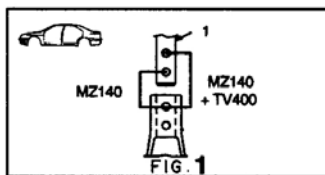
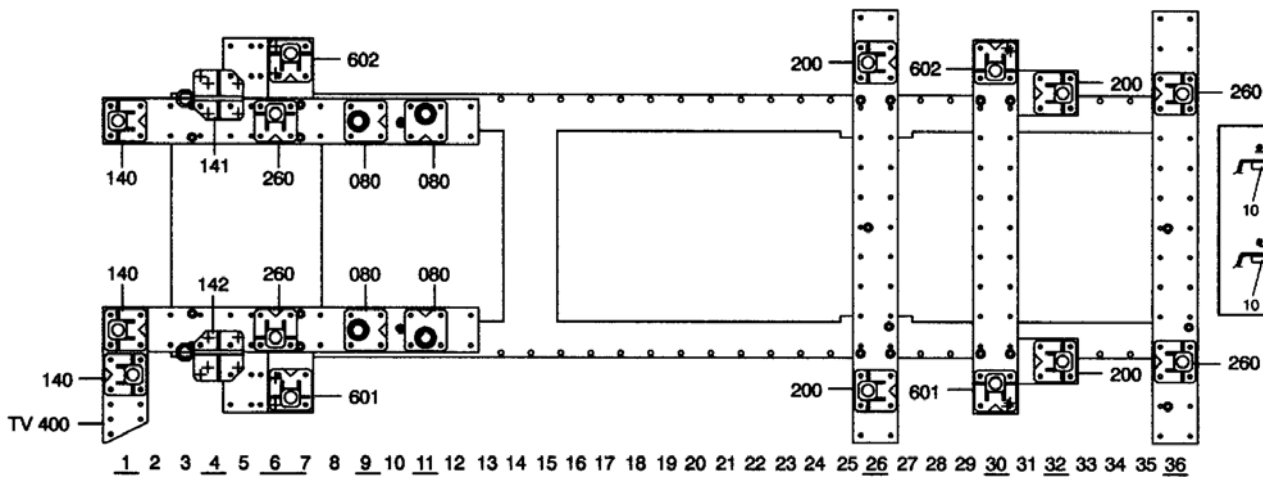

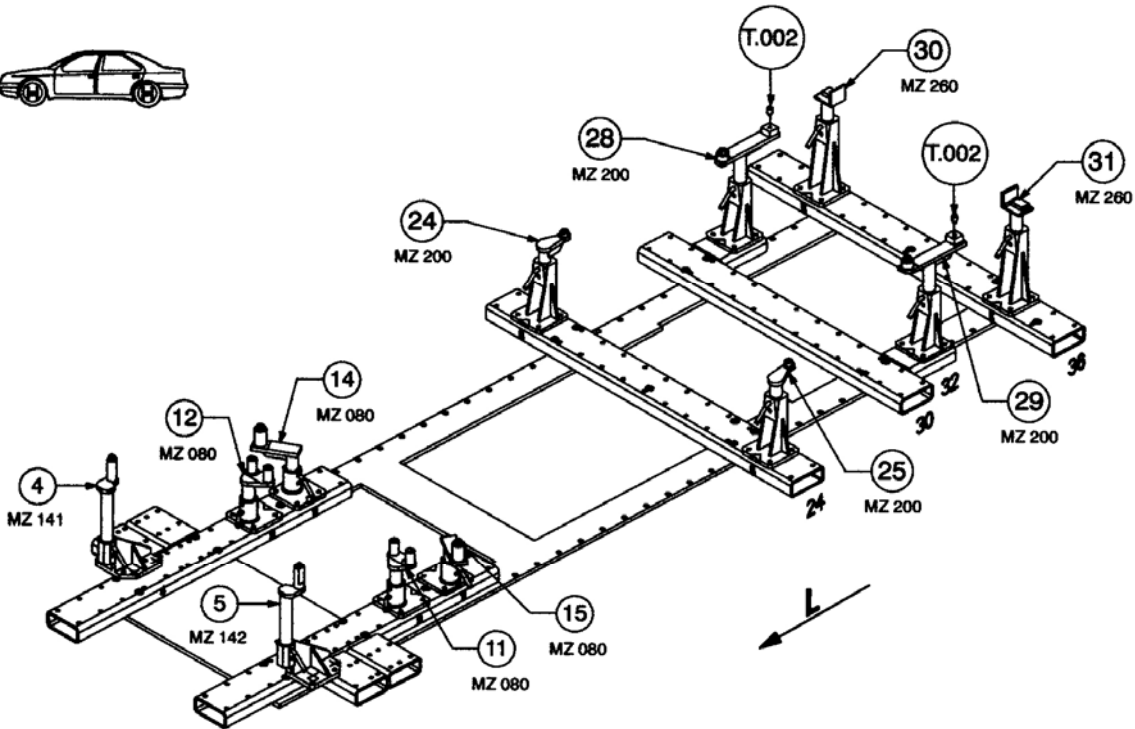

○ Avec ou sans mécanique
 With or without mechanical elements
 Con o senza parti meccaniche
 Mit oder ohne Aggregate
 Con ó sin mecánica desmontada

FIAT

779.309

28 Kg | 08.06.98 | 411-D-17D

