

○ Avec ou sans mécanique
 With or without mechanical elements
 Con o senza parti meccaniche
 Mit oder ohne Aggregate
 Con ó sin mecanica desmontada

REP.	REFERENCE	PDS	NB	MZ
33	779.7033	2,2	1	140
34	779.7034	2,2	1	140
35	779.7035	3,0	1	140
36	779.7036	2,2	1	080
37	779.7037	2,2	1	080
38	779.7038	0,3	2	
39	779.7039	2,5	1	080
40	779.7040	2,5	1	080
41	779.7041	1,0	2	
42	779.7042	3,1	1	140
43	779.7043	3,1	1	140
44	779.7044	1,6	1	
45	779.7045	1,6	1	
	E07	0,1	2	
	V48	0,1	2	

M 8-40	2
M 12-20	2
M 12-25	2
M 12-30	4
M 12-110	2
M 10x1,25-30	2
M 12x1,25-80	2
M 12x1,25-90	2

complément au
 complementary set to
 complemento al
 zusatz zu **779.300**

779.308

30 Kg 10.01.2001 411-D-17E

FIAT

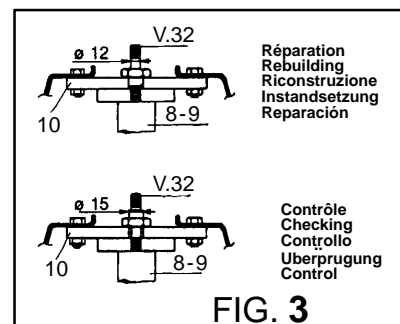
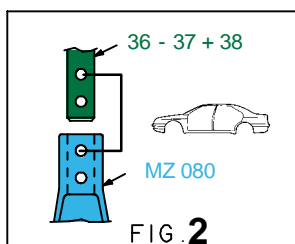
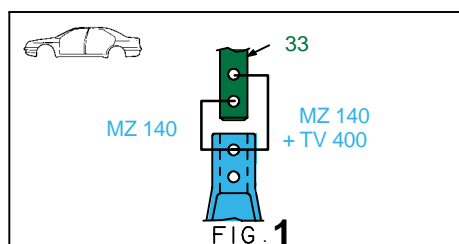
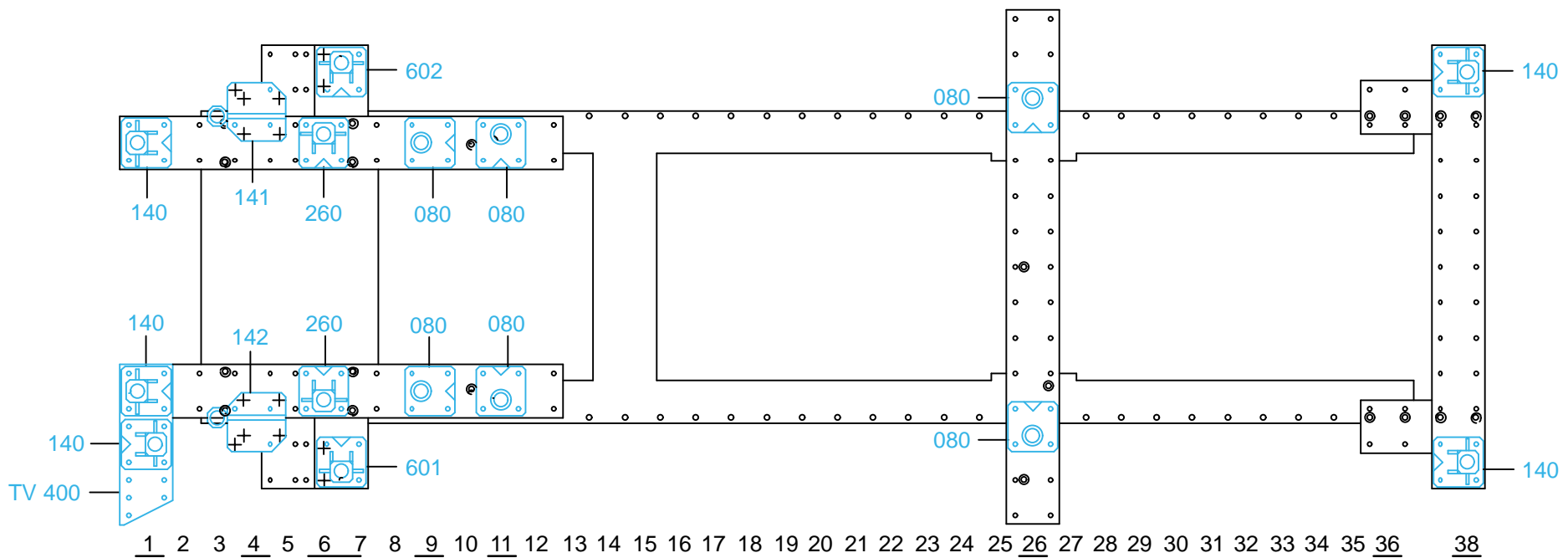

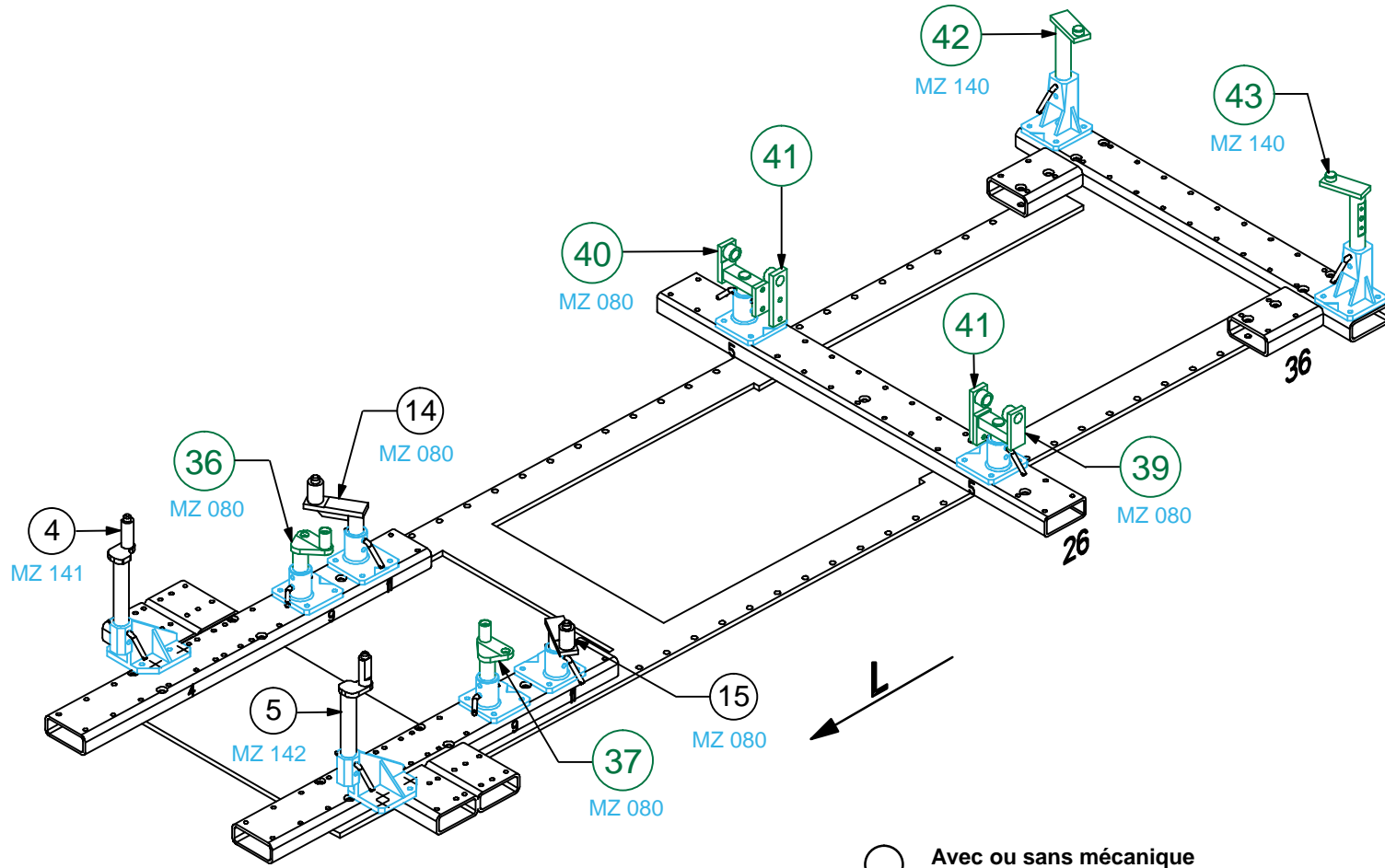
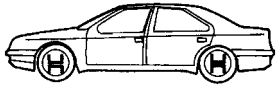

○ Avec ou sans mécanique
 With or without mechanical elements
 Con o senza parti meccaniche
 Mit oder ohne Aggregate
 Con ó sin mecanica desmontada

FIAT

779.308

30 Kg | 10.01.2002 | 411-D-17F

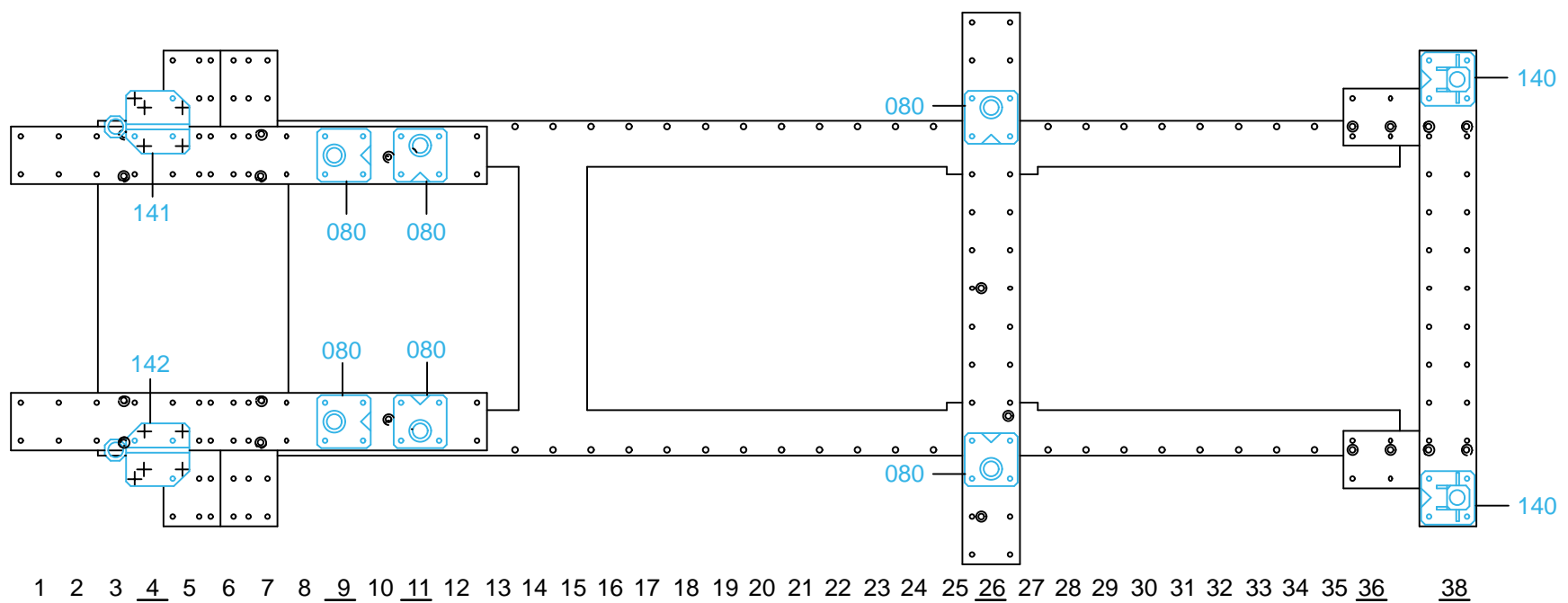

1 2 3 4 5 6 7 8 9 10 11 12 13 14 15 16 17 18 19 20 21 22 23 24 25 26 27 28 29 30 31 32 33 34 35 36 38

