

REP.	REFERENCE	PDS	NB	MZ
1	776.7001	2,0	1	140
3	776.7003	3,9	1	260
4	776.7004	3,2	1	141
5	776.7005	1,1	1	
6	776.7006	3,2	1	601
7	776.7007	1,8	1	601
8	776.7008	1,8	1	602
9	776.7009	1,3	2	
10	776.7010	1,9	1	260/080
11	776.7011	1,9	1	260/080
12	776.7012	0,9	2	
13	776.7013	0,1	2	
14	776.7014	2,9	1	140/080
15	776.7015	2,9	1	140/080
16	776.7016	2,7	1	080
17	776.7017	2,7	1	080
18	776.7018	2,5	1	140
19	776.7019	2,5	1	140
20	776.7020	3,3	1	601/602
23	776.7023	0,3	2	
24	776.7024	3,0	1	200
25	776.7025	3,0	1	200
30	776.7030	1,0	1	
32	776.7032	2,6	1	200
33	776.7033	2,6	1	200
86	776.7086	1,8	1	140
87	776.7087	2,4	1	260
88	776.7088	2,4	1	260
V20		0,05	1	
V32		0,1	2	
V60		0,1	2	
V75		0,1	1	

	M 8-20	6
	M 8-25	4
	M 12-30	2
	M 12-80	2
	M 12-130	2
	M 12x1,50-80	4
	M 12x1,50-150	4
	CHc 8-20	2
	M 8	1
	M 12	2

○ Avec ou sans mécanique
 With or without mechanical elements
 Con o senza parti meccaniche
 Mit oder ohne Aggregate
 Con ó sin mecanica desmontada

PEUGEOT

776.320

66 Kg 20.12.2005 423-D-18N

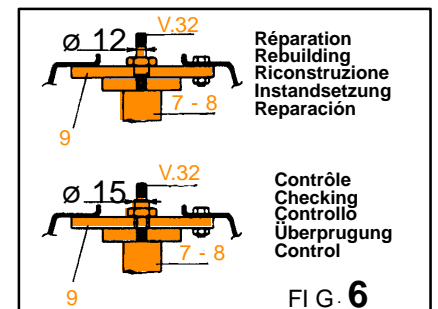
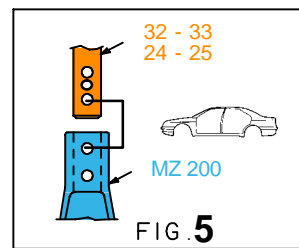
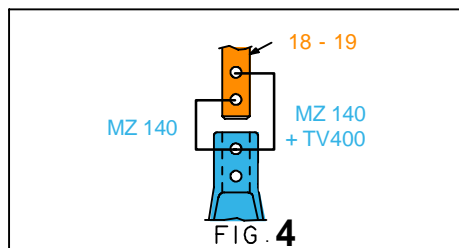
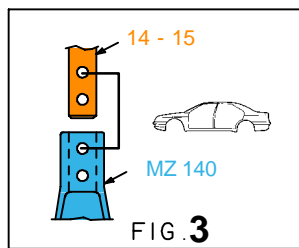
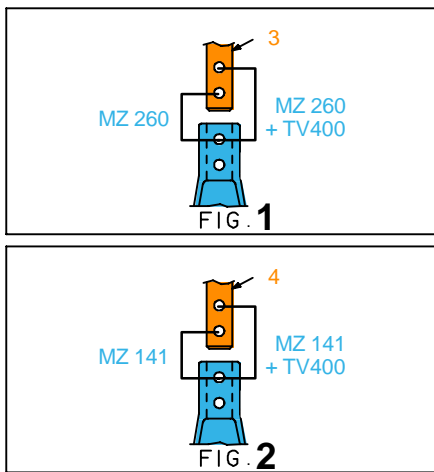
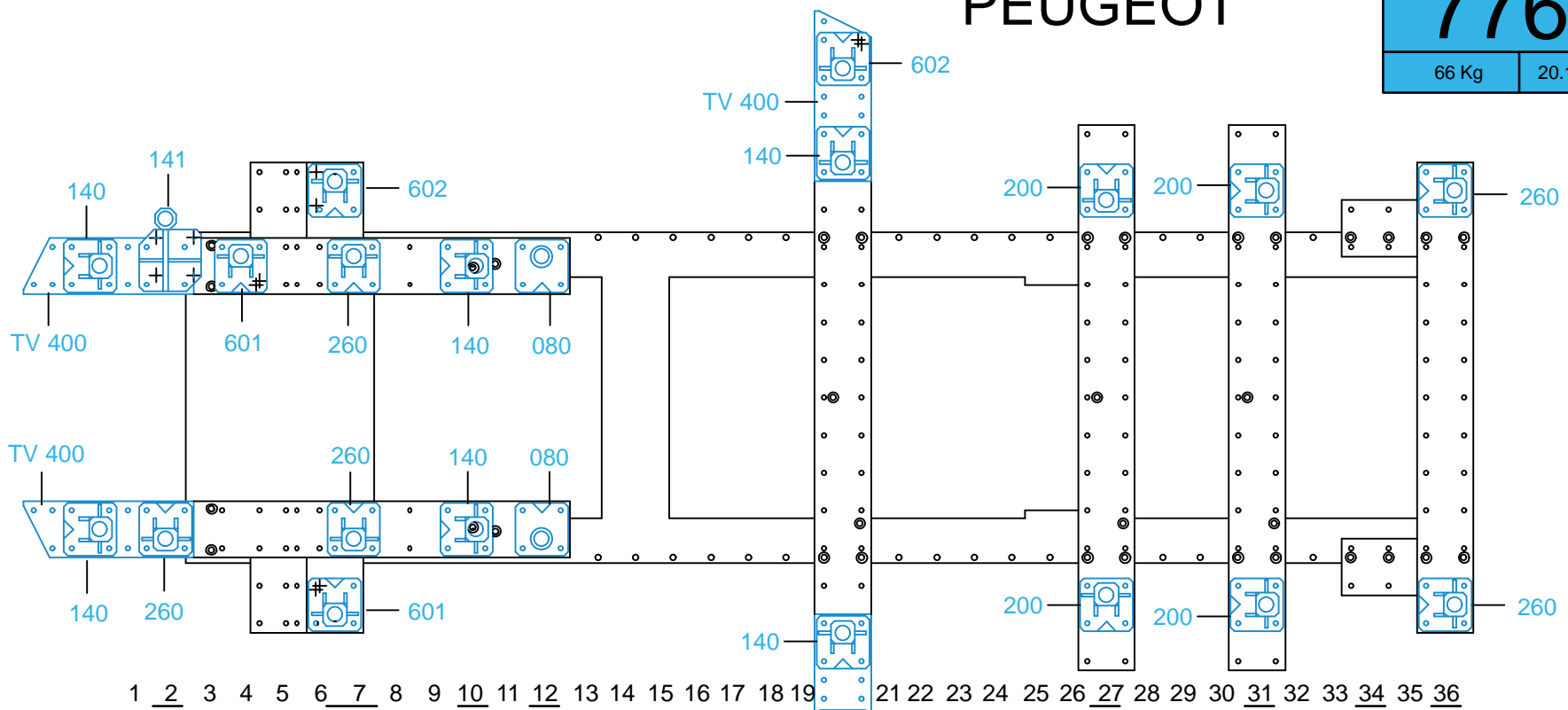

776.320-RVA3-1 00

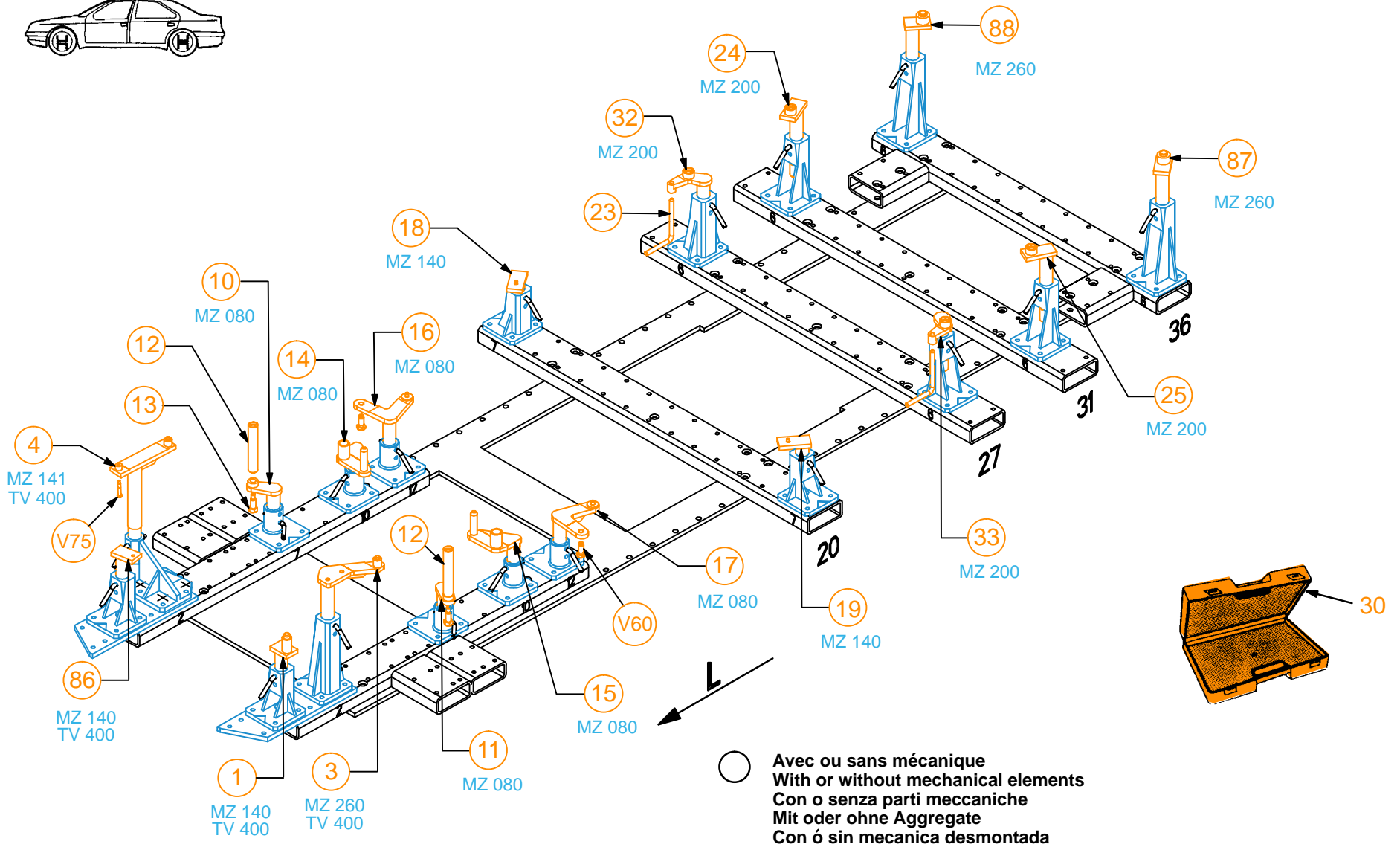
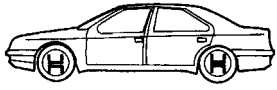

PEUGEOT

776.320

66 Kg 20.12.2005 423-D-18P

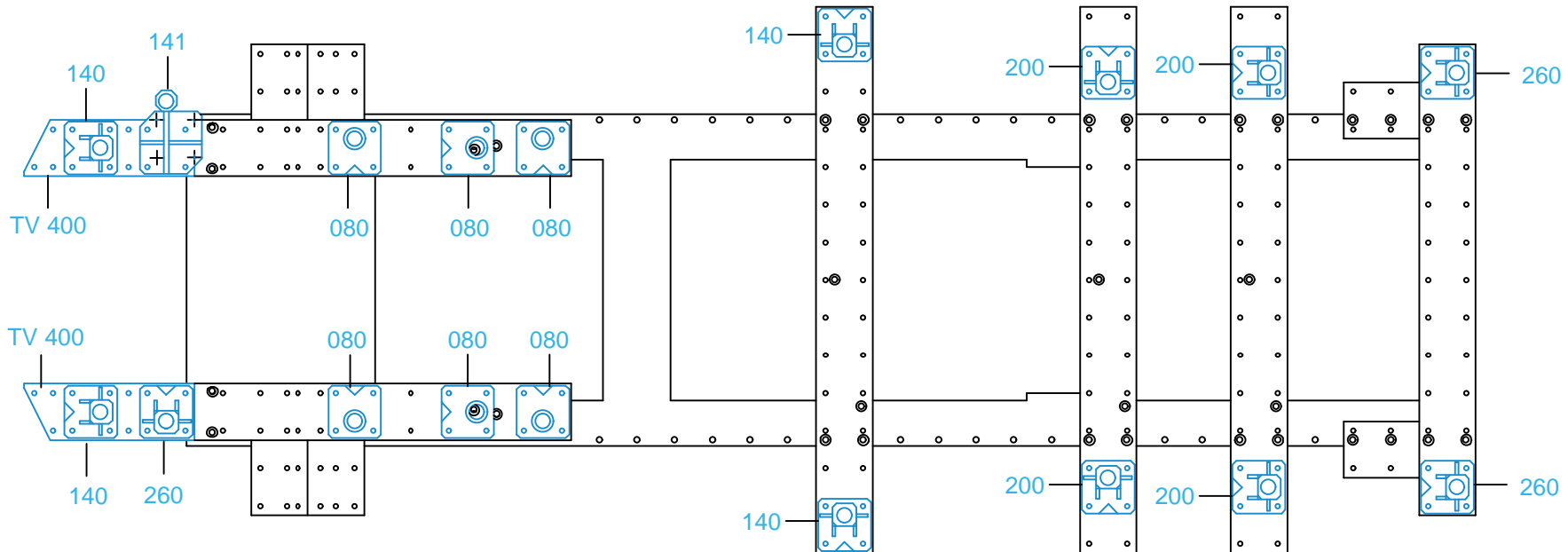

1 2 3 4 5 6 7 8 9 10 11 12 13 14 15 16 17 18 19 20 21 22 23 24 25 26 27 28 29 30 31 32 33 34 35 36

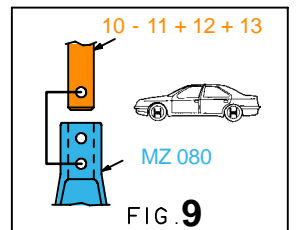
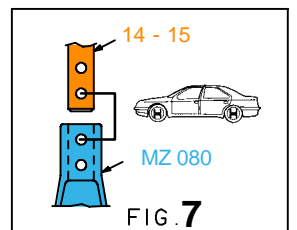
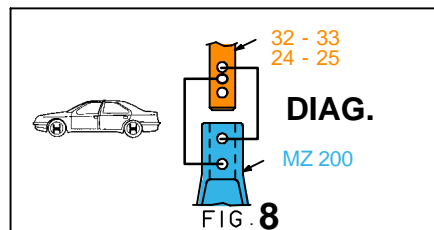
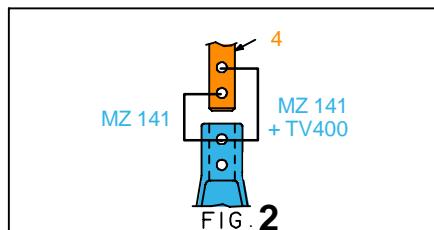
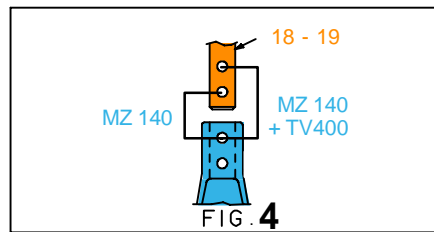
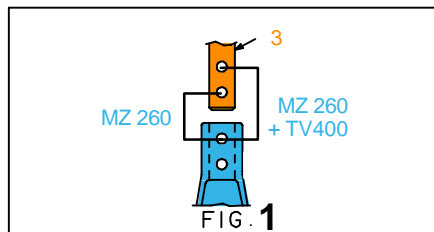
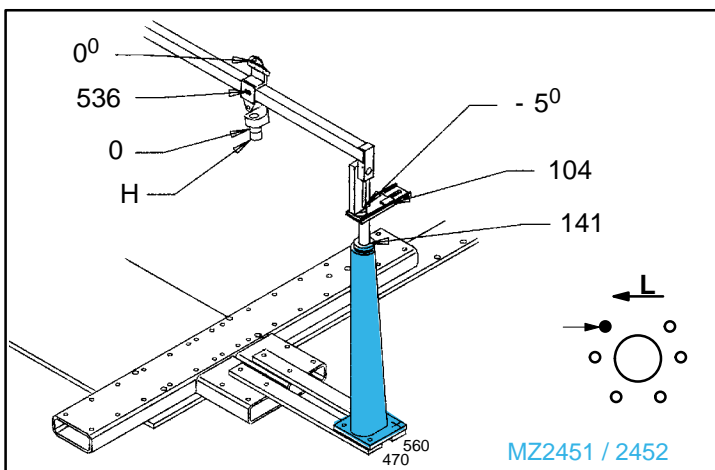

776.320-RVA3-1 | 00