

○ Avec ou sans mécanique
 With or without mechanical elements
 Con o senza parti meccaniche
 Mit oder ohne Aggregate
 Con ó sin mecanica desmontada

REP.	REFERENCE	PDS	NB	MZ
1	742.7001	2,1	1	142
2	742.7002	2,1	1	141
3	742.7003	2,2	1	601
4	742.7004	2,2	1	602
5	742.7005	1,7	1	080/260
6	742.7006	1,7	1	080/260
7	742.7007	1,2	2	
8	742.7008	0,3	2	
9	742.7009	1,8	1	080/140
10	742.7010	1,8	1	080/140
11	742.7011	1,5	1	080
12	742.7012	1,5	1	080
13	742.7013	2,8	1	140
14	742.7014	2,8	1	140
15	742.7015	0,2	2	
16	742.7016	2,4	1	260
17	742.7017	2,4	1	260
18	742.7018	0,4	2	
19	742.7019	1,4	1	200
20	742.7020	1,4	1	200
	D.090	0,6	2	
	V.32	0,1	2	

	M 10x25	4
	M 12x20	2
	M 12x30	2
	M 12x100	4
	M 12.125x110	6
	M 12.125x140	2
	M 12.125x150	2
	M 12.125x180	2

	M 10	4
--	------	---

ROVER

742.300

38 Kg 14.06.96 404-D-15A

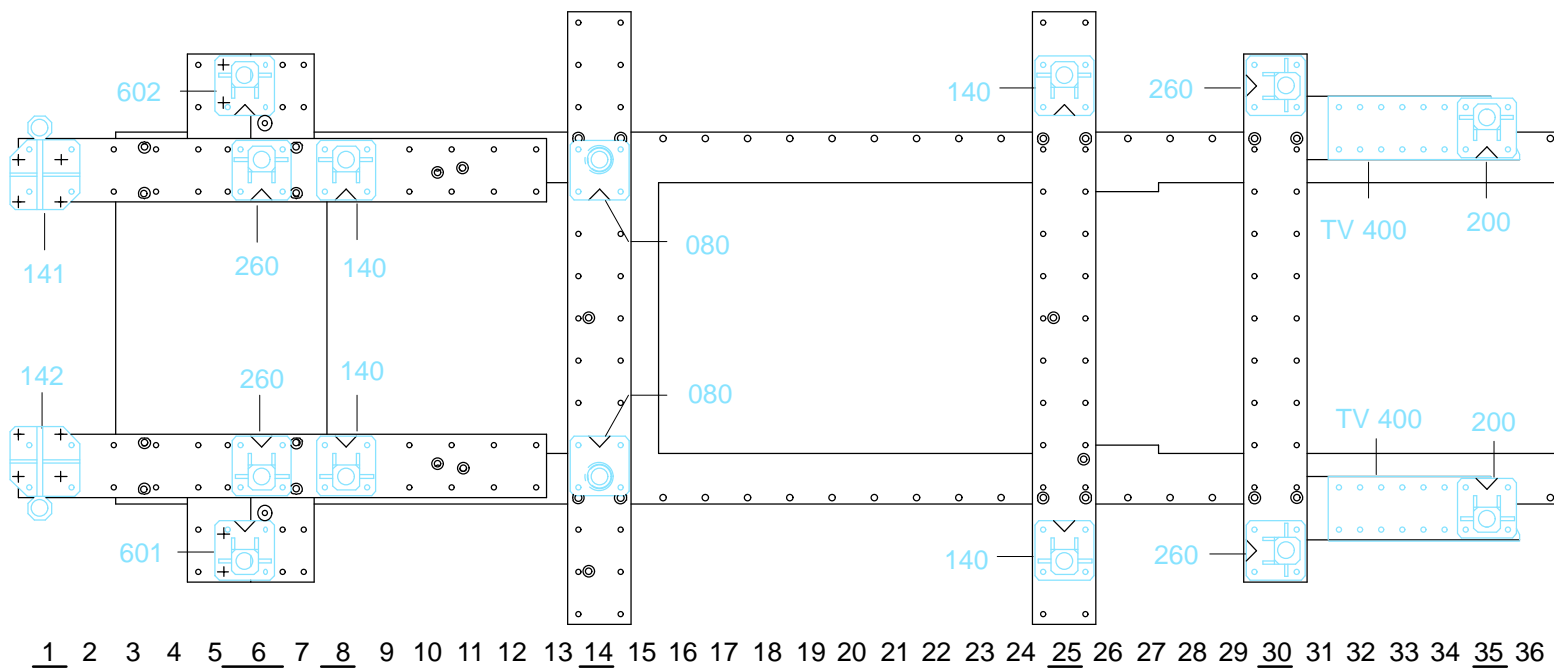

1 2 3 4 5 6 7 8 9 10 11 12 13 14 15 16 17 18 19 20 21 22 23 24 25 26 27 28 29 30 31 32 33 34 35 36

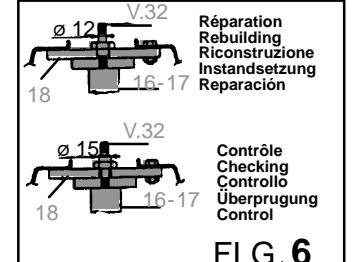
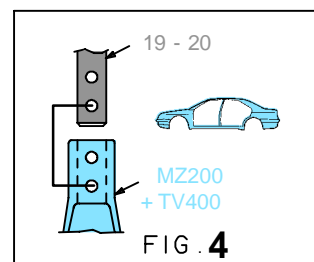
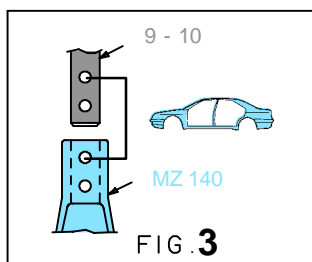
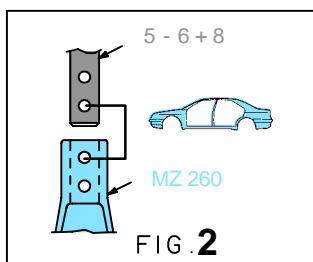
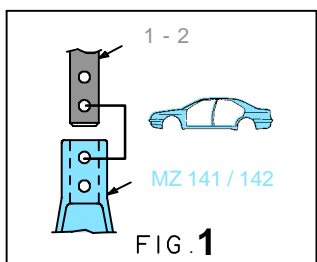
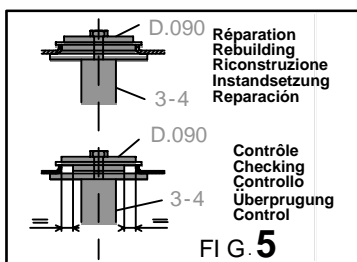

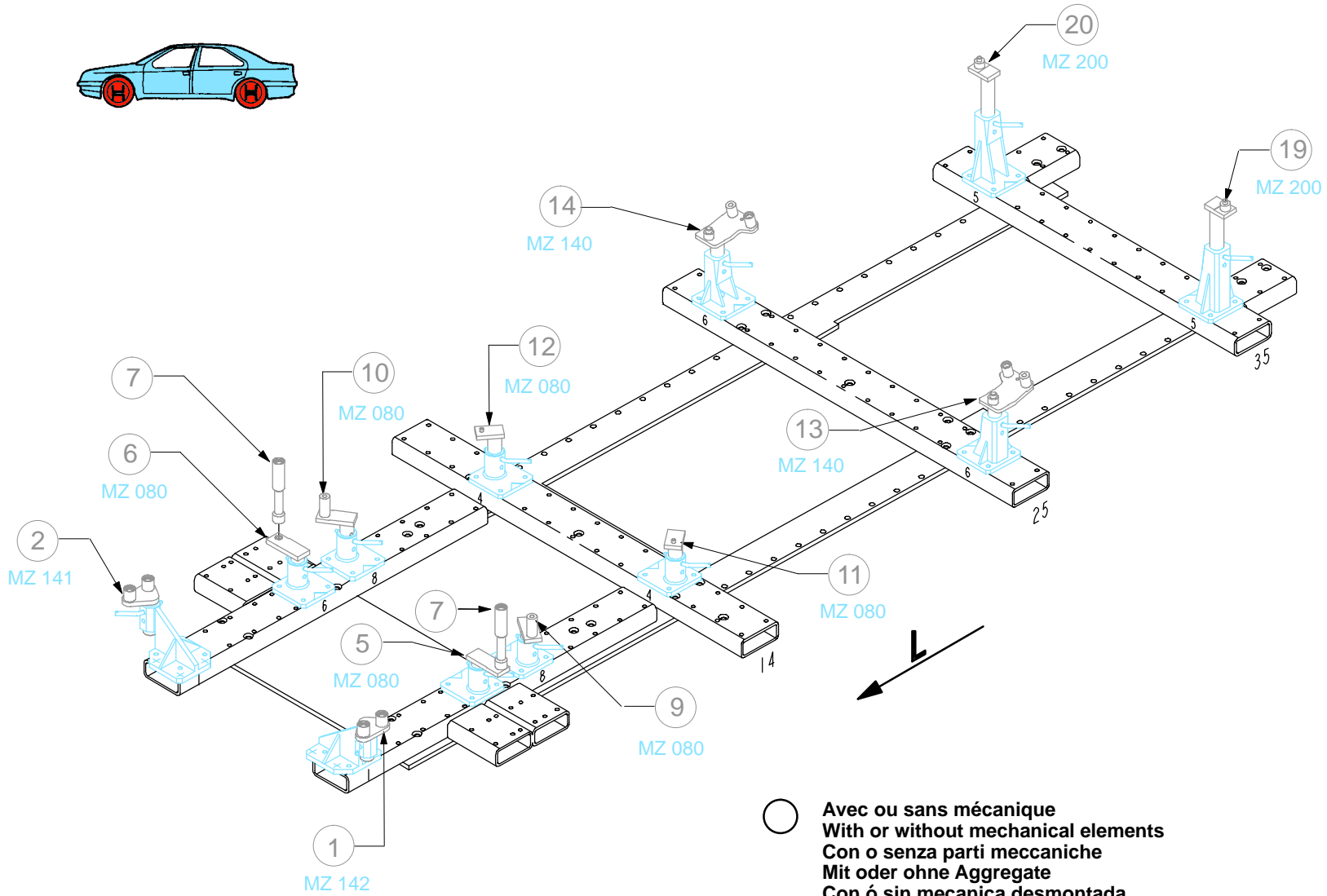
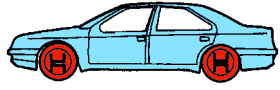

○ Avec ou sans mécanique
 With or without mechanical elements
 Con o senza parti meccaniche
 Mit oder ohne Aggregate
 Con ó sin mecanica desmontada

ROVER

742.300

38 Kg | 14.06.96 | 404-D-15B

