

TYP.	MOD.
JEOE	T072410 →
	K009200 →
	T072301 →
JE0H	T011847 →
	K001683 →
	T011812 →
JE0P	T027517 →
	K015073 →
	T027325 →
JEOA	T051787 →
	T051769 →
JE0N	T025648 →
	T025462 →
JEOG	T008652 →
	T008559 →
JE0M	T002512 →
	K000001 →
	T002440 →
JE0L	T000001 →
	T000001 →
JE0K	T000001 →
	K000001 →
JE0S	T000001 →
	K000001 →

REP.	REFERENCE	PDS	NB	MZ
42	741.7042	1,0	1	
43	741.7043	3,4	1	260

● M 12-45 2
 complément au
 complementary set to
 complemento al
 zusatz zu
741.300
675.308
741.309

RENAULT

741.307

5 Kg	05.09.2000	427-D-24H
------	------------	-----------

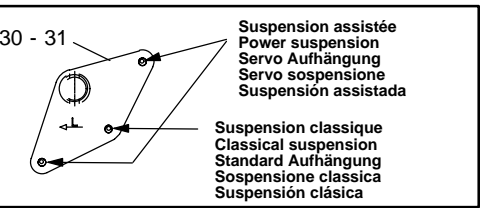
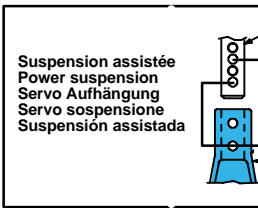
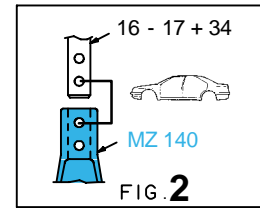
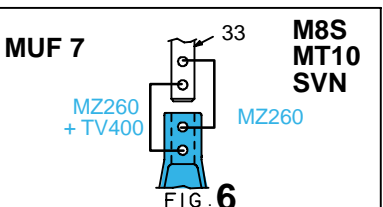
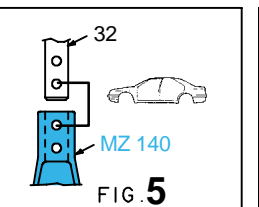
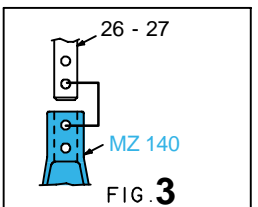
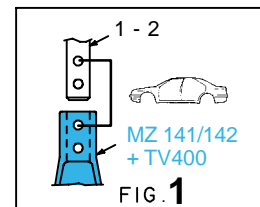
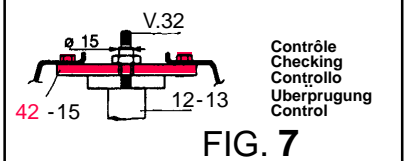
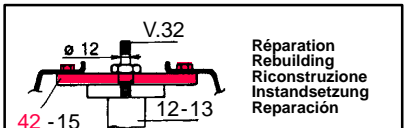
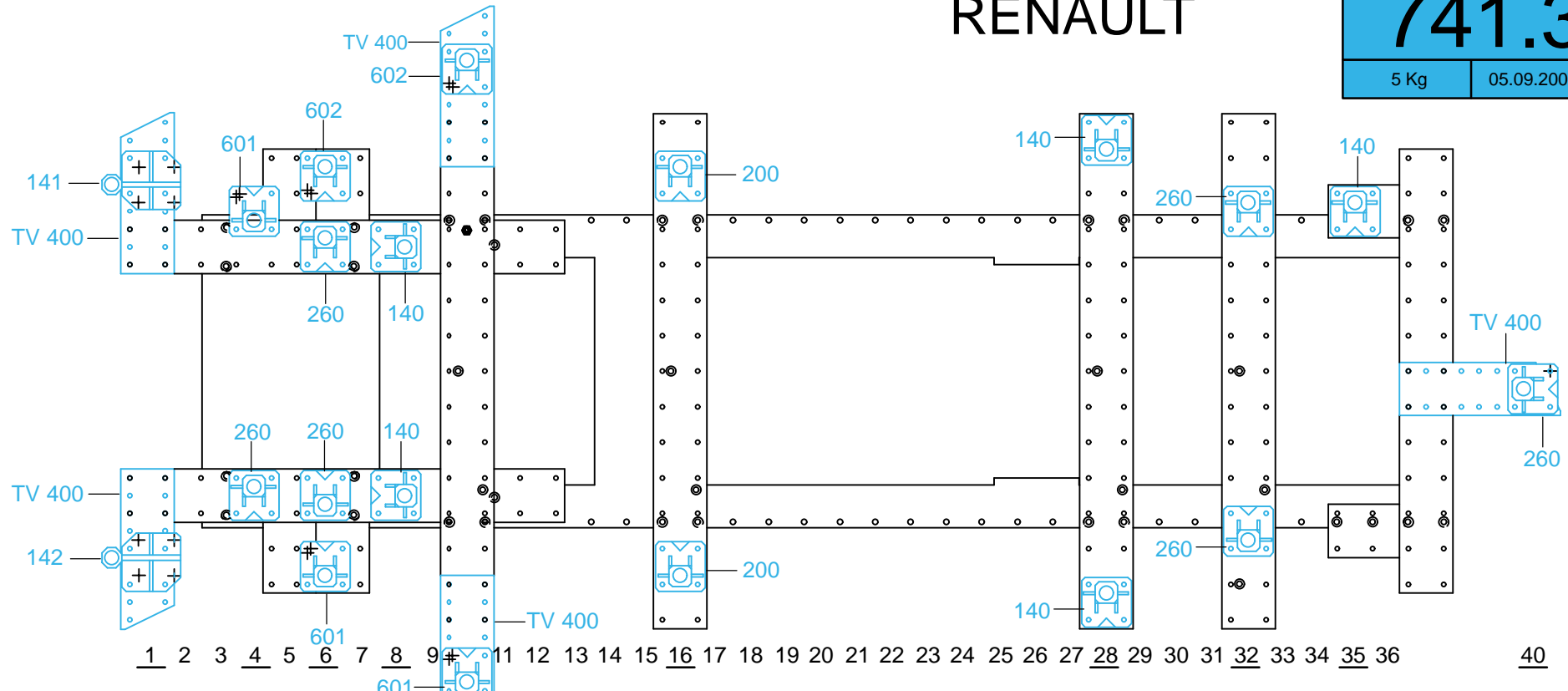

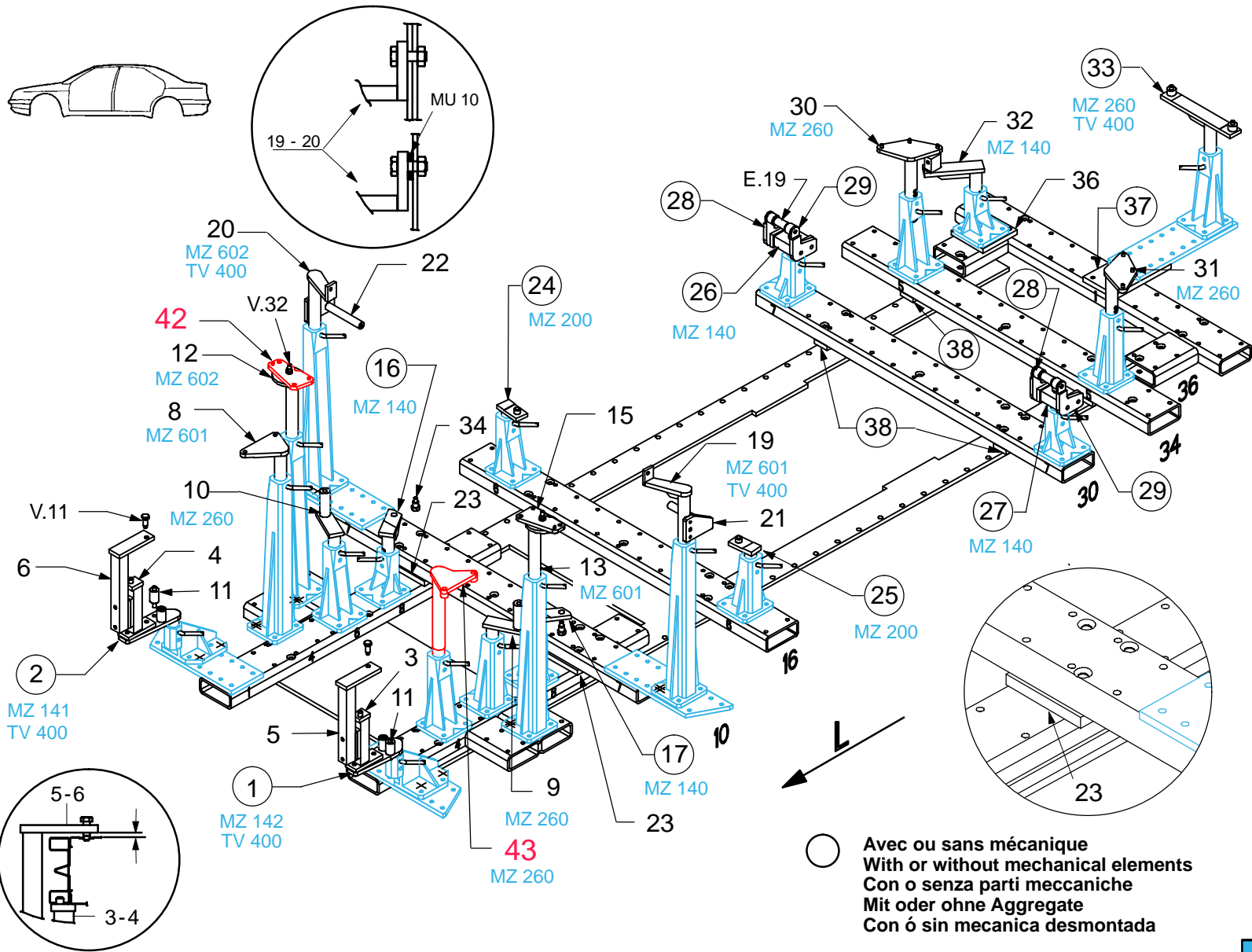

TYP.	MOD.
JEOE	T072410 → K009200 → T072301 →
JEOH	T011847 → K001683 → T011812 →
JEOP	T027517 → K015073 → T027325 →
JEOA	T051787 → T051769 →
JEON	T025648 → T025462 →
JEOG	T008652 → T008559 →
JEOM	T002512 → K000001 → T002440 →
JEOL	T000001 →
JEOK	T000001 → K000001 →
JEOS	T000001 → K000001 →

○ Avec ou sans mécanique
With or without mechanical elements
Con o senza parti meccaniche
Mit oder ohne Aggregate
Con ó sin mecanica desmontada

RENAULT

741.307

5 Kg 05.09.2000 427-D-24K

