

REP.	REFERENCE	PDS	NB	MZ
23	740.7023	2,2	1	141
24	740.7024	2,2	1	142
25	740.7025	1,9	1	260
26	740.7026	1,9	1	260
27	740.7027	2,4	1	080
28	740.7028	2,4	1	080

M 14.150x40	2
M 14.150x120	2

complément au
complementary set to
complemento al
zusatz zu **740.300**

740.309

13 Kg	28.08.96	434-D-54C
-------	----------	-----------

TOYOTA

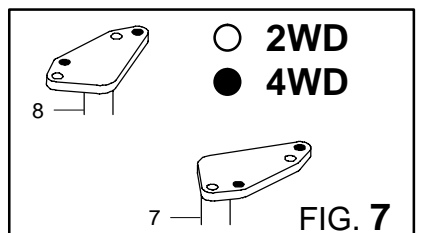
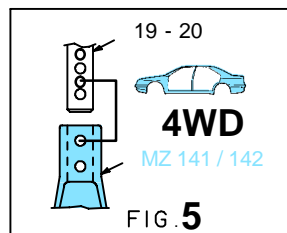
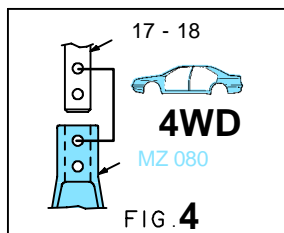
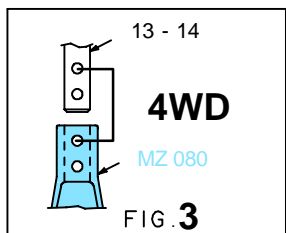
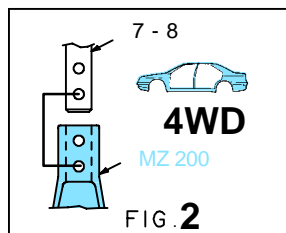
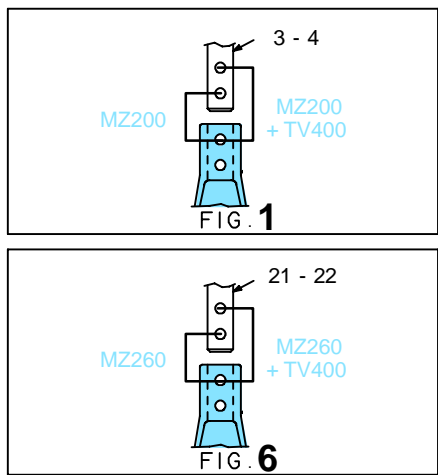
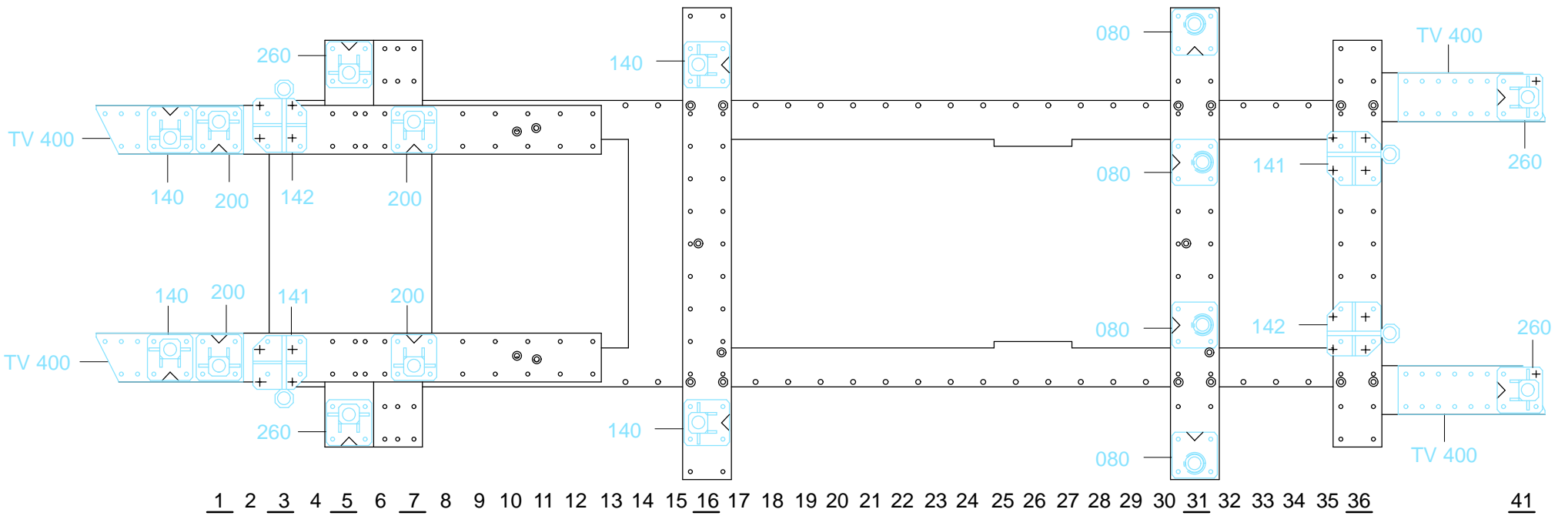

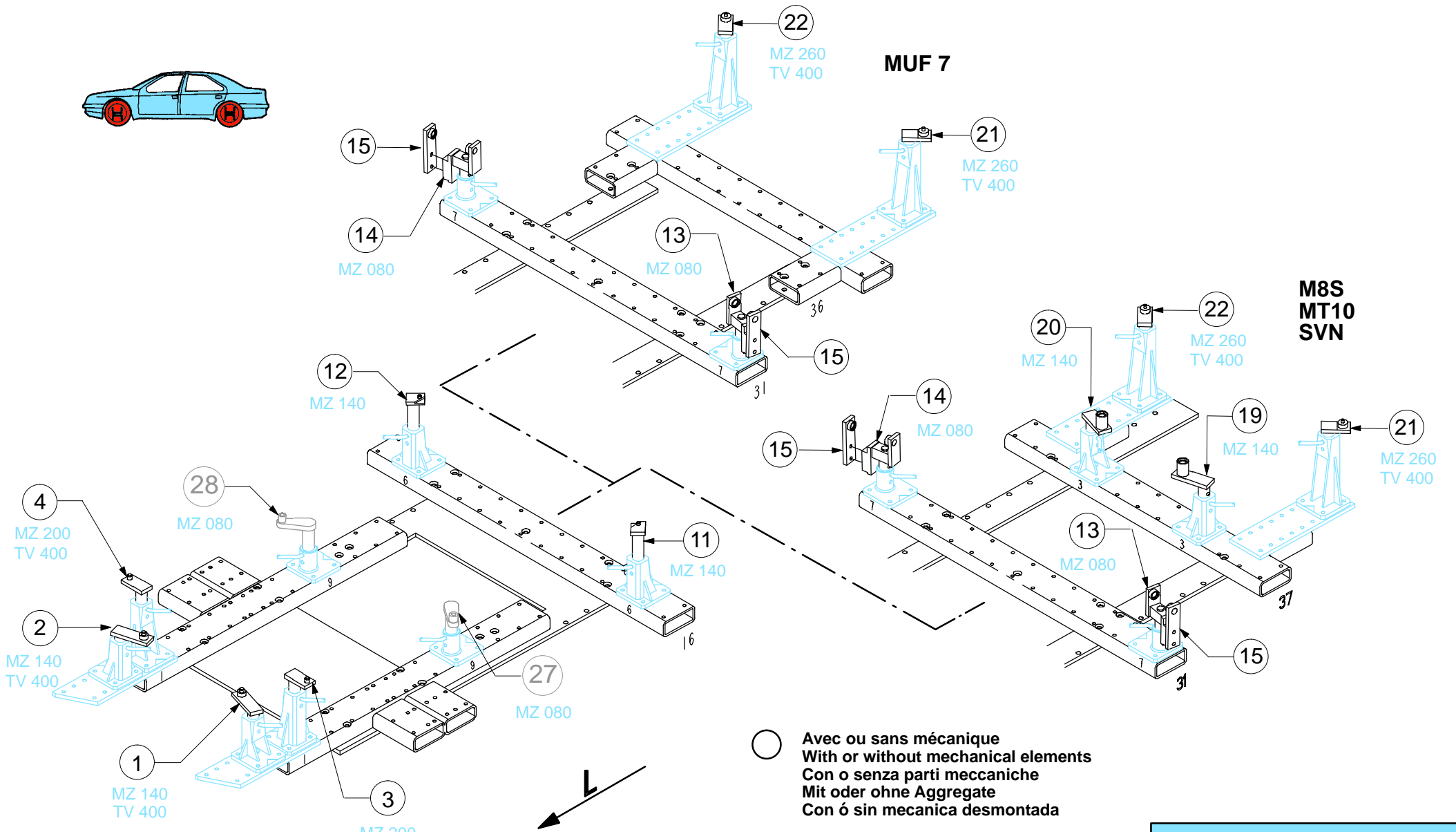

TOYOTA

740.309

13 Kg | 28.08.96 | 434-D-54D

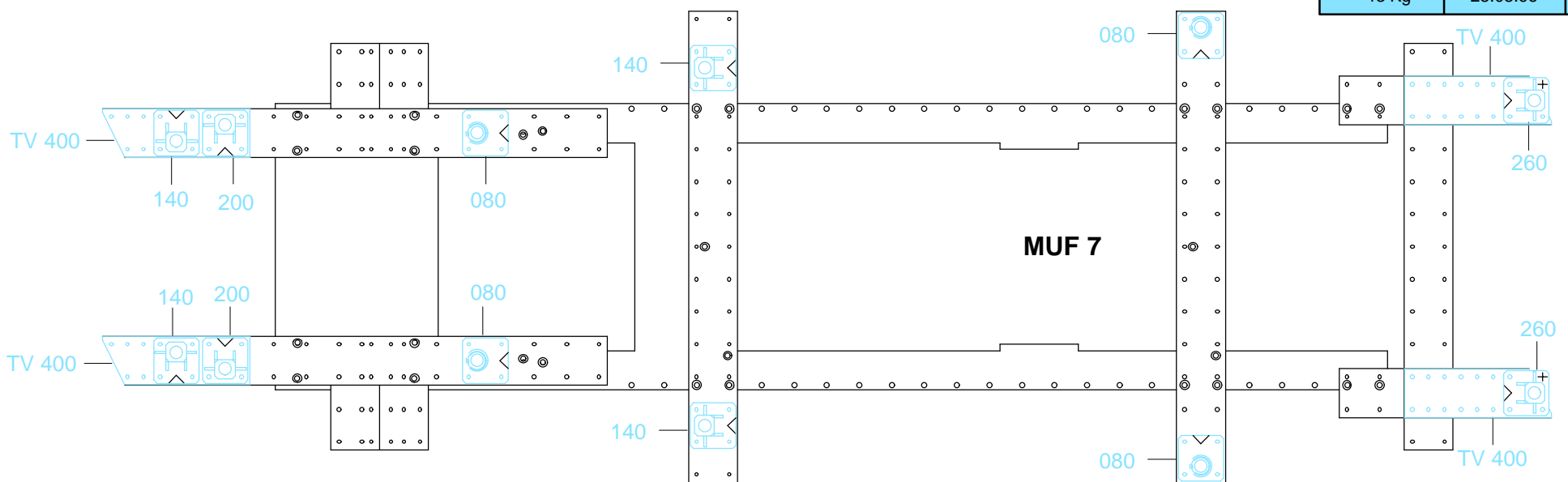

1 2 3 4 5 6 7 8 9 10 11 12 13 14 15 16 17 18 19 20 21 22 23 24 25 26 27 28 29 30 31 32 33 34 35 36

41

