

○ Avec ou sans mécanique  
 With or without mechanical elements  
 Con o senza parti meccaniche  
 Mit oder ohne Aggregate  
 Con ó sin mecanica desmontada

VAS 5020 / 6

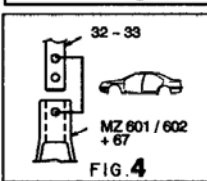

REP.	REFERENCE	PDS	NB	MZ
64	737.7064	3,2	1	
65	737.7065	3,2	1	
66	737.7066	3,0	2	
67	737.7067	2,3	4	
68	737.7068	0,1	12	
M 8-25 M 12-25			2	
TFHc 16-50			12	
M16			12	
complément au / complementary set to / complemento al / zusatz zu				<b>737.300</b>
<b>737.307</b>				
24 Kg	30.06.98	403-D-13A		

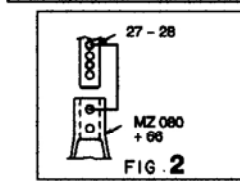
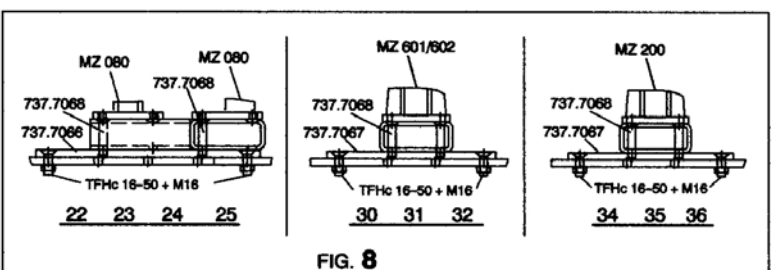
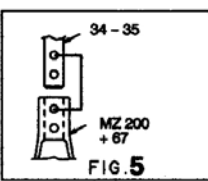
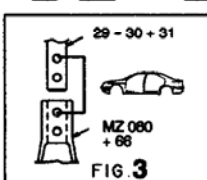
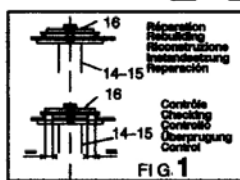
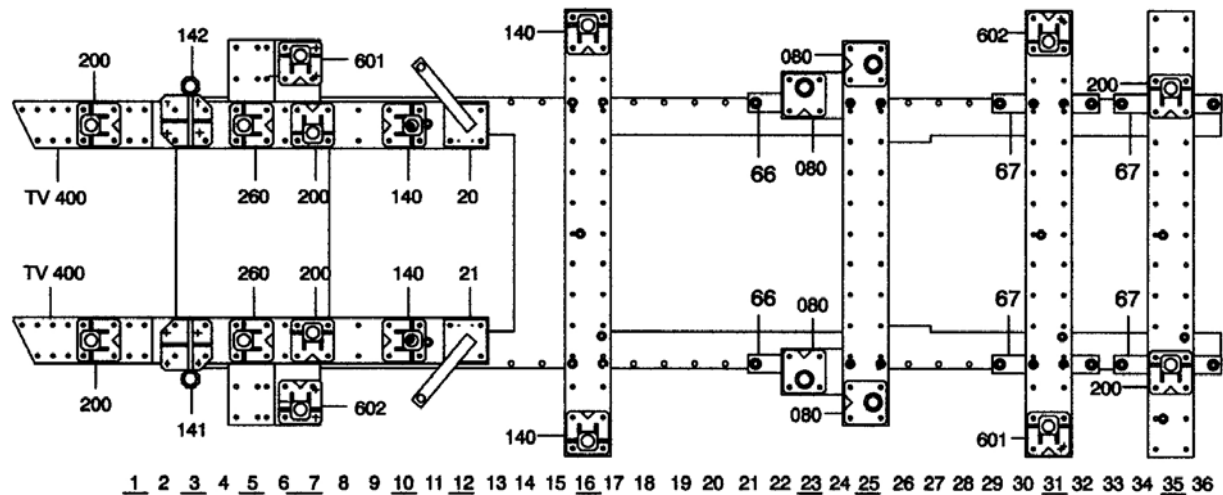

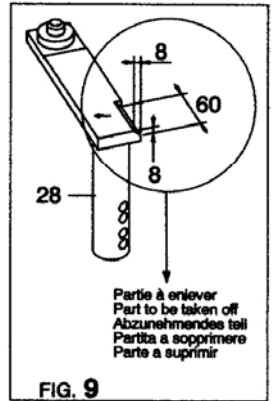
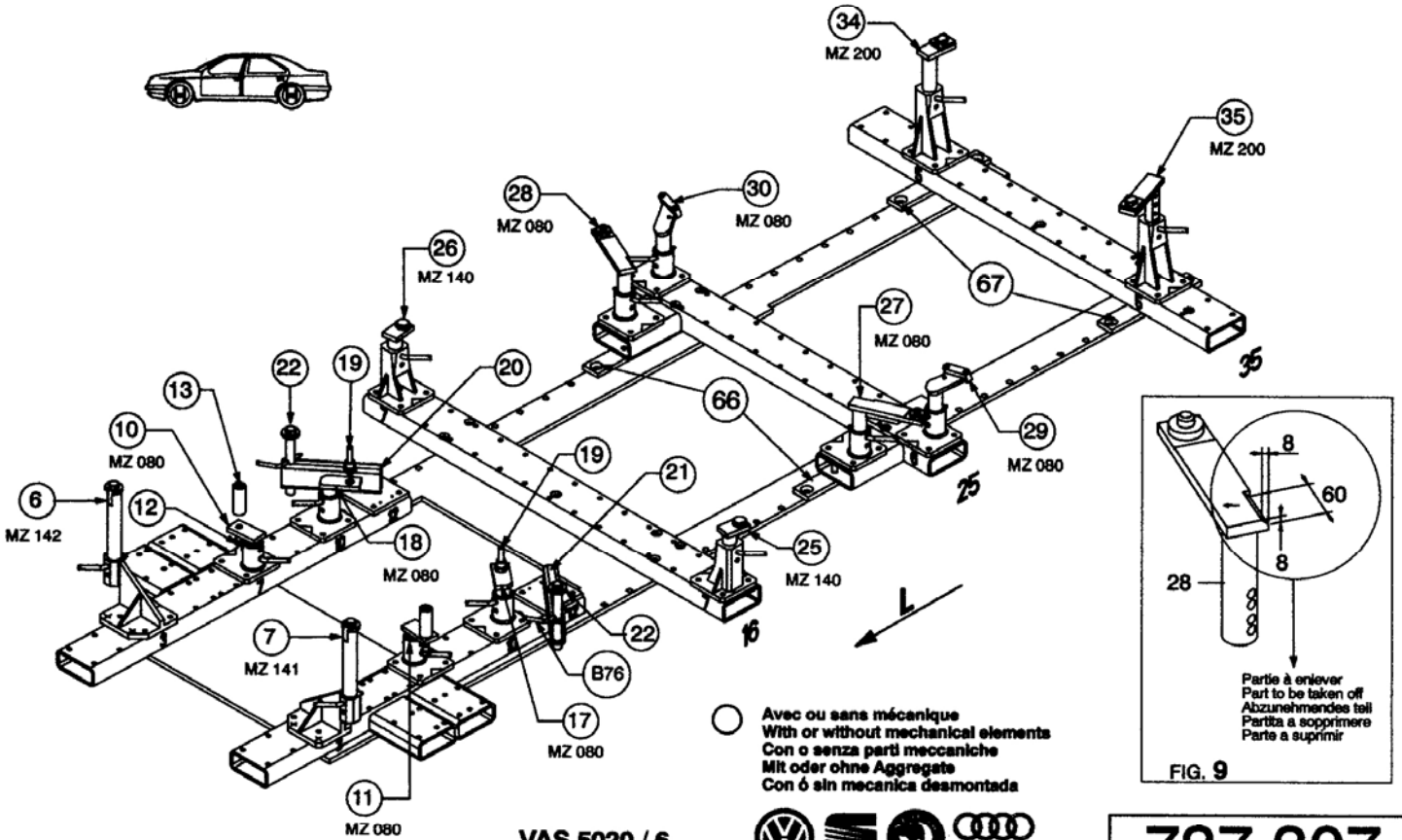

**VAS 5020 / 6**



**737.307**

24 Kg | 30.06.98 | 403-D-13B

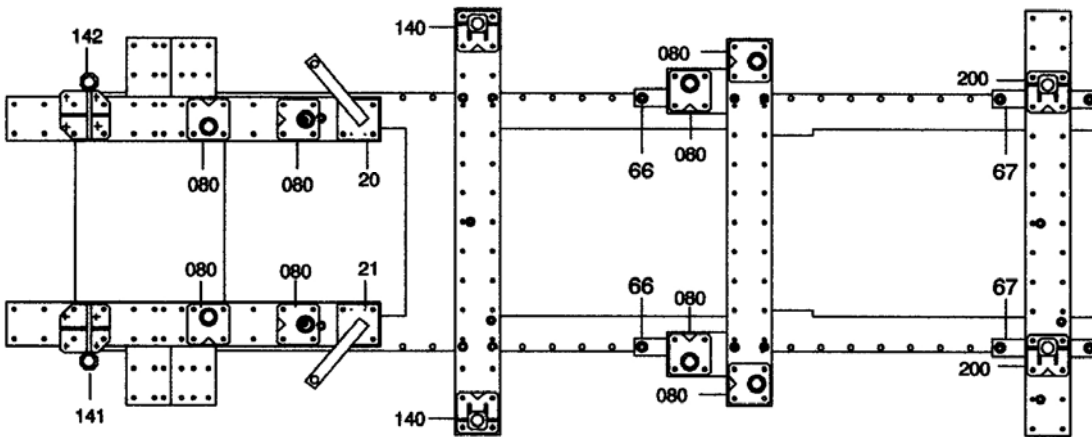

1 2 3 4 5 6 7 8 9 10 11 12 13 14 15 16 17 18 19 20 21 22 23 24 25 26 27 28 29 30 31 32 33 34 35 36

