

VAS 5020/4

○ Avec ou sans mécanique
 With or without mechanical elements
 Con o senza parti meccaniche
 Mit oder ohne Aggregate
 Con ó sin mecánica desmontada

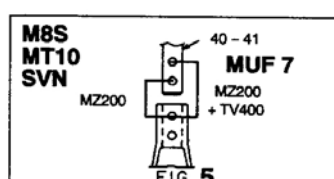

REP.	REFERENCE	PDS	NB	MZ
40	737.7040	2,3	1	200
41	737.7041	2,3	1	200
69	737.7069	2,9	1	200
70	737.7070	2,9	1	200
71	737.7071	2,4	1	
72	737.7072	2,4	1	
M 6-25			2	
M 8-40			4	
M 12-25			2	
complément au complementary set to complemento al zusatz zu				737.300
737.306				
15,5 Kg		16.10.98		431-D-6C

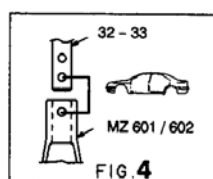
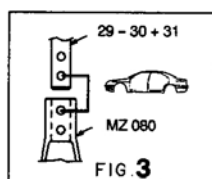
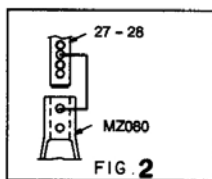
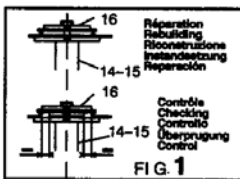
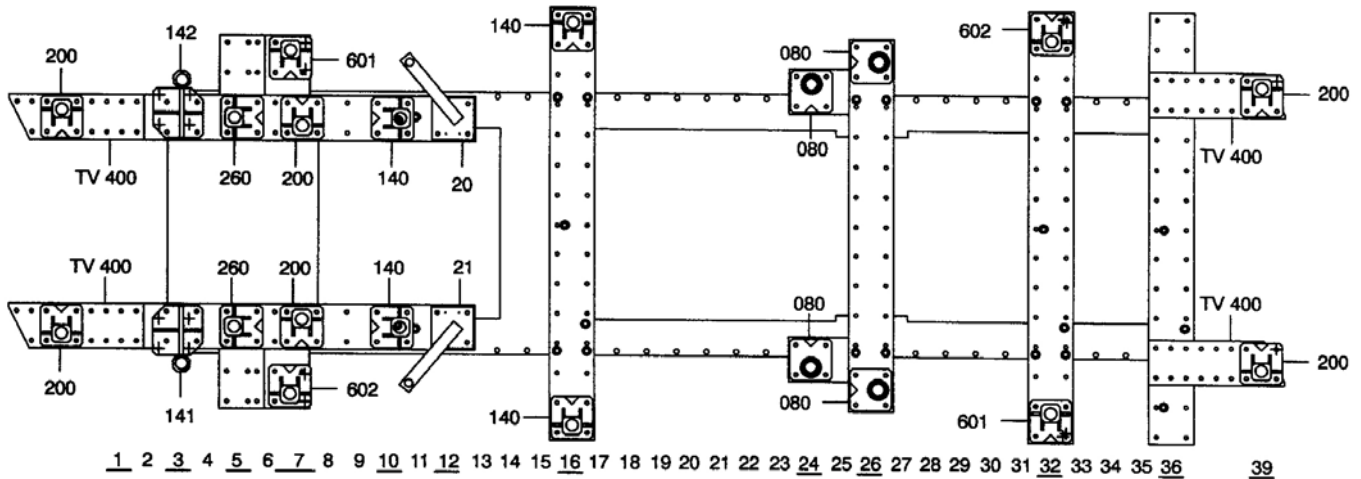

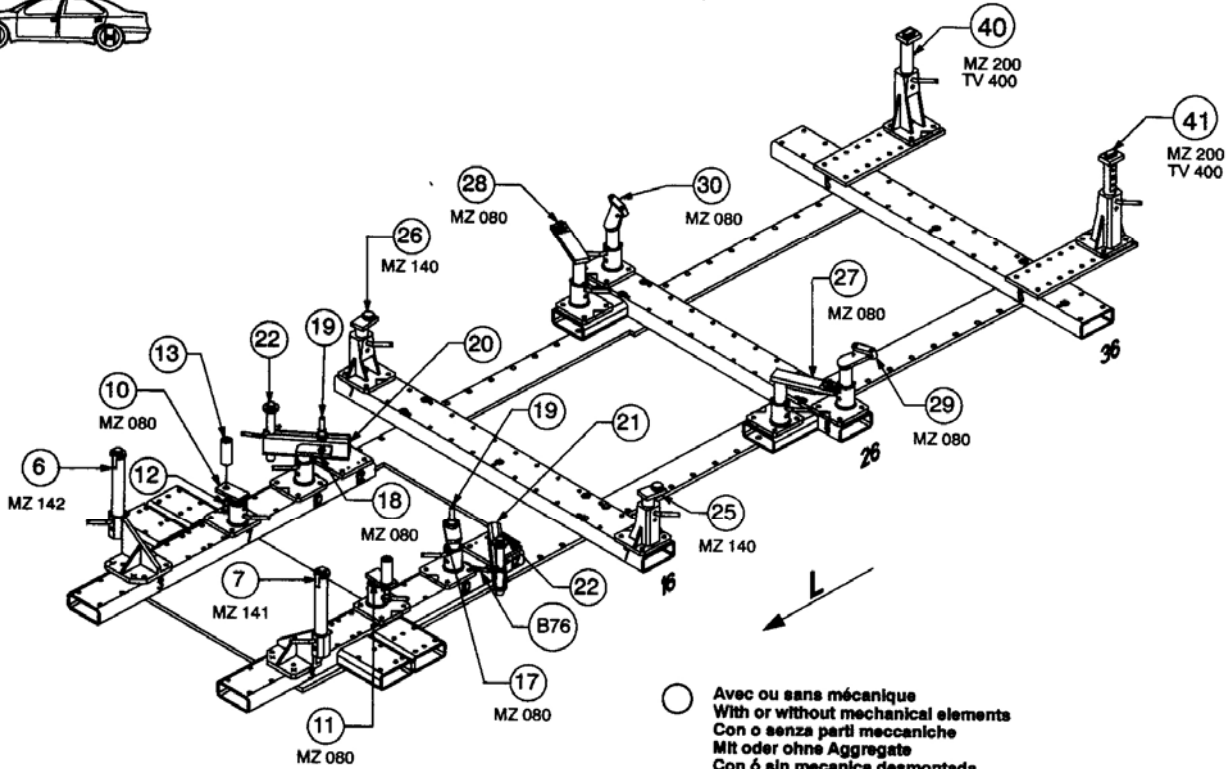

○ Avec ou sans mécanique
 With or without mechanical elements
 Con o senza parti meccaniche
 Mit oder ohne Aggregate
 Con ó sin mecanica desmontada

VAS 5020/4



737.306

15,5 Kg | 16.10.98 | 431-D-6D

