

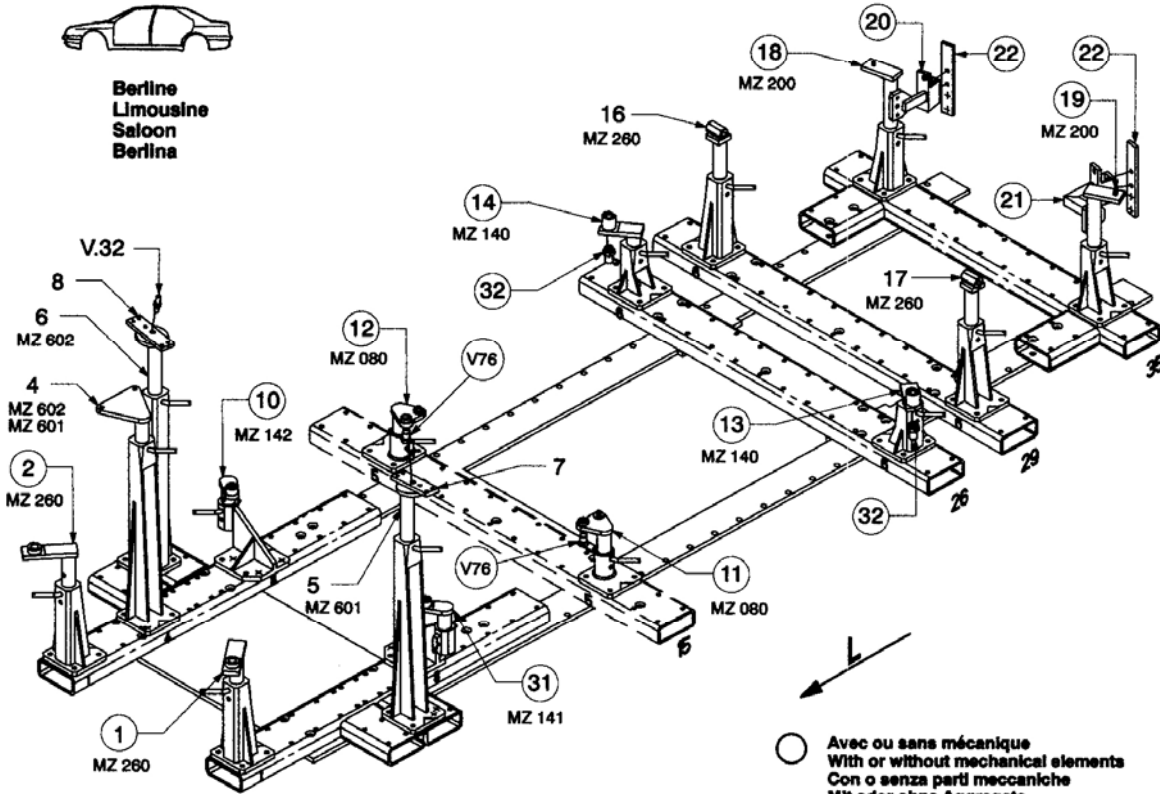

Berline
Limousine
Saloon
Berlina



○ Avec ou sans mécanique
With or without mechanical elements
Con o senza parti meccaniche
Mit oder ohne Aggregate
Con ó sin mecánica desmontada

RENAULT

REP.	REFERENCE	PDS	NB	MZ
1	715.7001	2,6	1	260/140
2	715.7002	2,6	1	260/140
3	715.7003	0,9	2	
4	715.7004	2,3	1	602/601
5	715.7005	1,7	1	601
6	715.7006	1,7	1	602
7	715.7007	0,7	1	
8	715.7008	0,7	1	
10	715.7010	1,7	1	142
11	715.7011	2,1	1	080
12	715.7012	2,1	1	080
13	715.7013	1,9	1	140/080
14	715.7014	1,9	1	140/080
16	715.7016	1,5	1	260
17	715.7017	1,5	1	260
18	715.7018	2,9	1	200
19	715.7019	2,9	1	200
20	715.7020	1,8	1	
21	715.7021	1,9	1	
22	715.7022	0,7	2	
23	715.7023	0,9	1	
24	715.7024	0,04	2	
31	715.7031	1,7	1	141
32	715.7032	0,2	2	
	CD.12	2,4	6	
	V.32	0,1	2	
	V.76	0,1	2	

M 8x16	8
M 10x30	2
M 10x25	20
M 12x55	2
M 12x90	1
CHc TB 12x25	12
M 12	2
M 10	2
M 12	2

715.330

57 Kg | 17.12.98 | 427-D-23R

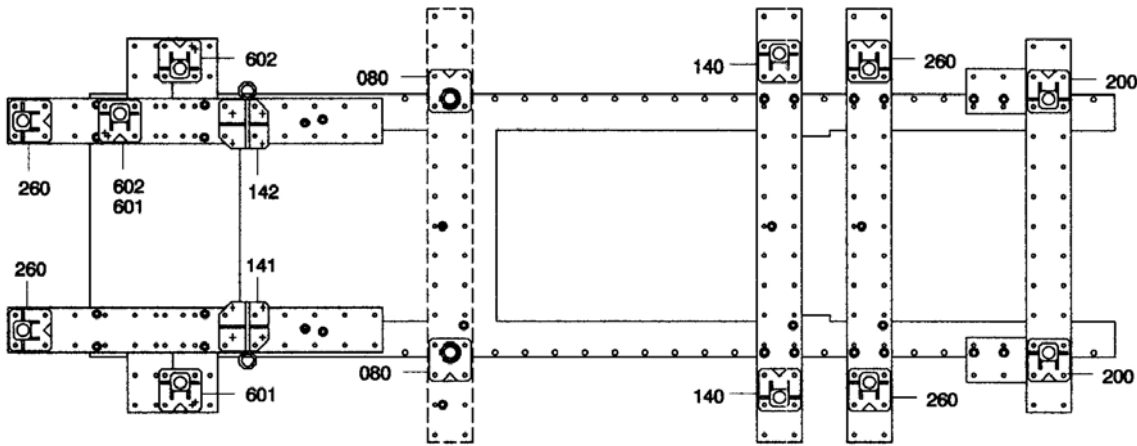

1 2 3 4 5 6 7 8 9 10 11 12 13 14 15 16 17 18 19 20 21 22 23 24 25 26 27 28 29 30 31 32 33 34 35 36

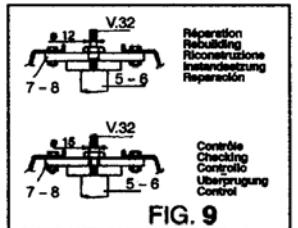
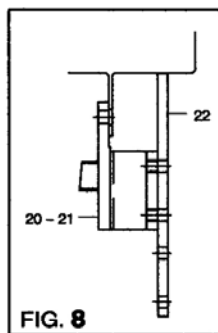
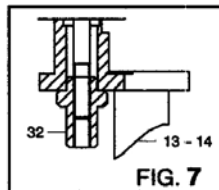
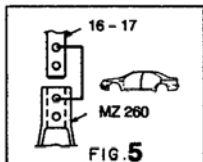
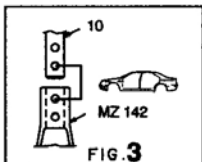
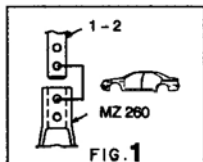
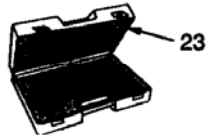



CELETTE®

RENAULT MEGANE



Berline
Limousine
Saloon
Berlina

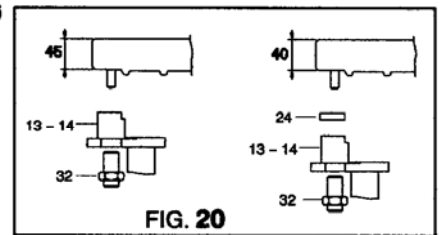
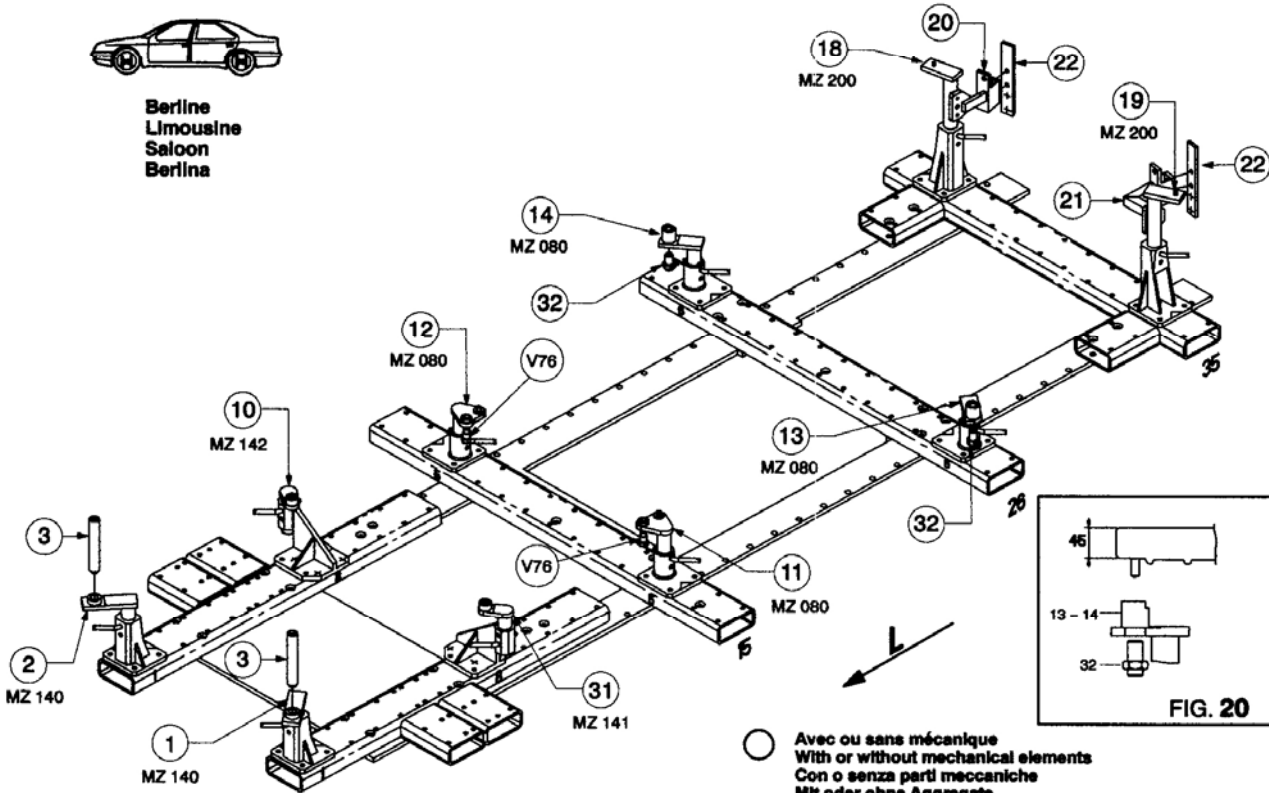

○ Avec ou sans mécanique
With or without mechanical elements
Con o senza parti meccaniche
Mit oder ohne Aggregate
Con ó sin mecánica desmontada

RENAULT

715.330

57 Kg	17.12.96	427-D-23S
-------	----------	-----------

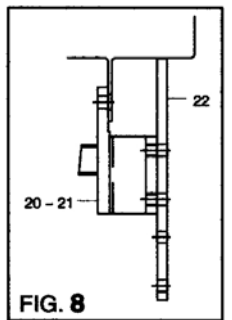
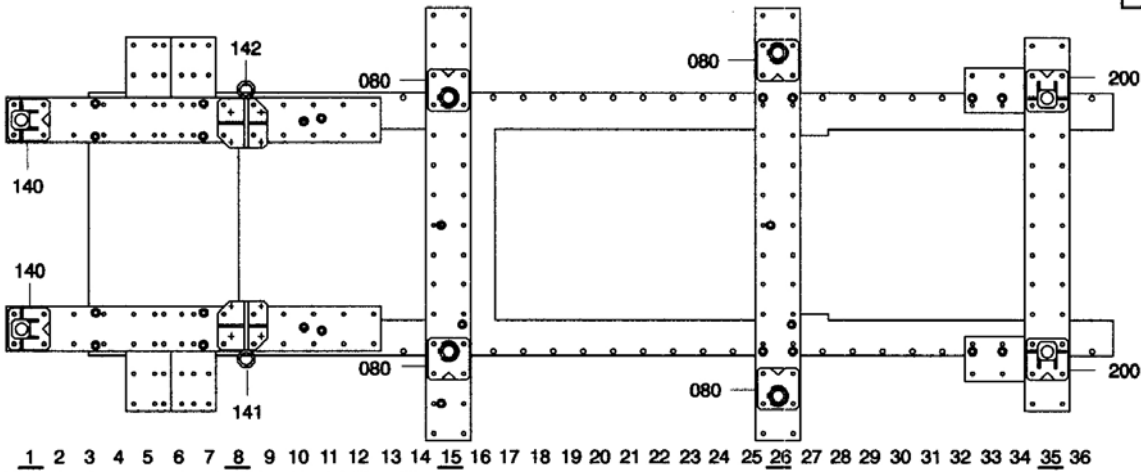

FIG. 8

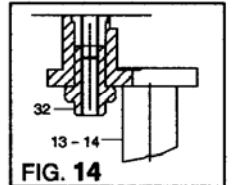
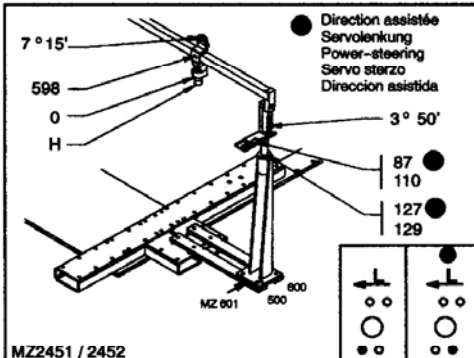

FIG. 14



MZ2451 / 2452

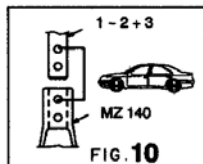

FIG. 10

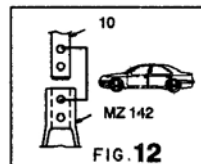

FIG. 12

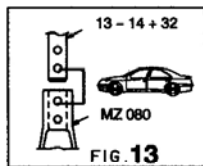

FIG. 13

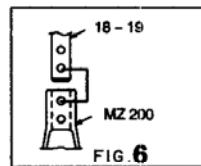

FIG. 6

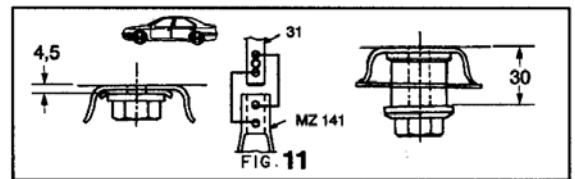

FIG. 11

CELETTE®

VENNE-FRANCE

© Copyright 1998 CELETTE S.A. - All rights reserved. No part of this document may be reproduced in any form, by photostat, xerography or any other means, or incorporated into any informational retrieval system, electronic or mechanical, without the permission of the copyright owner.



Coupé



Coupé

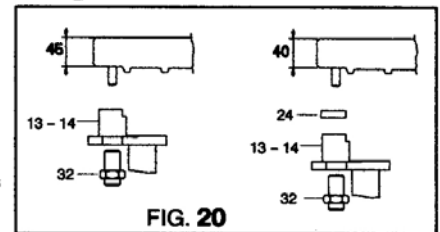
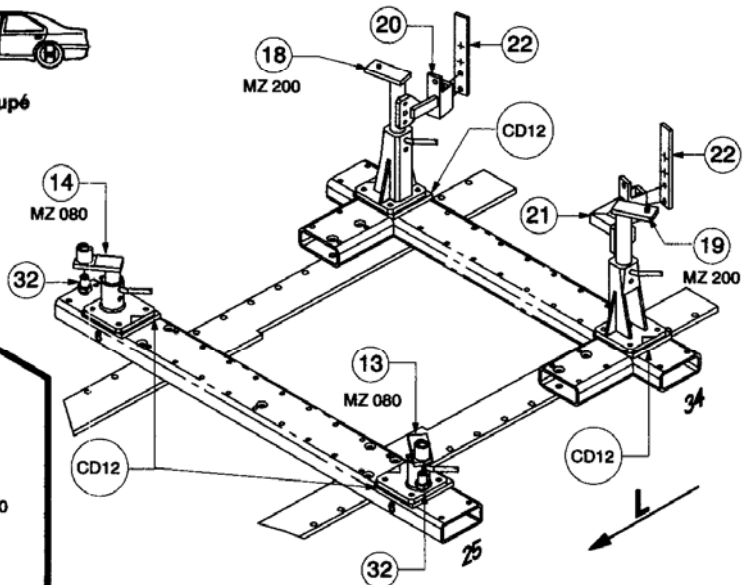
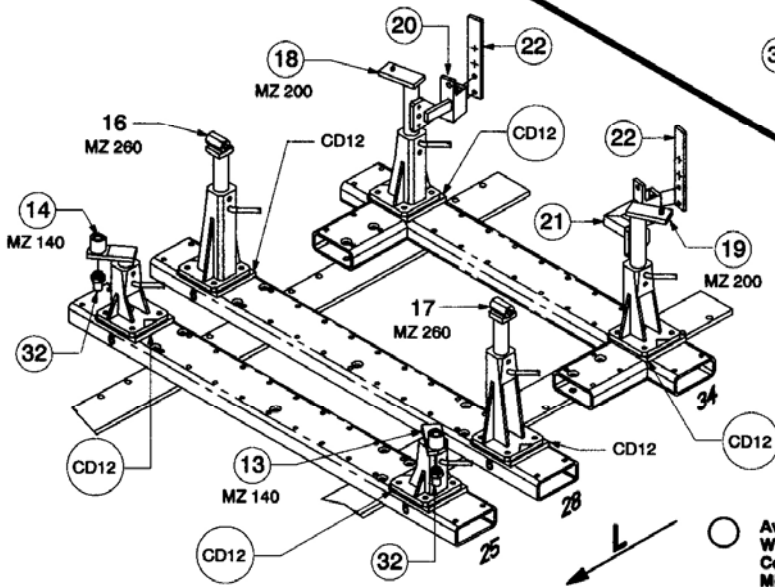

FIG. 20

○ Avec ou sans mécanique
 With or without mechanical elements
 Con o senza parti meccaniche
 Mit oder ohne Aggregate
 Con ó sin mecanica desmontada

RENAULT

715.330

57 Kg 17.12.98 427-D-23T

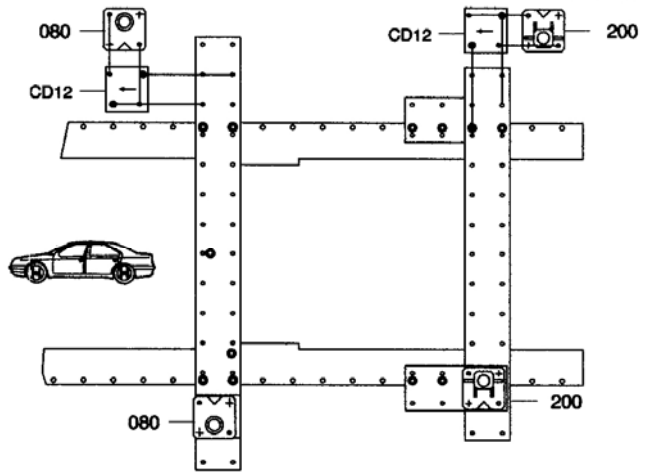
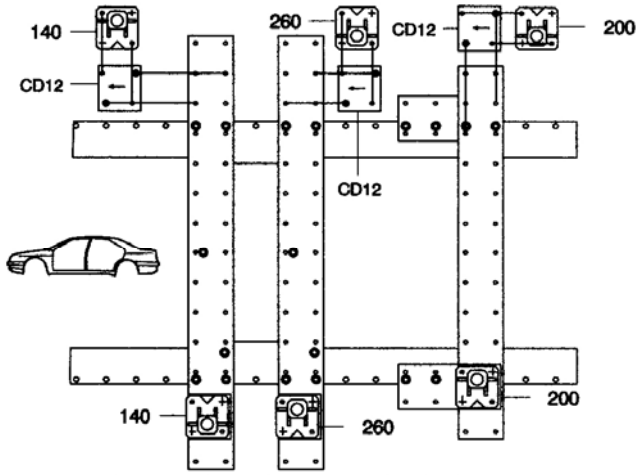

21 22 23 24 25 26 27 28 29 30 31 32 33 34 35 36

21 22 23 24 25 26 27 28 29 30 31 32 33 34 35 36

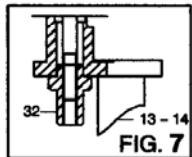

FIG. 7

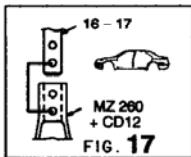

FIG. 17

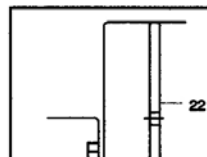

FIG. 15

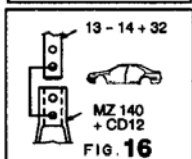

FIG. 16

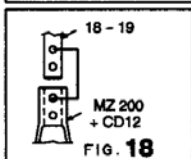

FIG. 18

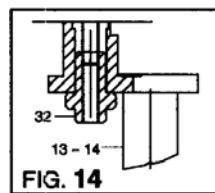

FIG. 14

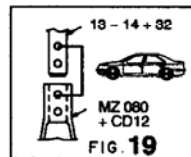

FIG. 19

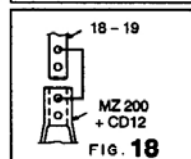

FIG. 18

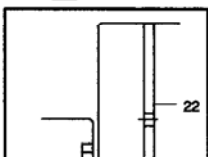

FIG. 15