

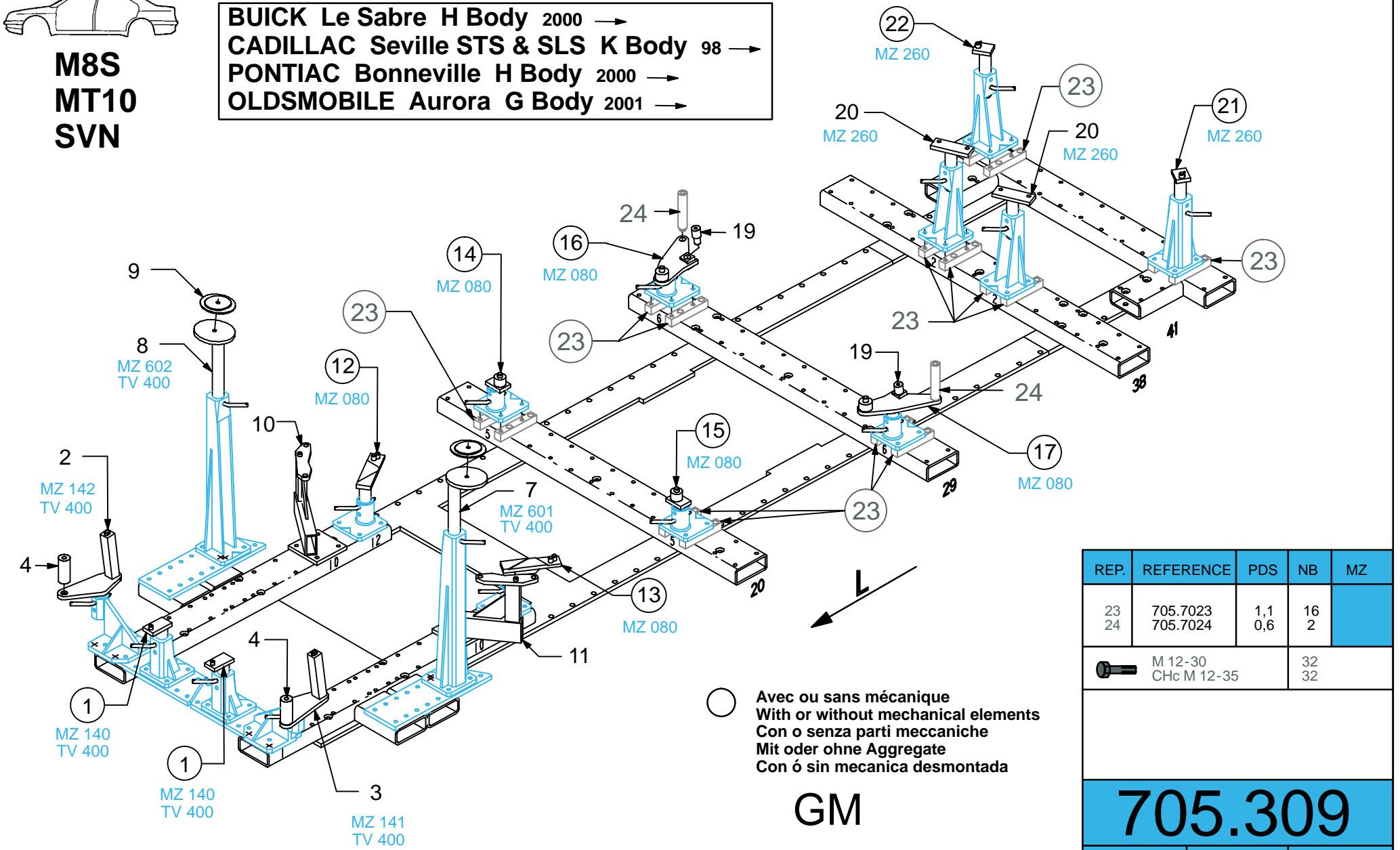

**M8S
MT10
SVN**

BUICK Le Sabre H Body 2000 →
CADILLAC Seville STS & SLS K Body 98 →
PONTIAC Bonneville H Body 2000 →
OLDSMOBILE Aurora G Body 2001 →



○ Avec ou sans mécanique
With or without mechanical elements
Con o senza parti meccaniche
Mit oder ohne Aggregate
Con ó sin mecanica desmontada

GM

REP.	REFERENCE	PDS	NB	MZ
23 24	705.7023 705.7024	1,1 0,6	16 2	

M 12-30 CHc M 12-35	32 32
------------------------	----------

705.309

21 Kg 08.12.2004 440-D-18D

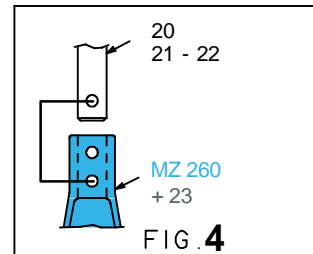
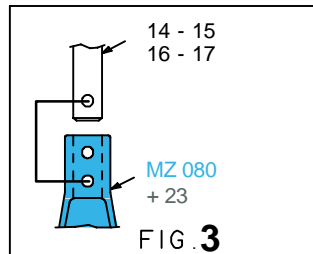
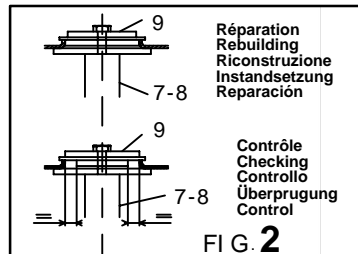
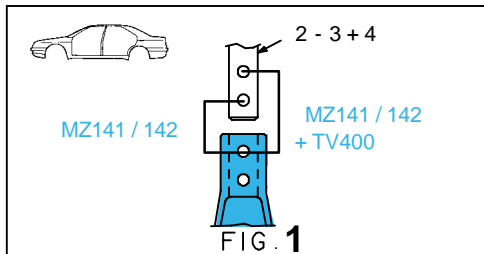
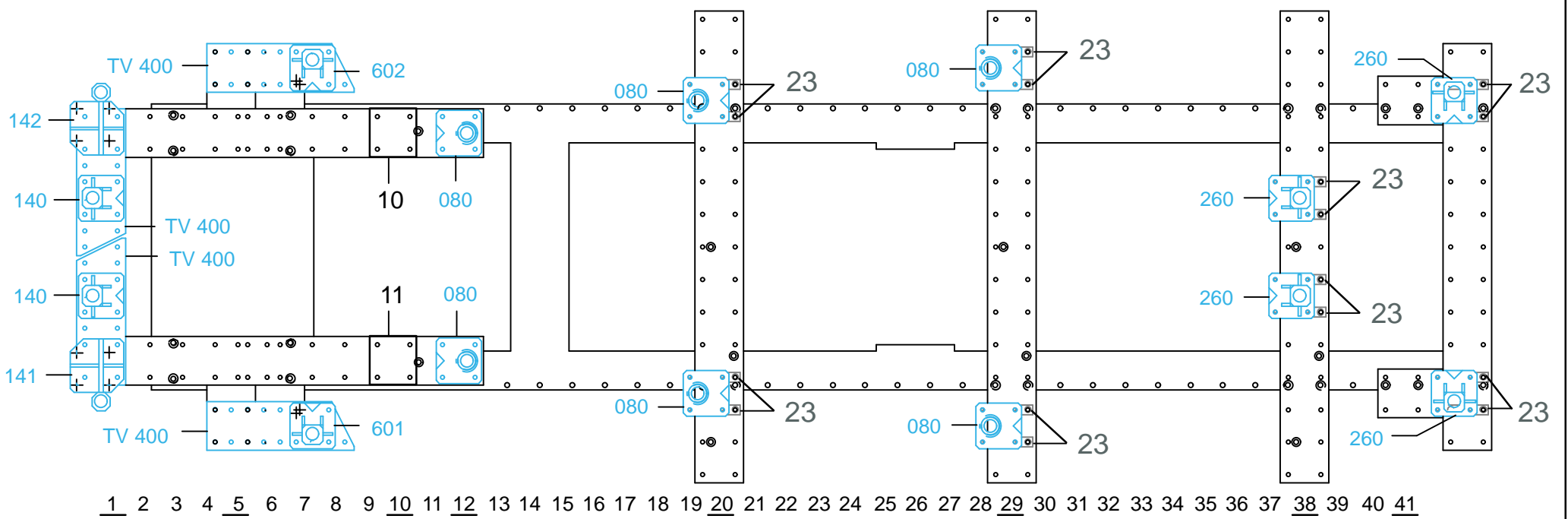

705.309-RVA3-1 00



**M8S
MT10
SVN**

CADILLAC Deville K Body 2000 →

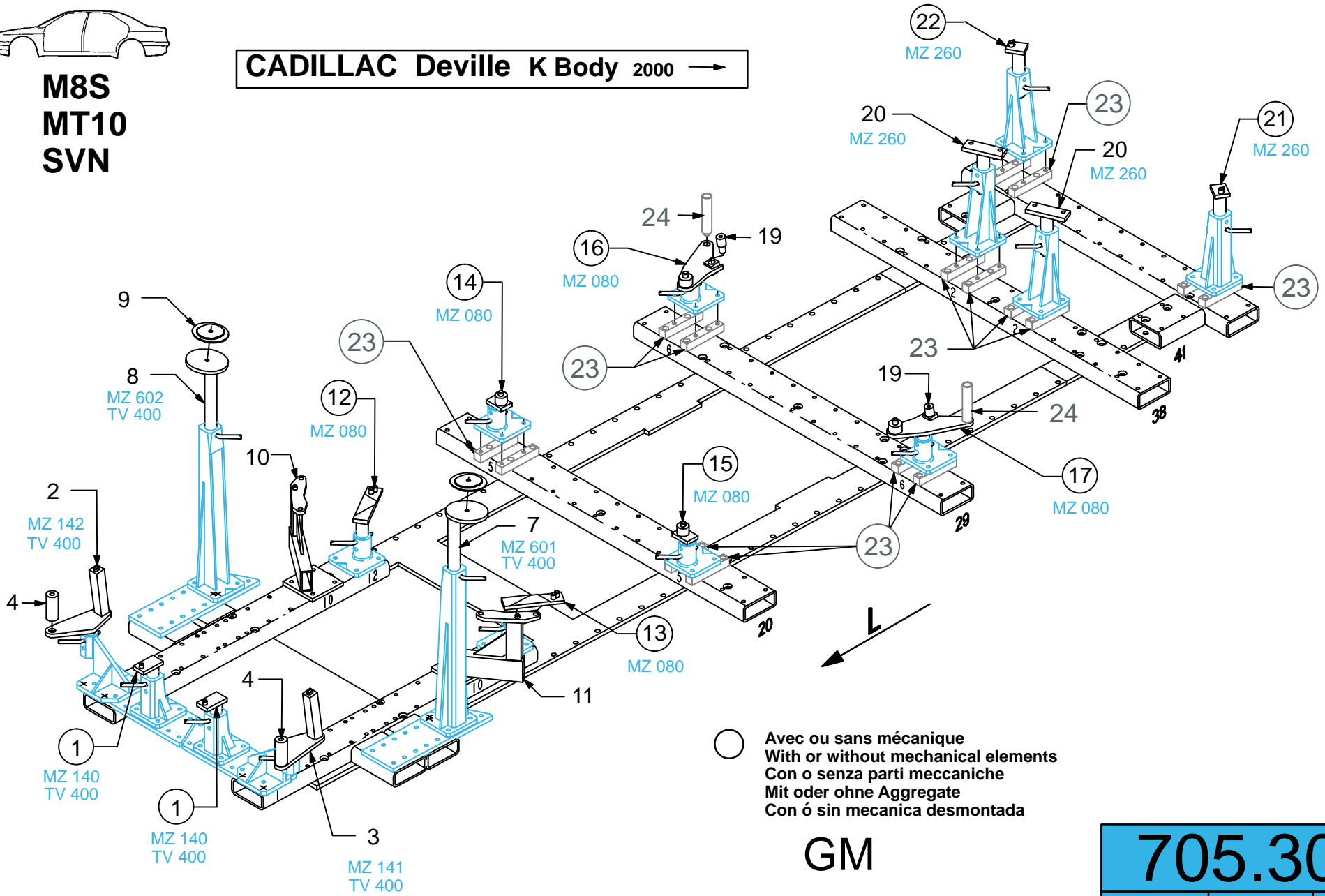

GM

705.309

21 Kg | 08.12.2004 | 440-D-18E

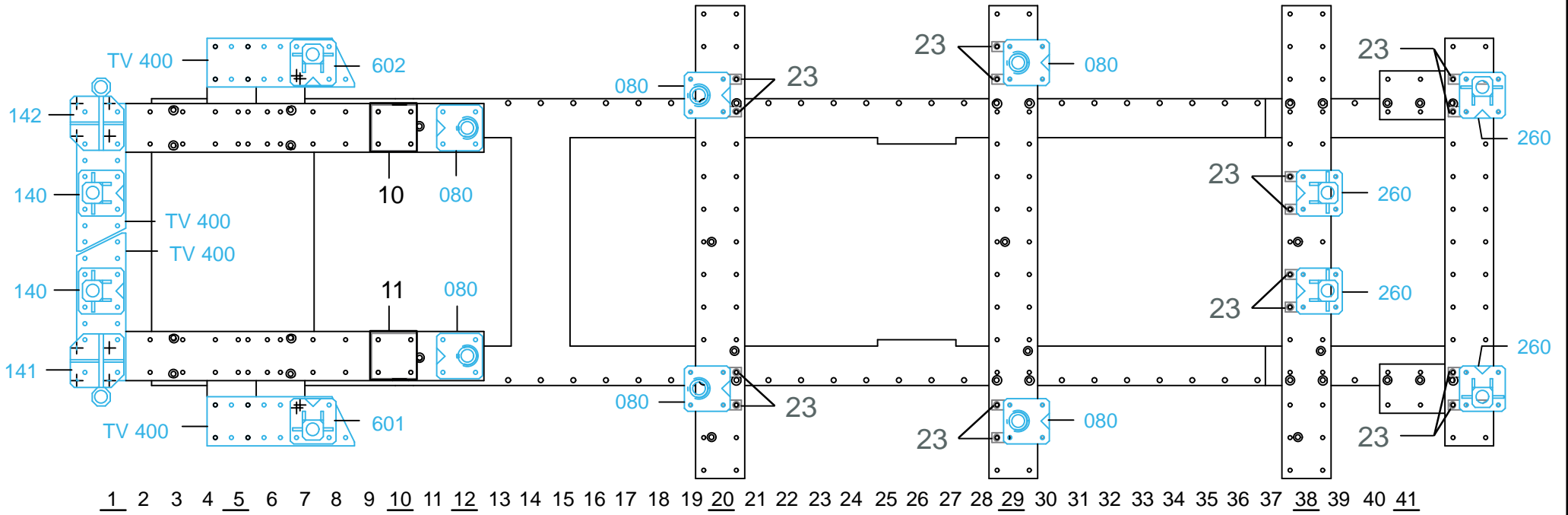

1 2 3 4 5 6 7 8 9 10 11 12 13 14 15 16 17 18 19 20 21 22 23 24 25 26 27 28 29 30 31 32 33 34 35 36 37 38 39 40 41

