

○ Avec ou sans mécanique
With or without mechanical elements
Con o senza parti meccaniche
Mit oder ohne Aggregate
Con ó sin mecanica desmontada

HONDA

REP.	REFERENCE	PDS	NB	MZ
1	702.7001	1,9	1	080/200
2	702.7002	1,9	1	080/200
3	702.7003	2,8	1	601
4	702.7004	2,8	1	602
5	702.7005	1,8	1	140/200
6	702.7006	1,8	1	140/200
7	702.7007	1,6	1	080
8	702.7008	1,6	1	080
9	702.7009	2,4	1	141
10	702.7010	2,4	1	142
11	702.7011	0,5	2	
12	702.7012	2,8	1	140/200
13	702.7013	2,8	1	140/200
14	702.7014	2,1	1	602
15	702.7015	2,1	1	601
16	702.7016	1,7	1	260
17	702.7017	1,7	1	260
18	702.7018	0,3	2	

	M 12x20	2
	M 12x70	4
	M 12.125x90	2
	M 12.125x130	2
	M 12.125x140	2
	M 12.125x220	2
	M 14.150x60	2
M 14.150x160	4	
M 14.150x220	2	

	M 12	4
--	------	---

702.300

38 Kg 02.01.95 413-D-23A

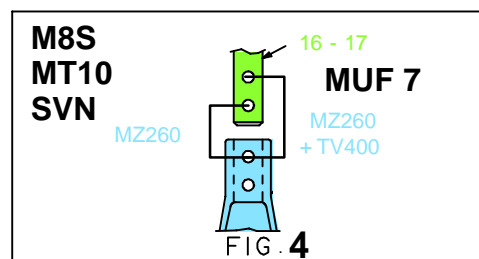
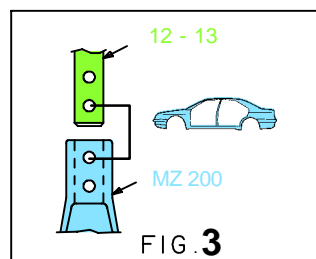
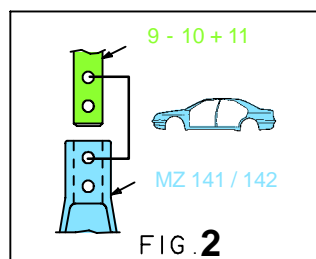
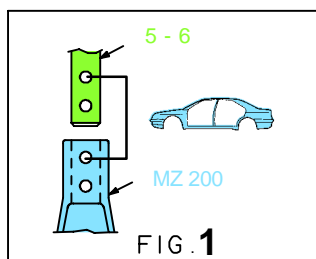
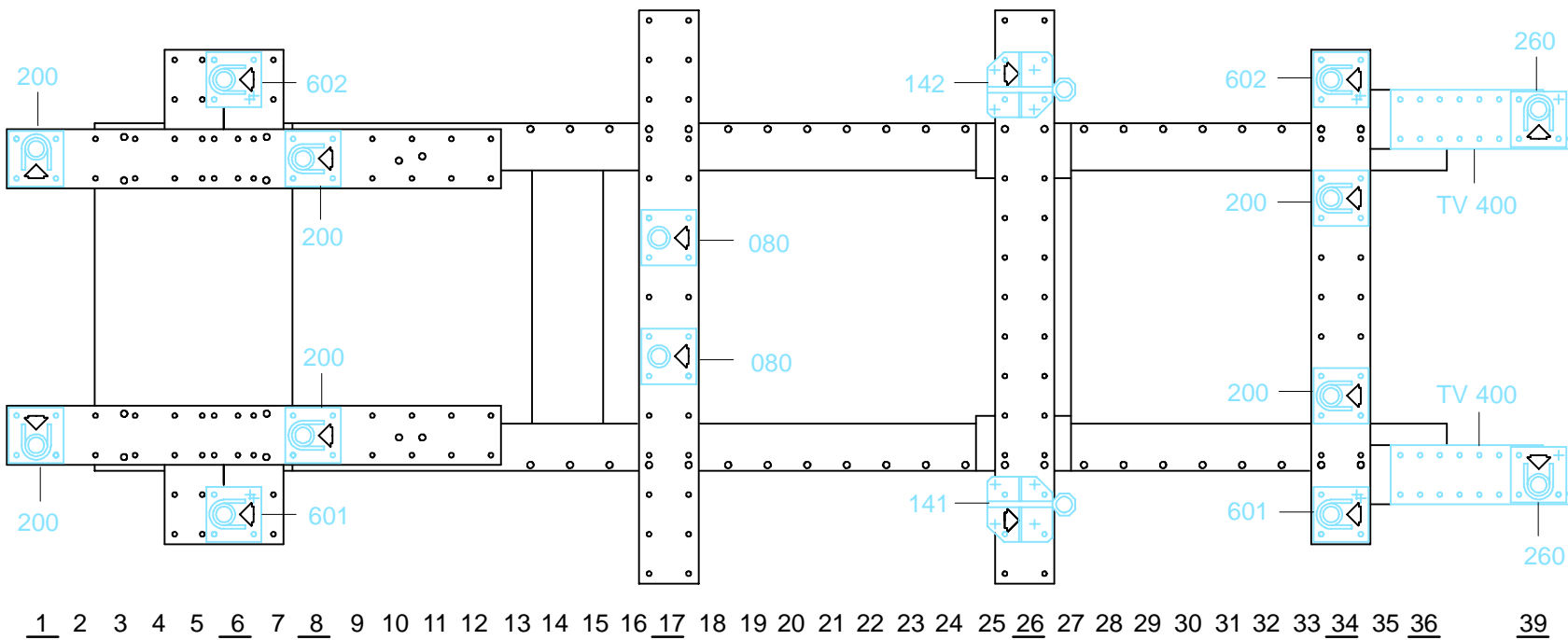

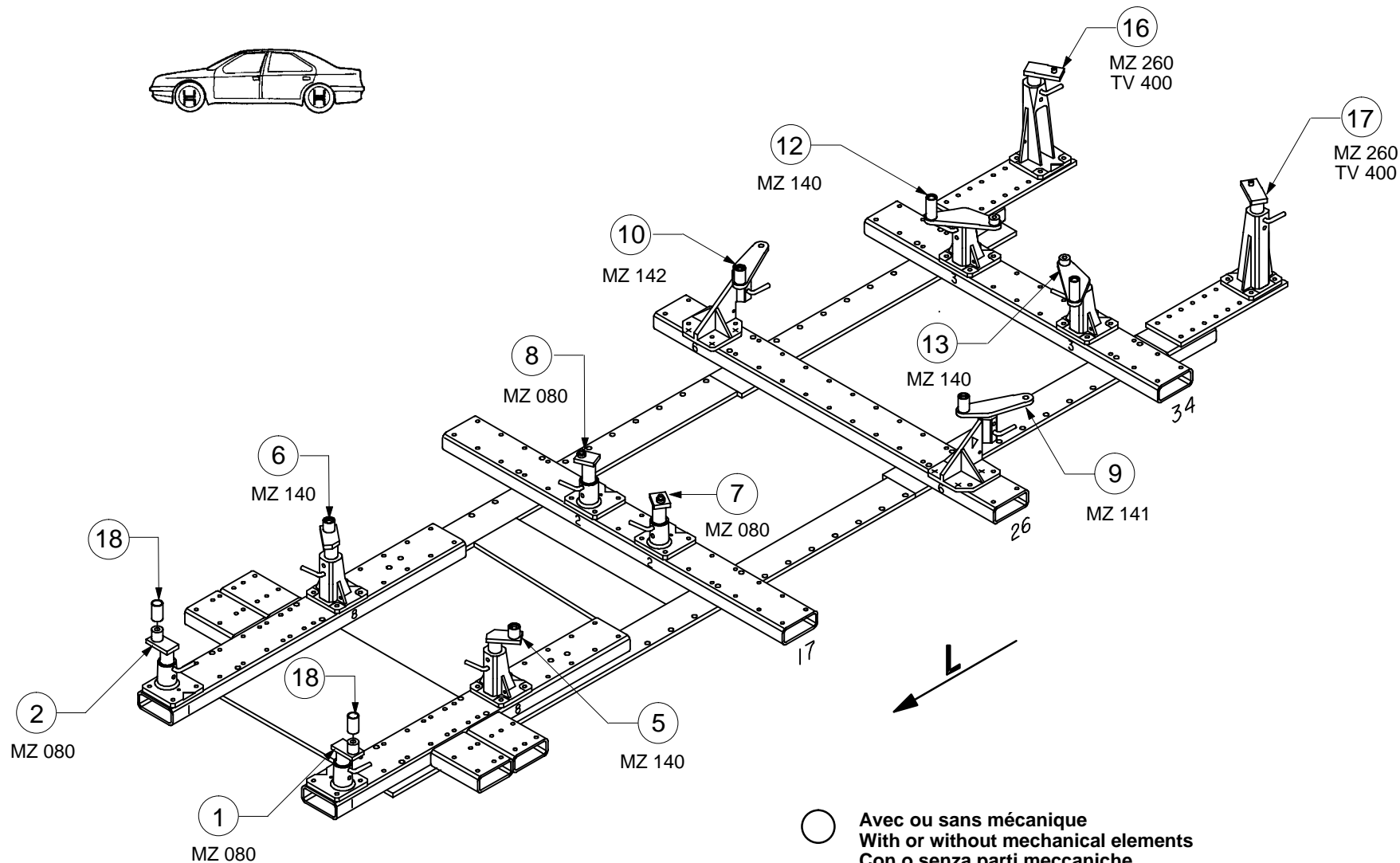
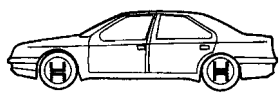

○ Avec ou sans mécanique
With or without mechanical elements
Con o senza parti meccaniche
Mit oder ohne Aggregate
Con ó sin mecanica desmontada

HONDA

702.300

38 Kg 02.01.95 413-D-23B

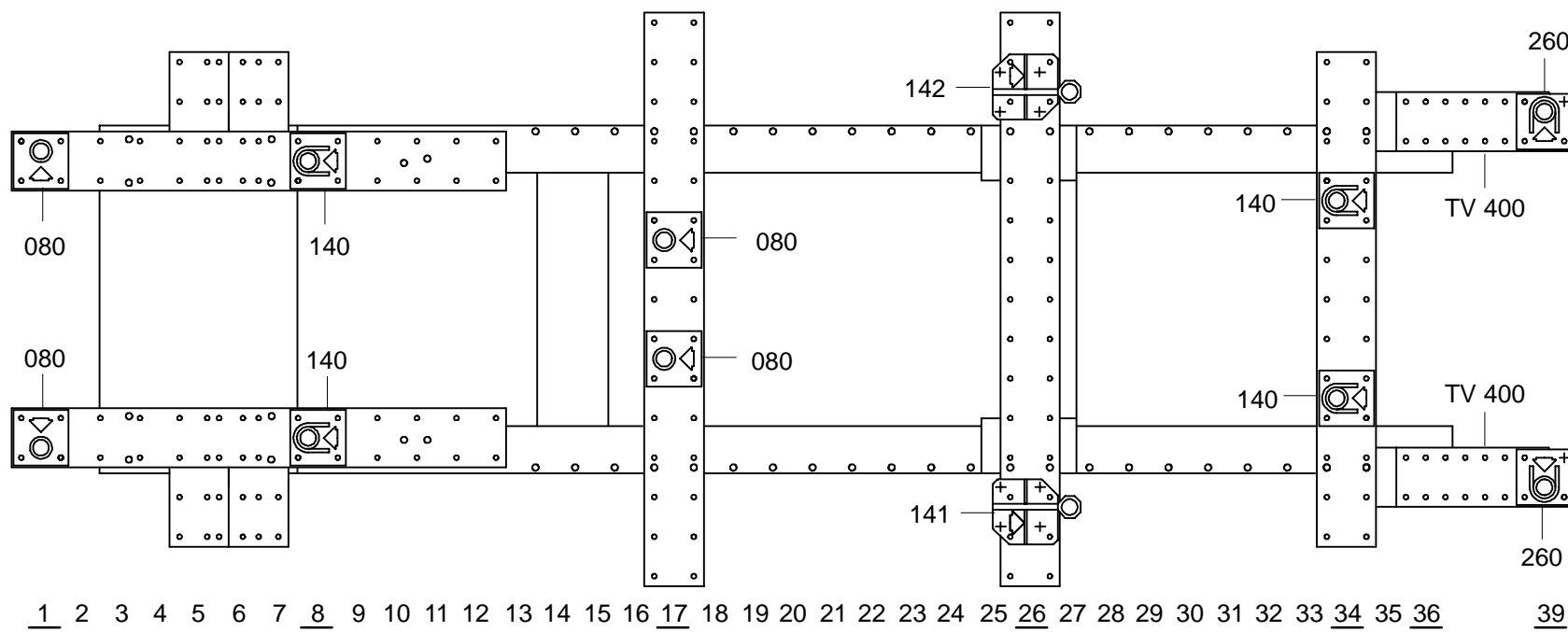

1 2 3 4 5 6 7 8 9 10 11 12 13 14 15 16 17 18 19 20 21 22 23 24 25 26 27 28 29 30 31 32 33 34 35 36 39

