

○ Avec ou sans mécanique
 With or without mechanical elements
 Con o senza parti meccaniche
 Mit oder ohne Aggregate
 Con ó sin mecanica desmontada

RENAULT

REP.	REFERENCE	PDS	NB	MZ
1	675.701	2,9	1	
2	675.702	2,9	1	
3	675.703	0,2	4	
4	675.704	0,3	2	
5	675.705	2,7	1	142
6	675.706	2,7	1	141
7	675.707	0,3	2	
8	675.708	3,0	1	601
9	675.709	3,1	1	260
10	675.710	3,4	1	602
11	675.711	3,4	1	601
12	675.712	1,4	1	
13	675.713	1,4	1	
14	675.714	2,4	1	260/080
15	675.715	2,4	1	260/080
16	675.716	0,1	2	
17	675.717	1,6	1	140/080
18	675.718	1,6	1	140/080
19	675.719	0,1	2	
20	675.720	0,1	2	
21	675.721	2,4	1	080
22	675.722	2,4	1	080
23	675.723	1,6	1	080
24	675.724	1,6	1	080
25	675.725	2,3	1	080
26	675.726	2,3	1	080
27	675.727	0,3	2	
28	675.728	0,1	2	
29	675.729	2,6	1	200
30	675.730	2,6	1	200
31	675.731	3,3	1	200
32	675.732	3,3	1	200
34	675.734	0,9	1	
35	675.735	1,6	1	
36	675.736	1,6	1	
	V.32	0,1	2	
	M 8x25 M 8x80 M 8x100 M 10x30 M 12x16 M 12x20 M 12x30 M 12x40 M 12x45 M 14x130		14 2 2 2 2 4 2 4 4 4 2	
	M 8 M 12 M 14		4 14 2	
	M 12 L 12		4 2	
675.310				
68 Kg	20.06.95	427-D-22D		

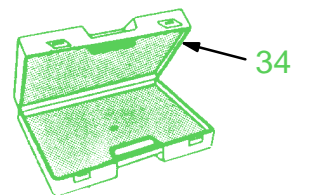

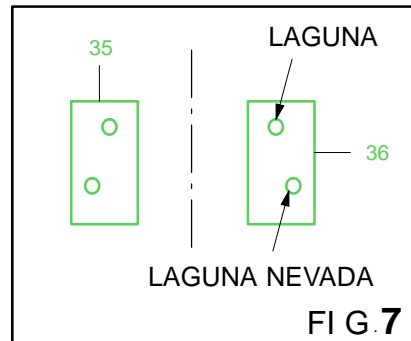
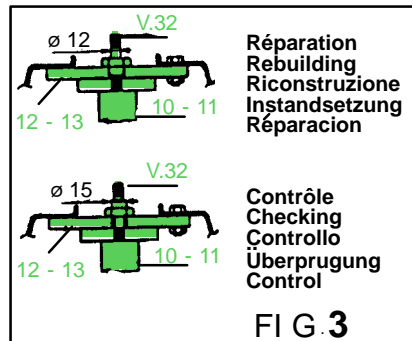
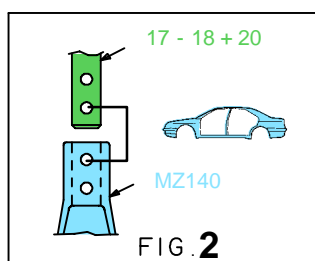
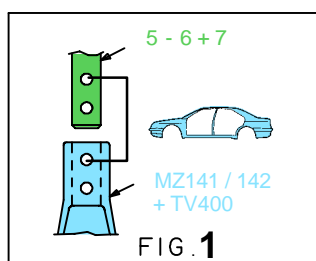
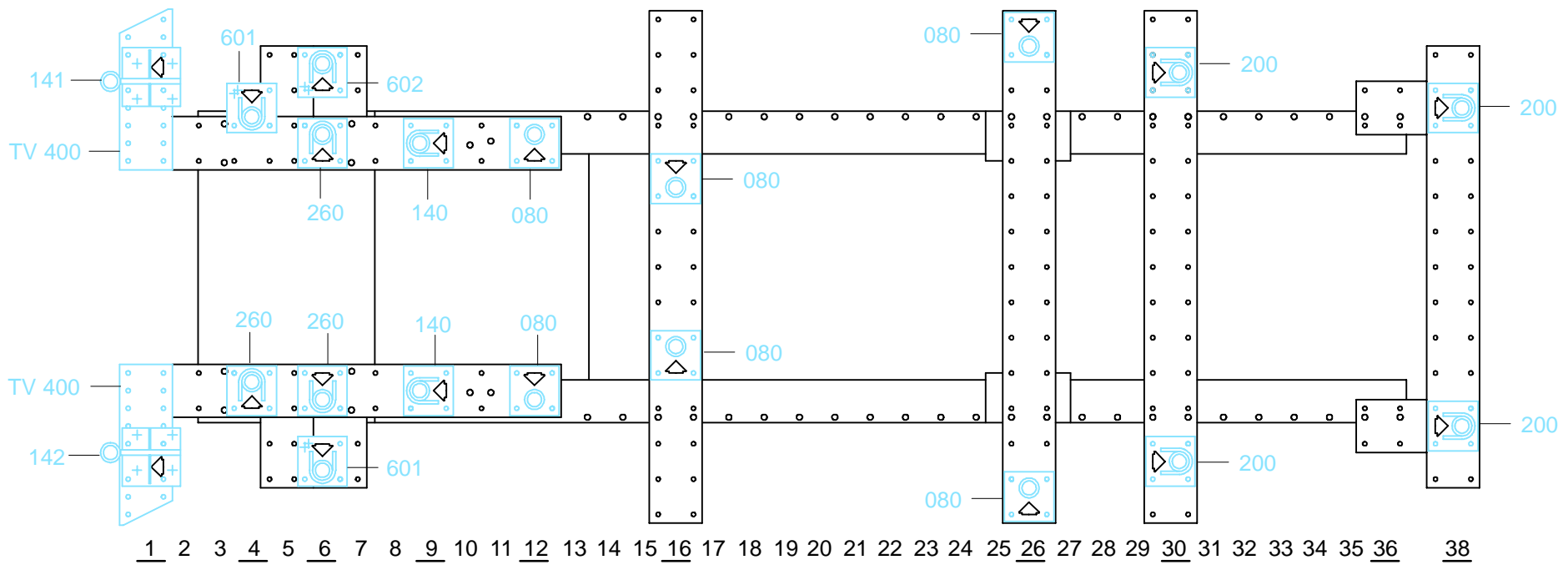
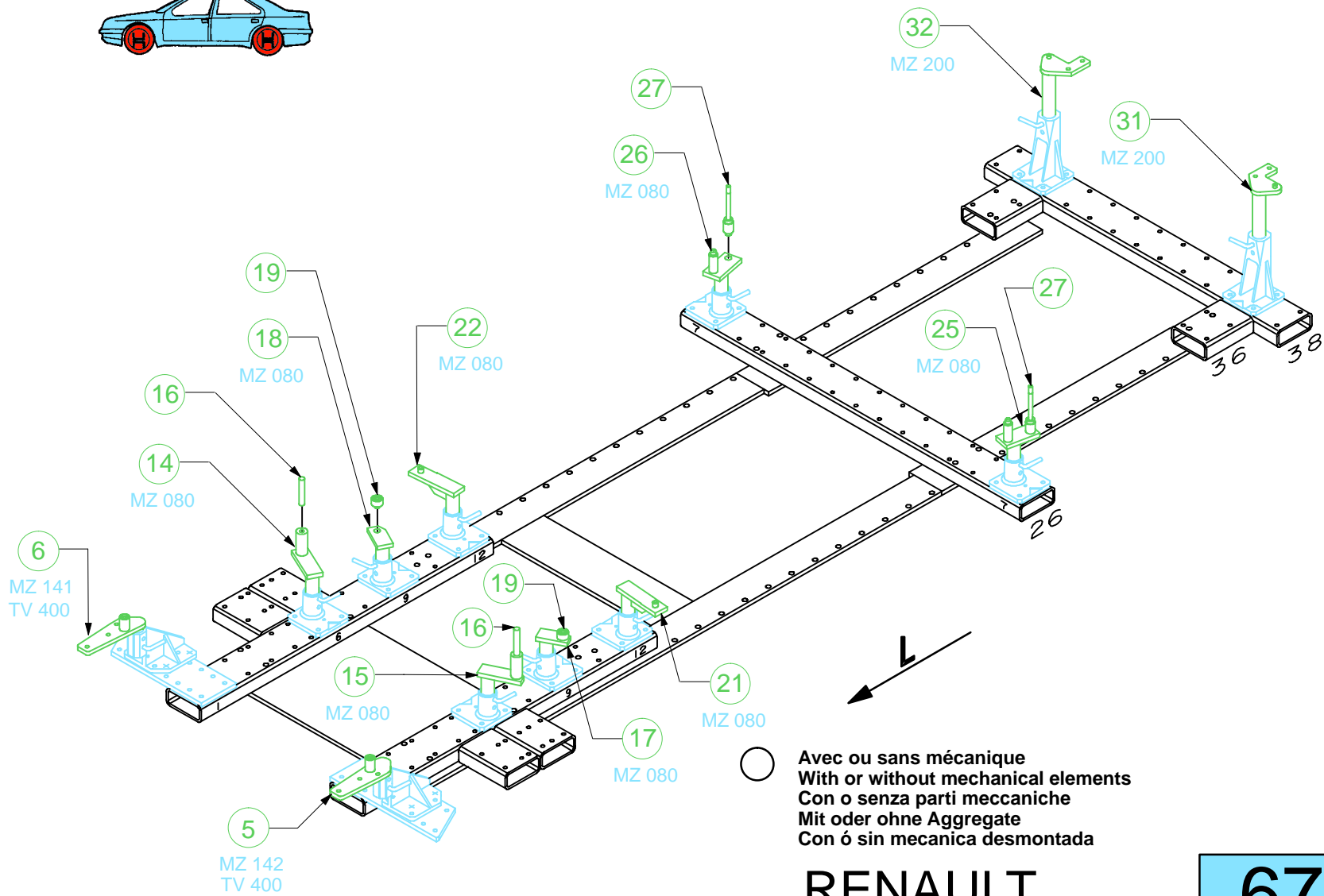
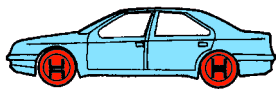

RENAULT

675.310

68 Kg | 20.06.95 | 427-D-22E

