

Avec ou sans mécanique  
With or without mechanical elements  
Con o senza parti meccaniche  
Mit oder ohne Aggregate  
Con ó sin mecanica desmontada

**CITROEN**

REP.	REFERENCE	PDS	NB	MZ
2	670.702	3,4	1	142
3	670.703	1,5	2	
4	670.704	3,2	1	200
5	670.705	3,2	1	200
6	670.706	1,8	1	260/080
7	670.707	1,7	1	260/080
8	670.708	0,6	1	
9	670.709	0,4	1	
10	670.710	1,5	1	602
11	670.711	1,5	1	601
12	670.712	1,7	2	
13	670.713	2,7	1	080
14	670.714	2,7	1	080
15	670.715	1,8	1	080
16	670.716	1,8	1	080
17	670.717	2,4	1	140
18	670.718	2,4	1	140
19	670.719	2,4	1	200
20	670.720	2,4	1	200
21	670.721	1,6	2	
22	670.722	0,6	2	
23	670.723	2,9	1	140
24	670.724	2,9	1	140
25	670.725	2,7	1	260
27	670.727	3,6	1	141
28	670.728	0,7	2	
	V.32	0,1	2	
	B.86	0,1	2	

	M 6x25	2
	M 8x16	4
	M 10x25	1
	M 12x25	4
	M 12x30	4
	M 12x40	2
	M 12x65	6
	M 12x90	4
M 12x120	2	
M 16x20	2	
	M 10	1
	MU 12	2

**670.310**

62 Kg    08.01.96    408-D-12E

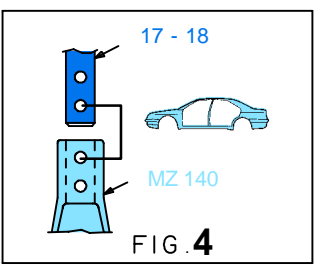
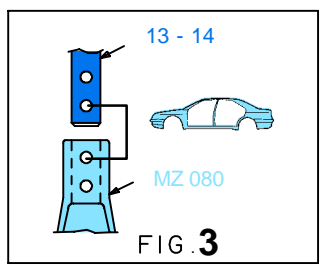
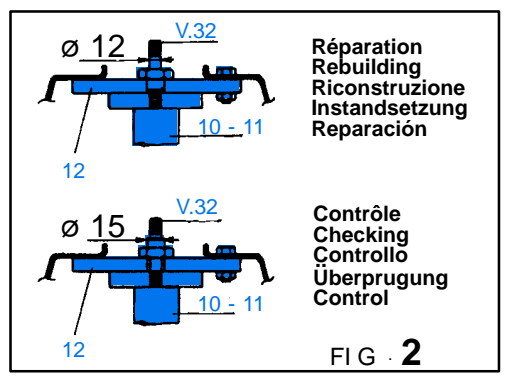
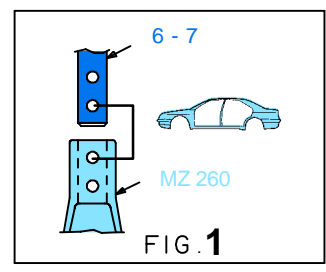
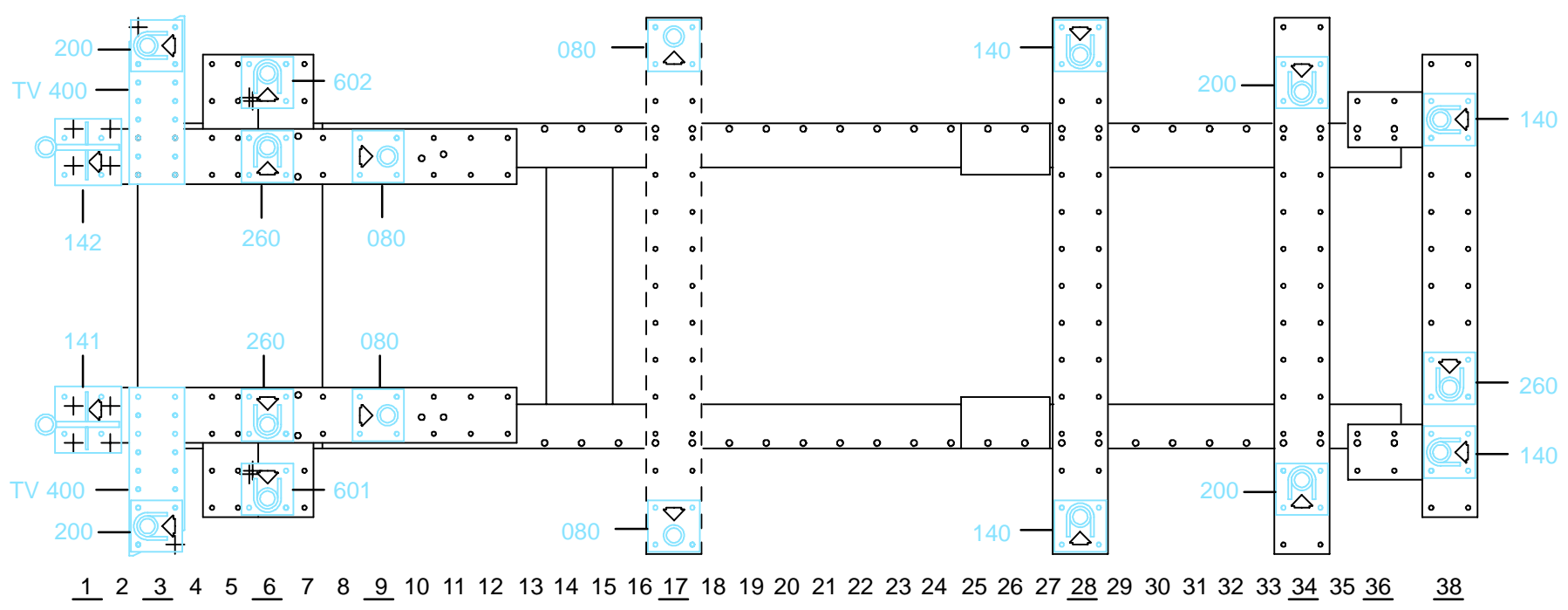

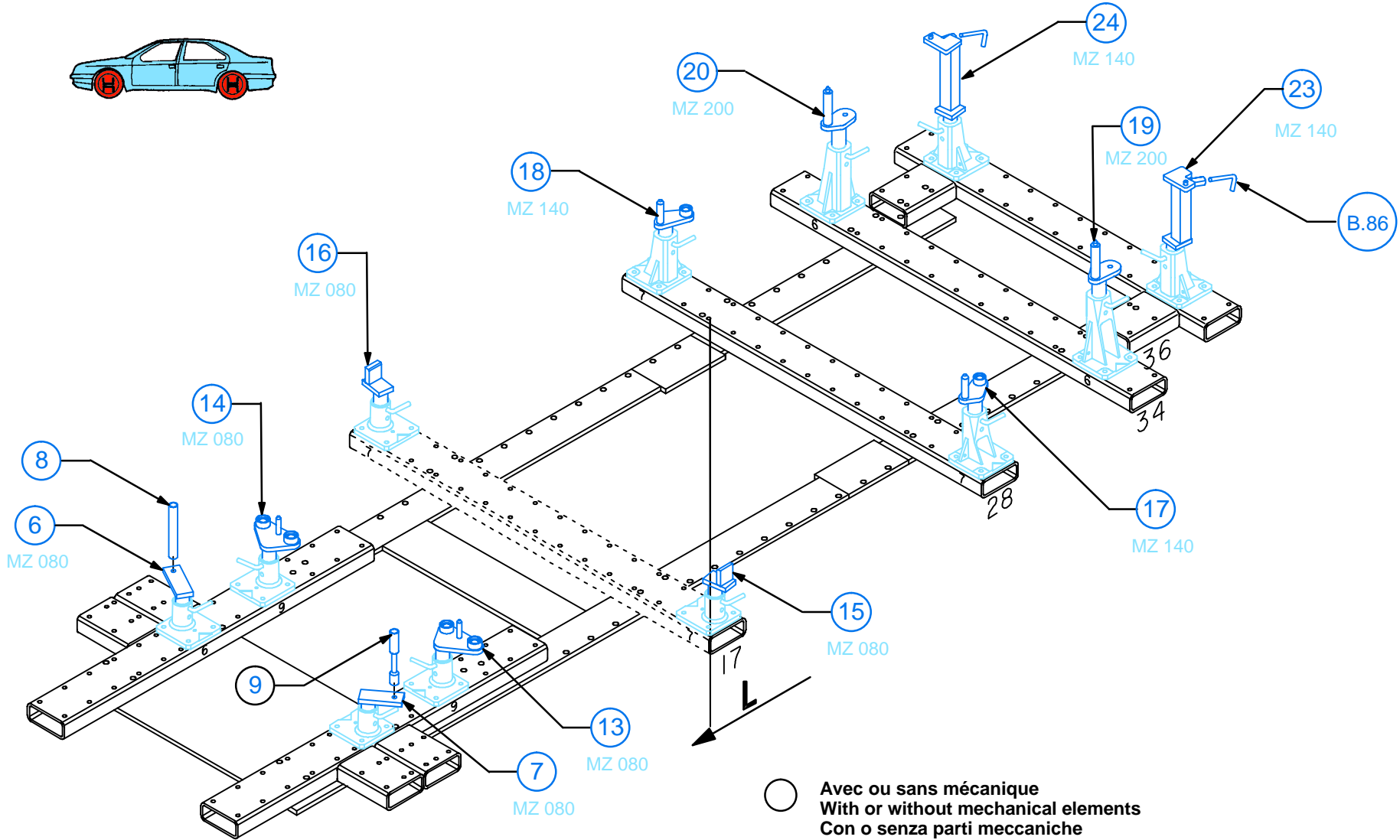
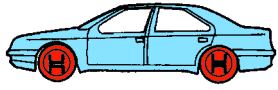

○ Avec ou sans mécanique  
With or without mechanical elements  
Con o senza parti meccaniche  
Mit oder ohne Aggregate  
Con ó sin mecanica desmontada

**CITROEN**

**670.310**

62 Kg | 08.01.96 | 408-D-12F

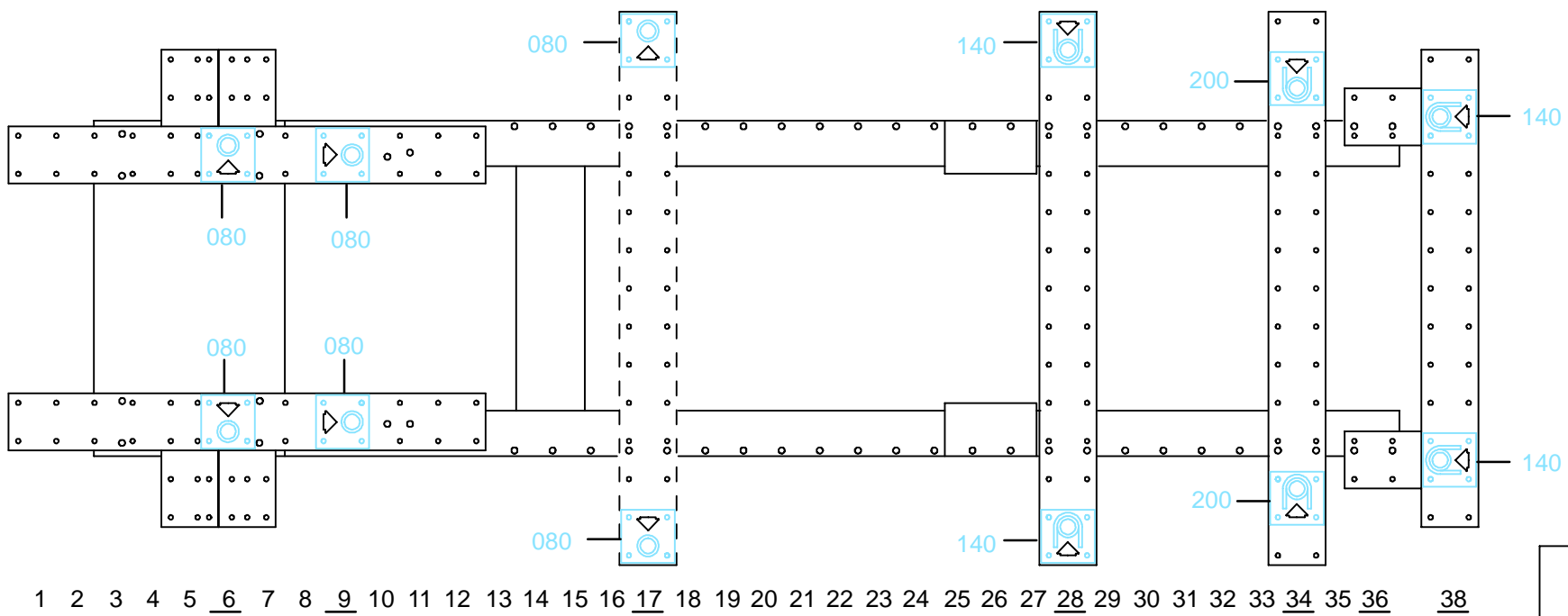

1 2 3 4 5 6 7 8 9 10 11 12 13 14 15 16 17 18 19 20 21 22 23 24 25 26 27 28 29 30 31 32 33 34 35 36 38

