

○ Avec ou sans mécanique
 With or without mechanical elements
 Con o senza parti meccaniche
 Mit oder ohne Aggregate
 Con ó sin mecánica desmontada

REP.	REFERENCE	PDS	NB	MZ
86	642.786	2,6	1	080
87	642.787	2,6	1	080
88	642.788	2,4	1	140
89	642.789	2,4	1	140
90	642.790	2,5	1	200
91	642.791	2,5	1	200
92	642.792	5,3	1	260
93	642.793	5,3	1	260
94	642.794	1,3	1	
95	642.795	1,3	1	
96	642.796	3,6	1	260
97	642.797	3,5	1	260
98	642.798	3,4	1	200
99	642.799	3,4	1	200

	M 10.125x30	1
	M 10.125x60	1
	M 12x45	4
	M 12.125x140	4
	M 12.125x150	4
	M 12	4

complément au
 complementary set to
 complemento al
 zusatz zu

642.300
 +
642.304

642.303

43 Kg 06.02.97 413-D-19N

HONDA

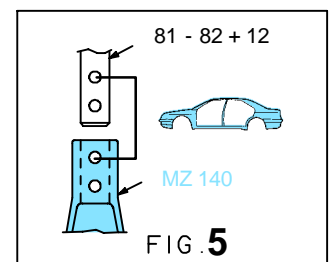
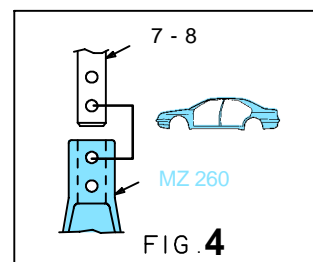
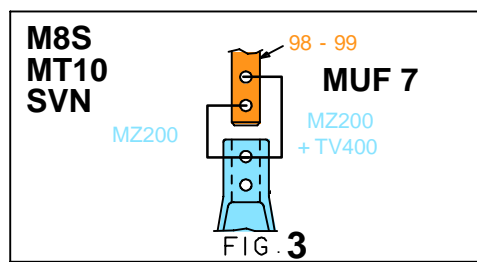
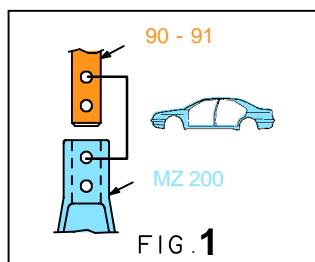
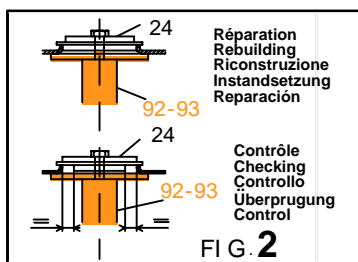
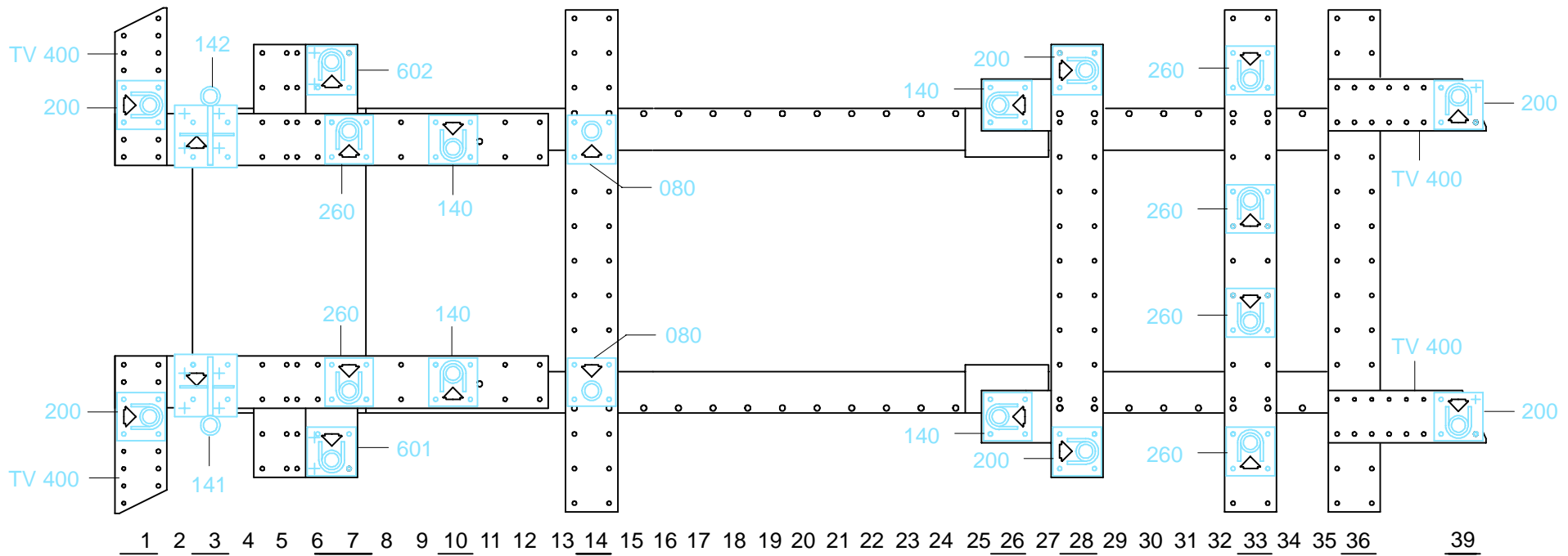

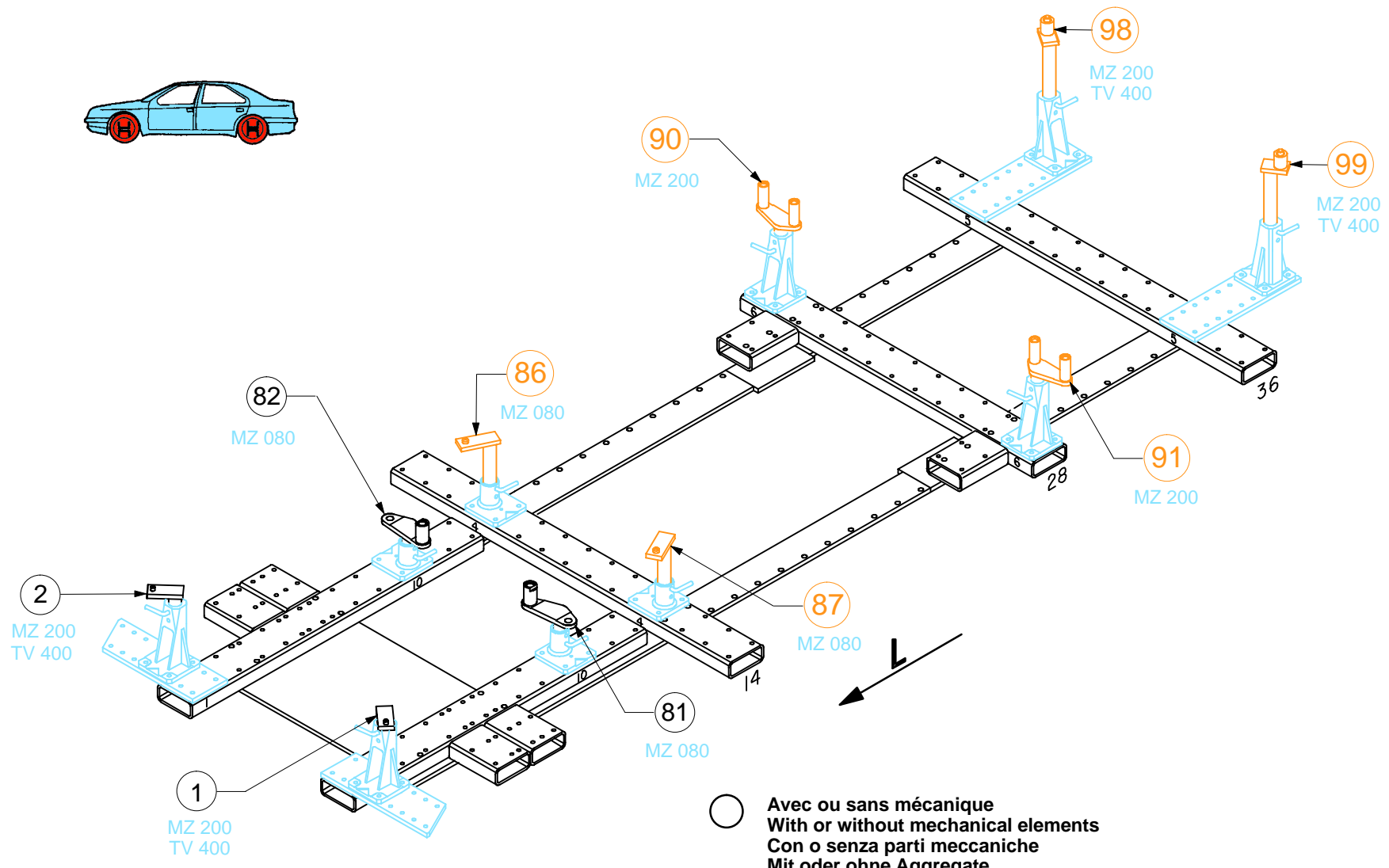

HONDA

642.303

43 Kg 06.02.97 413-D-19P

