



REP.	REFERENCE	PDS	NB	MZ
1	595.701	2,3	1	260
2	595.702	2,2	1	260
3	595.703	2,7	1	260
4	595.704	2,7	1	260
5	595.705	2,1	1	601
6	595.706	2,1	1	602
7	595.707	0,3	2	
8	595.708	2,1	1	080
9	595.709	2,4	1	080
10	595.710	1,9	1	080
11	595.711	1,7	1	080
12	595.712	2,5	1	140
13	595.713	2,5	1	140
14	595.714	2,4	1	200
15	595.715	2,0	1	200
16	595.716	3,2	1	200
17	595.717	3,2	1	200
18	595.718	0,1	2	
	V.67	0,1	1	
	V.60	0,1	2	

	M8x30 M10x70 M12x25 M12x120	1 2 4 1
	M12x80 M12x140	2 2

○ Avec ou sans mécanique
With or without mechanical elements
Con o senza parti meccaniche
Mit oder ohne Aggregate
Con ó sin mecánica desmontada

RENAULT

595.300

39 Kg | 19.04.90 | 427-D-19A

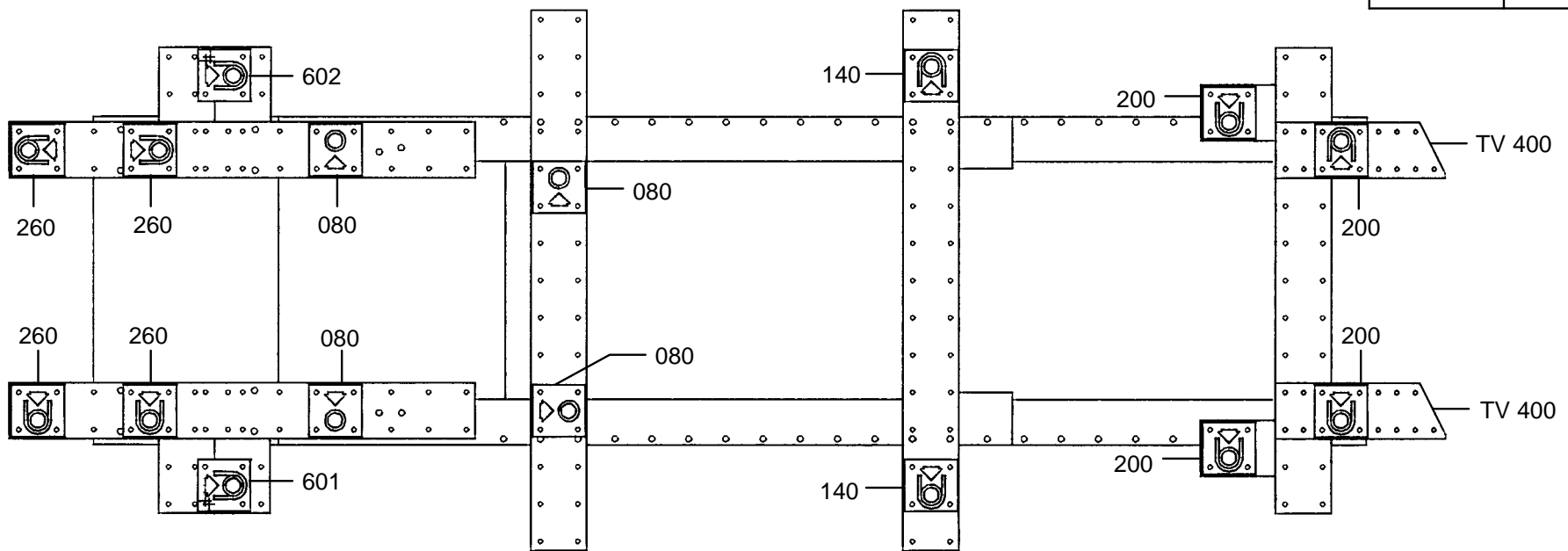

1 2 3 4 5 6 7 8 9 10 11 12 13 14 15 16 17 18 19 20 21 22 23 24 25 26 27 28 29 30 31 32 33 34 35 36

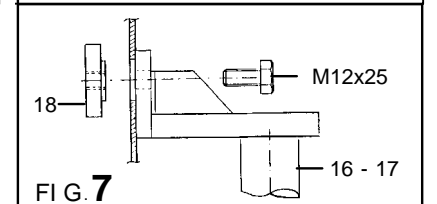
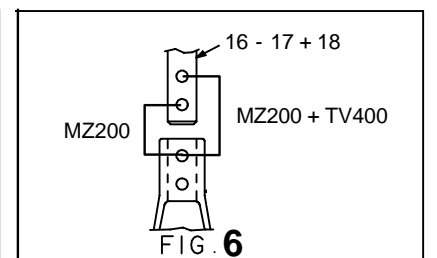
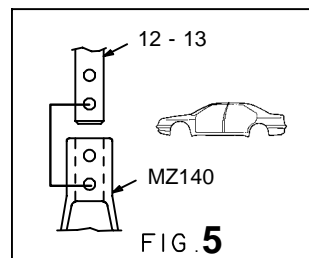
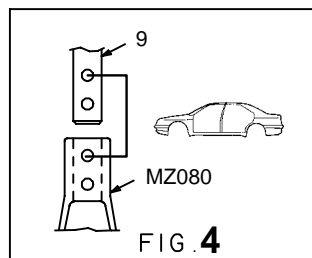
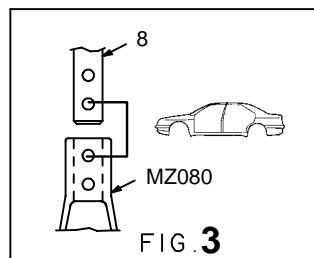
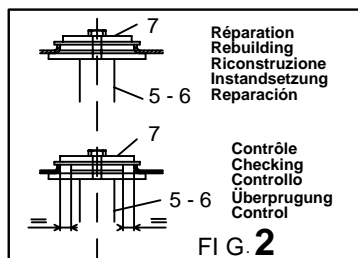
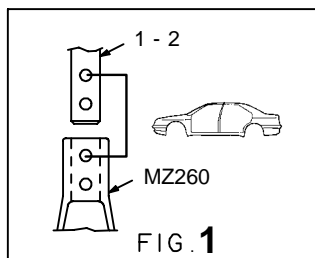

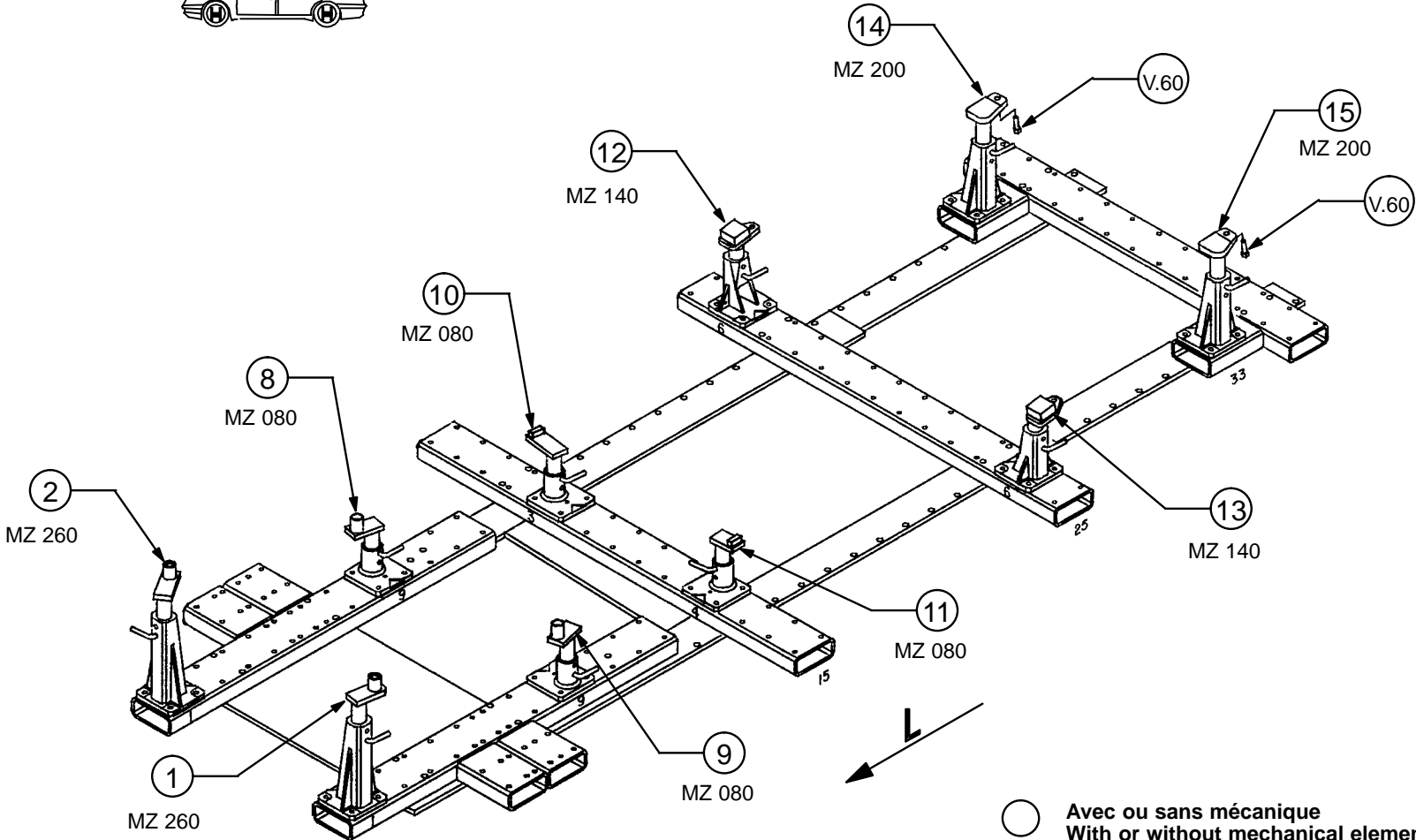

REP.	REFERENCE	PDS	NB	MZ
1	595.701	2,3	1	260
2	595.702	2,2	1	260
3	595.703	2,7	1	260
4	595.704	2,7	1	260
5	595.705	2,1	1	601
6	595.706	2,1	1	602
7	595.707	0,3	2	
8	595.708	2,1	1	080
9	595.709	2,4	1	080
10	595.710	1,9	1	080
11	595.711	1,7	1	080
12	595.712	2,5	1	140
13	595.713	2,5	1	140
14	595.714	2,4	1	200
15	595.715	2,0	1	200
16	595.716	3,2	1	200
17	595.717	3,2	1	200
18	595.718	0,1	2	
	V.67	0,1	1	
	V.60	0,1	2	

	M8x30 M10x70 M12x25 M12x120	1 2 4 1
	M12x80 M12x140	2 2

RENAULT

595.300

39 Kg | 19.04.90 | 427-D-19B

