

REP.	REFERENCE	PDS	NB	MZ
39	564.739	2,1	1	080/140
40	564.740	0,1	2	1
41	564.741	2,1	1	080
42	564.742	2,1	1	080
43	564.743	1,1	2	2
44	564.744	2,3	1	260
45	564.745	2,3	1	260
46	564.746	0,3	2	2
47	564.747	2,9	1	200
48	564.748	2,9	1	200
49	564.749	1,1	2	2
50	564.750	3,6	1	260
51	564.751	3,6	1	260
52	564.752	0,9	2	2
	V.72	0,1	2	

	M 8x16	8
	M 8x45	8
	M 10x110 M 12.150x150	4
	M 12	2

complément au
complementary set to
complemento al
zusatz zu

564.320

PORSCHE

564.307

32 Kg | 09.07.93 | 425-D-4K

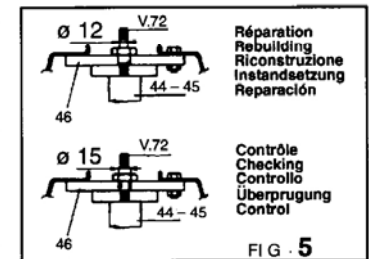
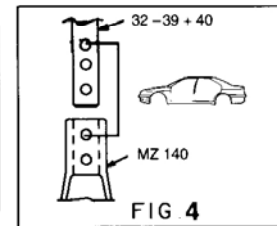
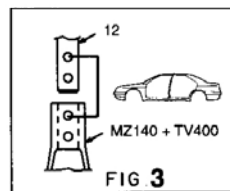
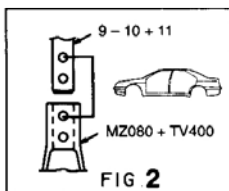
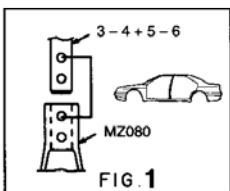
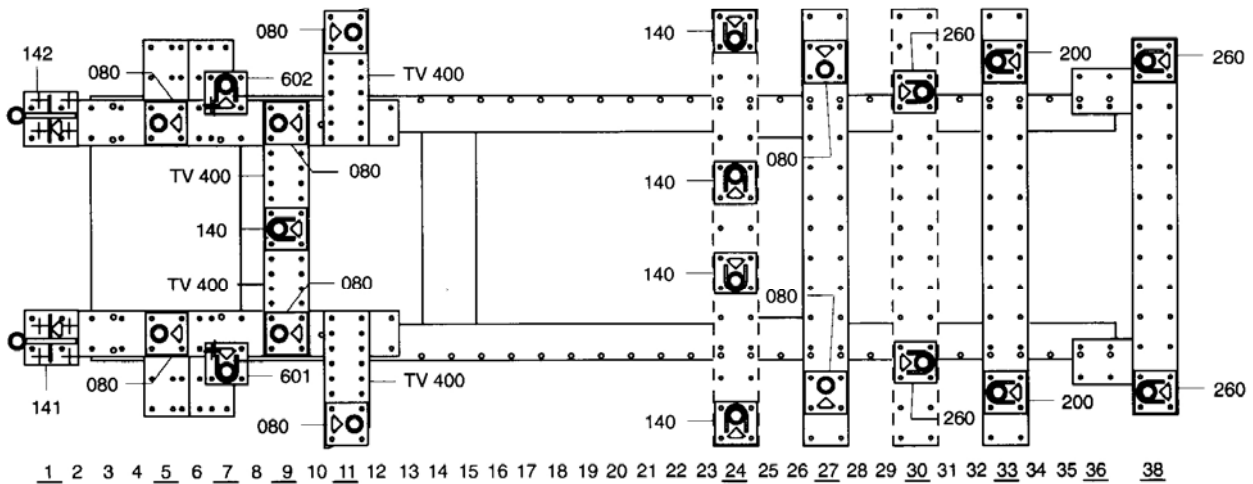

Réparation
Rebuilding
Ricostruzione
Instandsetzung
Reparación

Contrôle
Checking
Controllo
Überprüfung
Control

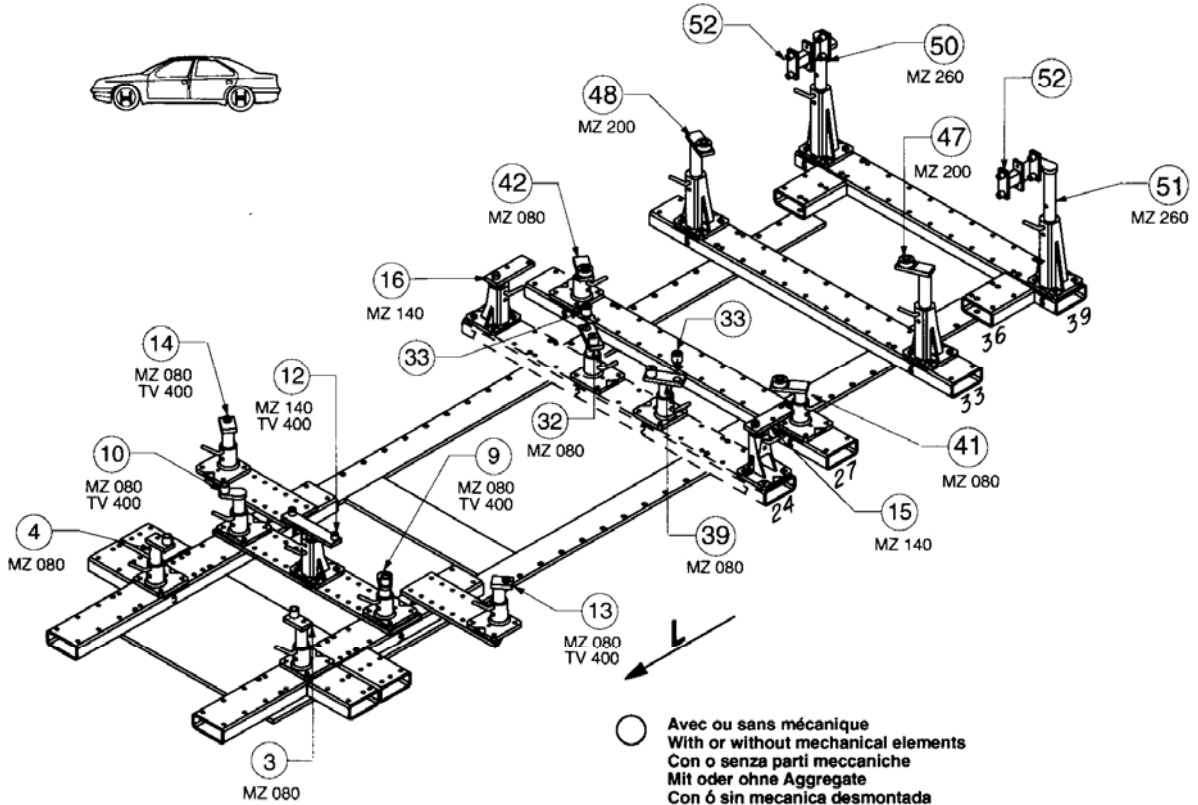

PORSCHE

564.307

32 Kg | 09.07.93 | 425-D-4L

