

REP.	REFERENCE	PDS	NB	PISTON	MZ
1	2531.5001	0,8	1	P220	200
2	2531.5002	0,8	1	P220	200
3	2531.5003	1,4	1	P100	140
4	2531.5004	1,4	1	P100	140
5	2531.5005	0,05	8		
6	2531.5006	1,5	1	P310	260
7	2531.5007	1,5	1	P310	260
8	2531.5008	0,2	2		
9	2531.5009	1,5	1	P100	140
10	2531.5010	1,5	1	P100	140
11	2531.5011	1,5	1	P160	142
12	2531.5012	1,5	1	P160	141
13	2531.5013	0,7	1	P160	080
14	2531.5014	0,7	1	P160	080
15	2531.5015	0,7	1	P100	200
16	2531.5016	0,7	1	P100	200
17	2531.5017	0,1	2		
18	2531.5018	0,8	1	P310/220	260
19	2531.5019	0,8	1	P310/220	260
20	2531.5020	0,3	2		
21	2531.5021	0,7	1	P310	260
22	2531.5022	0,7	1	P310	260
A	MZ2500.CR500B	6,5	1		
B	MR.2531.500	0,2	1		

M 12-35	2
M 14-50	2
M 14-120	4
M 12x1,25-60	2
M 14x1,50-50	2
M 14x1,50-90	2
M 14x1,50-120	2
M 14x1,50-140	2
M 14	6

○ Avec ou sans mécanique  
 With or without mechanical elements  
 Con o senza parti meccaniche  
 Mit oder ohne Aggregate  
 Con ó sin mecánica desmontada

**2531.500**

30 Kg	18.07.2008	410-D-77A
2531.500-RVA3-1		00



**NISSAN**

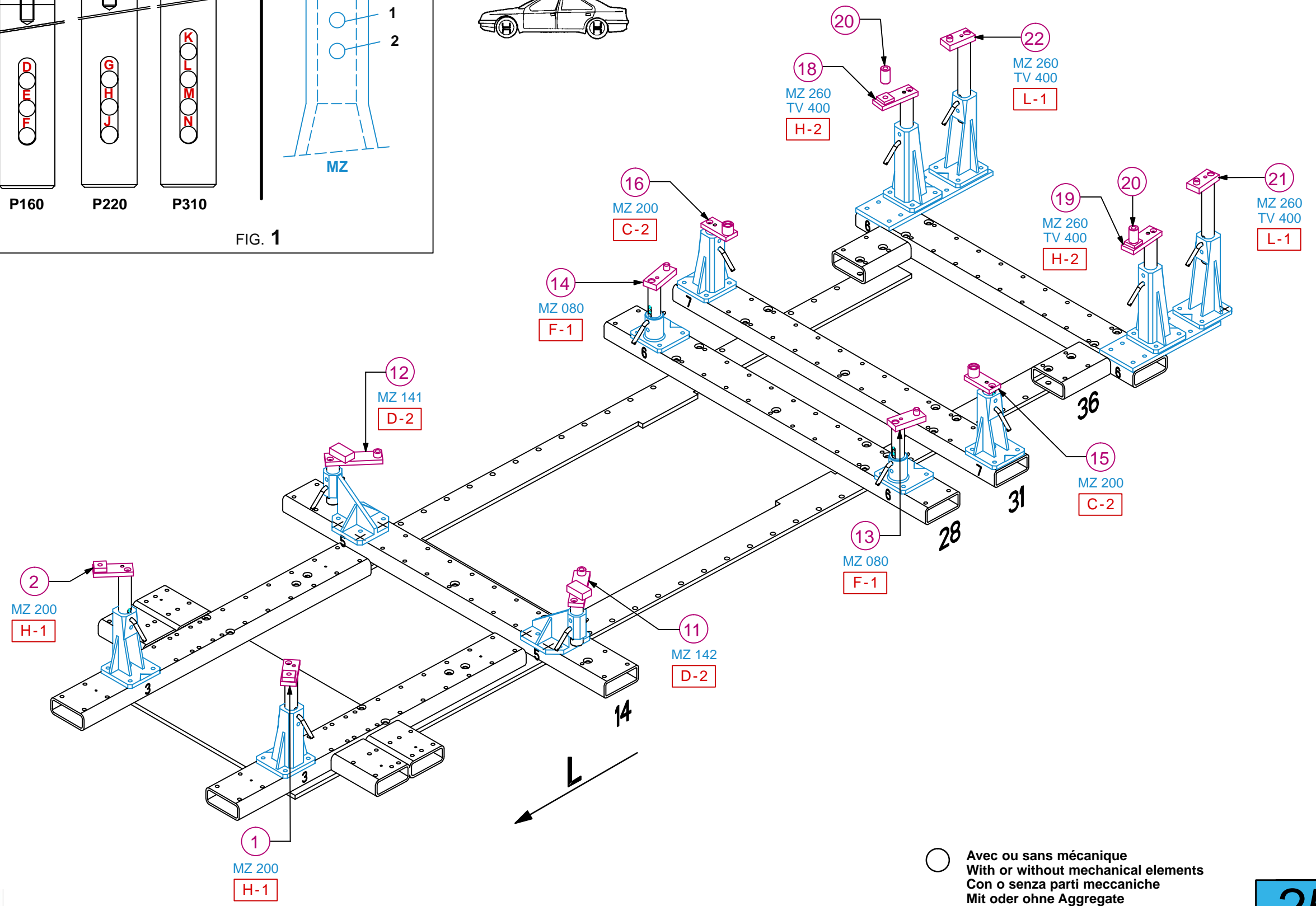
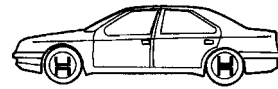
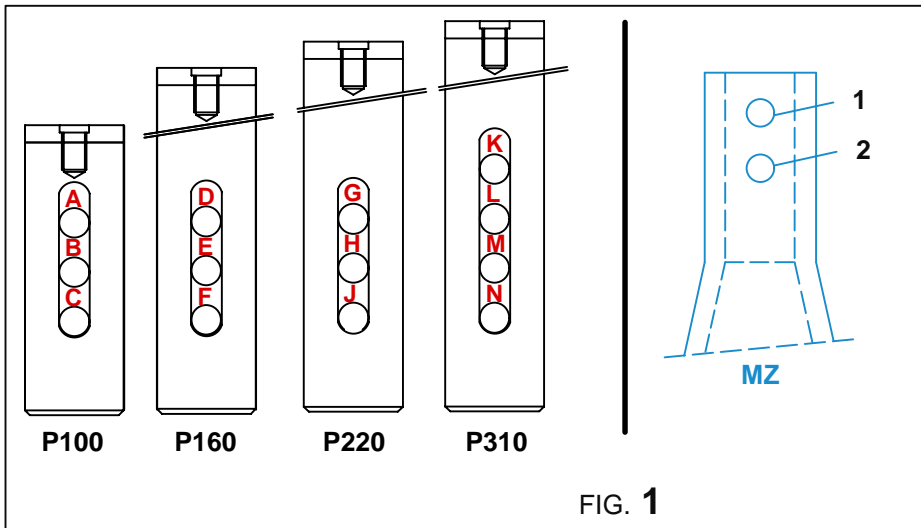

○ Avec ou sans mécanique  
 With or without mechanical elements  
 Con o senza parti meccaniche  
 Mit oder ohne Aggregate  
 Con ó sin mecánica desmontada



<b>2531.500</b>		
30 Kg	18.07.2008	410-D-77B
2531.500-RVA3-1		00

**NISSAN**

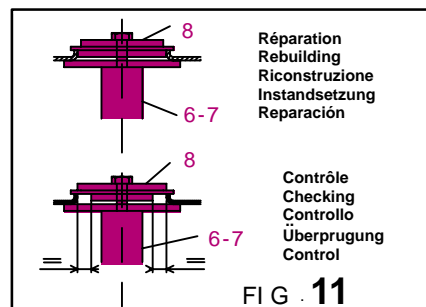
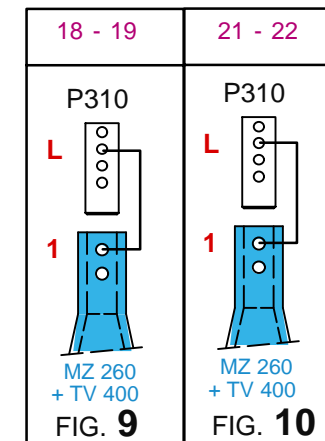
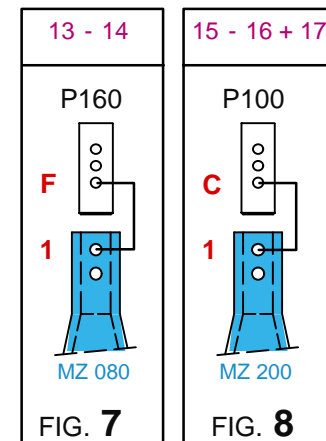
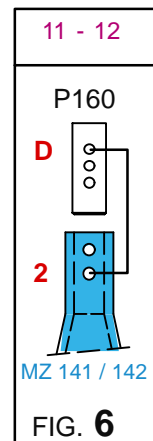
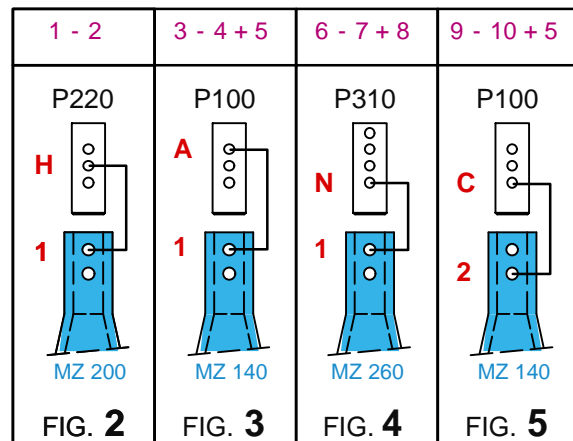
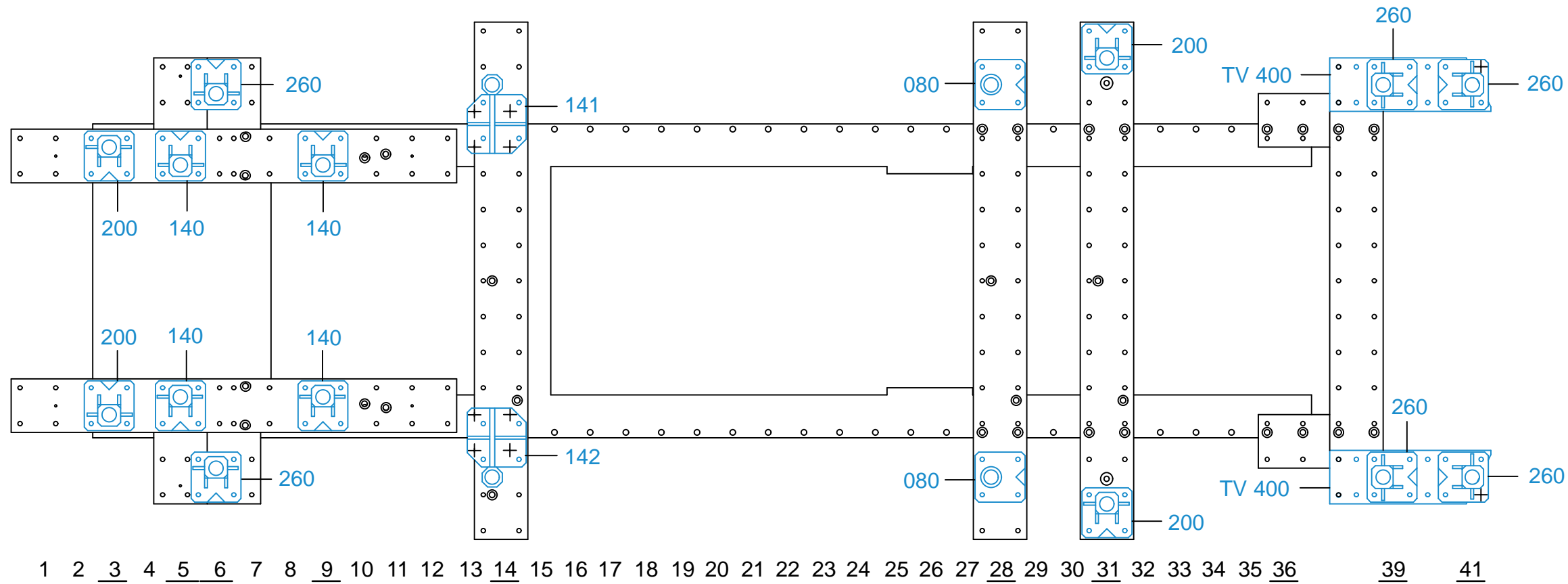

○ Avec ou sans mécanique  
With or without mechanical elements  
Con o senza parti meccaniche  
Mit oder ohne Aggregate  
Con ó sin mecánica desmontada

**NISSAN**

<b>2531.500</b>		
30 Kg	18.07.2008	410-D-77C
2531.500-RVA3-2		00

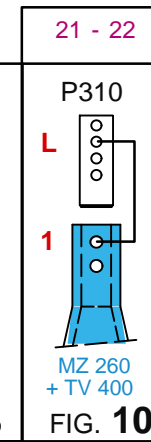
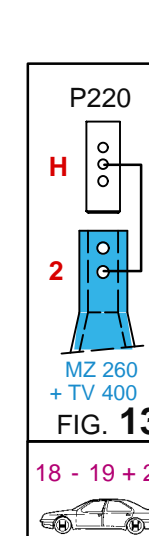
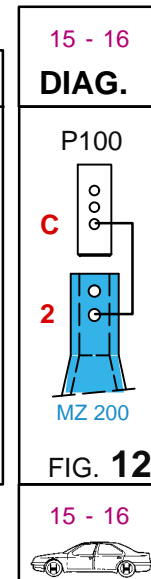
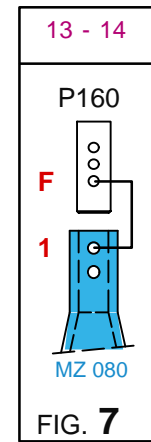
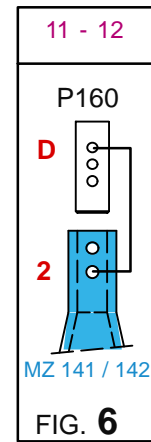
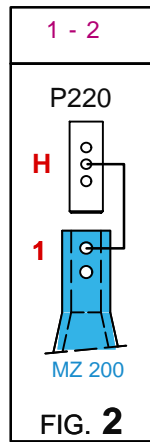
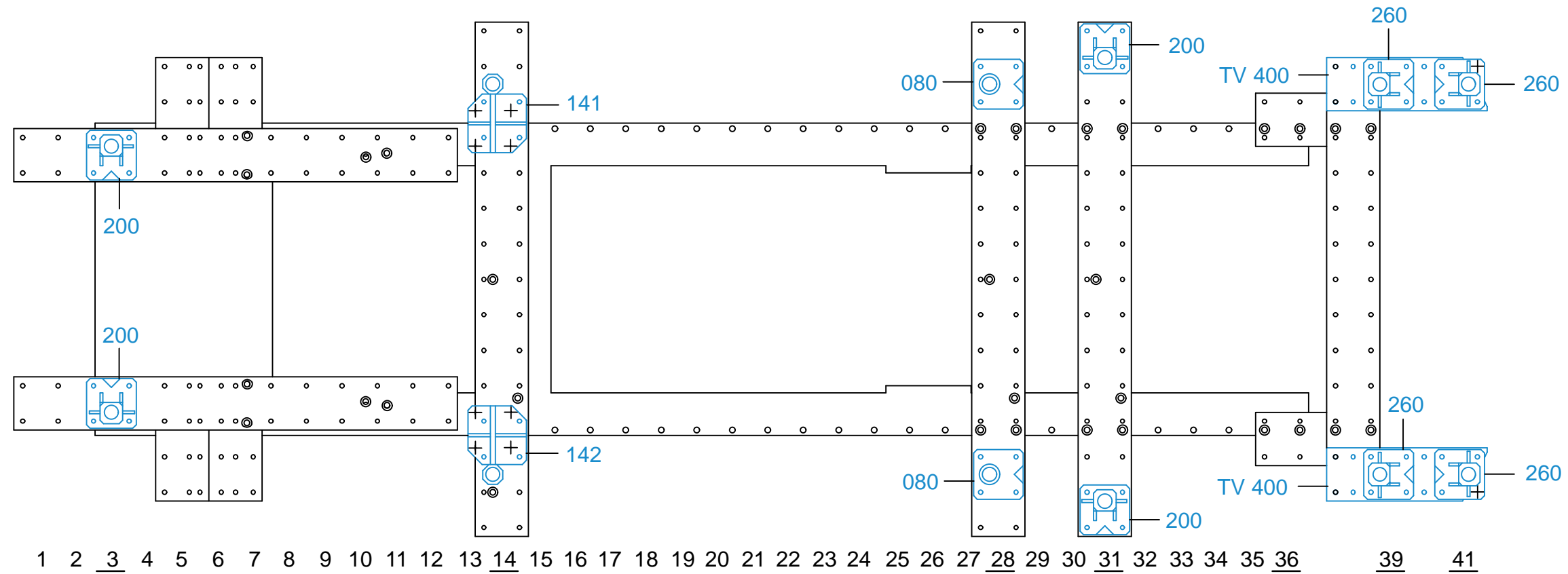
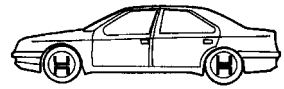

**NISSAN**

○ Avec ou sans mécanique  
With or without mechanical elements  
Con o senza parti meccaniche  
Mit oder ohne Aggregate  
Con ó sin mecanica desmontada

<b>2531.500</b>		
30 Kg	18.07.2008	410-D-77D
2531.500-RVA3-2		00