

REP.	REFERENCE	PDS	NB	PISTON	MZ
1	2505.5001	2,4	1	P220	260
2	2505.5002	2,4	1	P220	260
3	2505.5003	3,4	1		
4	2505.5004	3,4	1		
5	2505.5005	0,2	2		
6	2505.5006	2,4	1	P160	602
7	2505.5007	1,2	1	P160	260
8	2505.5008	0,7	1	P310	602
9	2505.5009	0,7	1	P310	601
10	2505.5010	0,2	2		
11	2505.5011	0,9	1	P160	260
12	2505.5012	0,9	1	P160	260
13	2505.5013	0,9	1	P100	140/080
14	2505.5014	0,9	1	P100	140/080
15	2505.5015	0,2	2		
16	2505.5016	0,8	1	P100	080
17	2505.5017	0,8	1	P100	080
18	2505.5018	0,7	1	P100	080
19	2505.5019	0,7	1	P100	080
20	2505.5020	3,4	1	P100	080
21	2505.5021	3,4	1	P100	080
22	2505.5022	0,6	2		
23	2505.5023	1,2	1	P310	260
24	2505.5024	1,2	1	P310	260
25	2505.5025	1,7	1	P220	200
26	2505.5026	1,7	1	P220	200
27	2505.5027	0,5	1		
28	2505.5028	0,5	1		
29	2505.5029	1,5	1	P160	200
30	2505.5030	1,5	1	P160	200
31	MZ2500.CR570B	11,6	1		
32	MR.2505.500	0,2	1		

M 8-25	8
M 10-50	2
M 10-60	2
M 12-25	6
M 12-30	5
M 12-90	2
M 14-20	2
M 14-80	2
M 18-30	2
M 14x1,50-60	2
M 14x1,50-100	2
M 14x1,50-150	2
M 8	2
M 14	2
M 18	2

○ Avec ou sans mécanique
With or without mechanical elements
Con o senza parti meccaniche
Mit oder ohne Aggregate
Con ó sin mecanica desmontada

RENAULT

2505.500

56 Kg	11.07.2007	427-D-34A
2505.500-RVA3-1		00



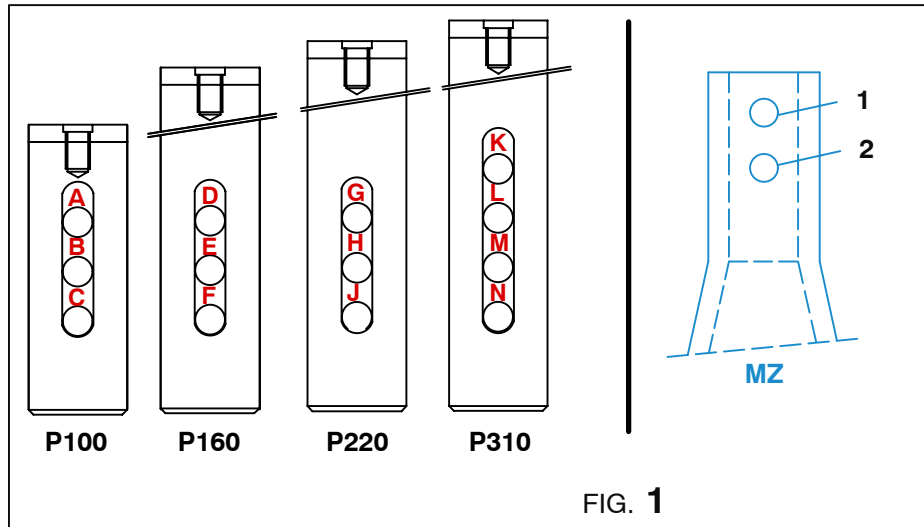
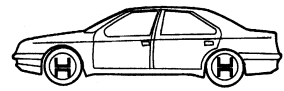
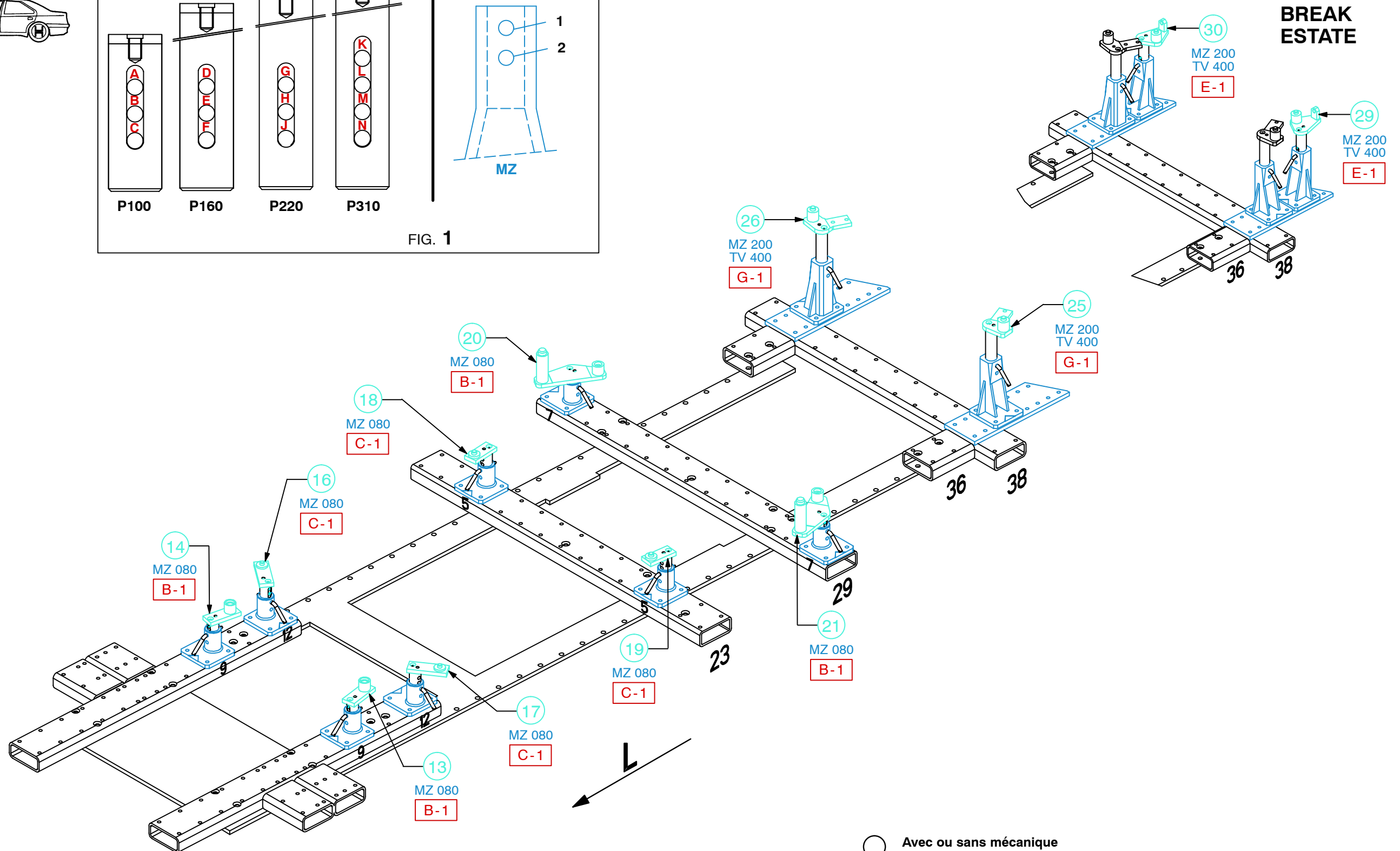

FIG. 1



○ Avec ou sans mécanique
 With or without mechanical elements
 Con o senza parti meccaniche
 Mit oder ohne Aggregate
 Con ó sin mecanica desmontada



RENAULT

2505.500		
56 Kg	11.07.2007	427-D-34B
2505.500-RVA3-1		00

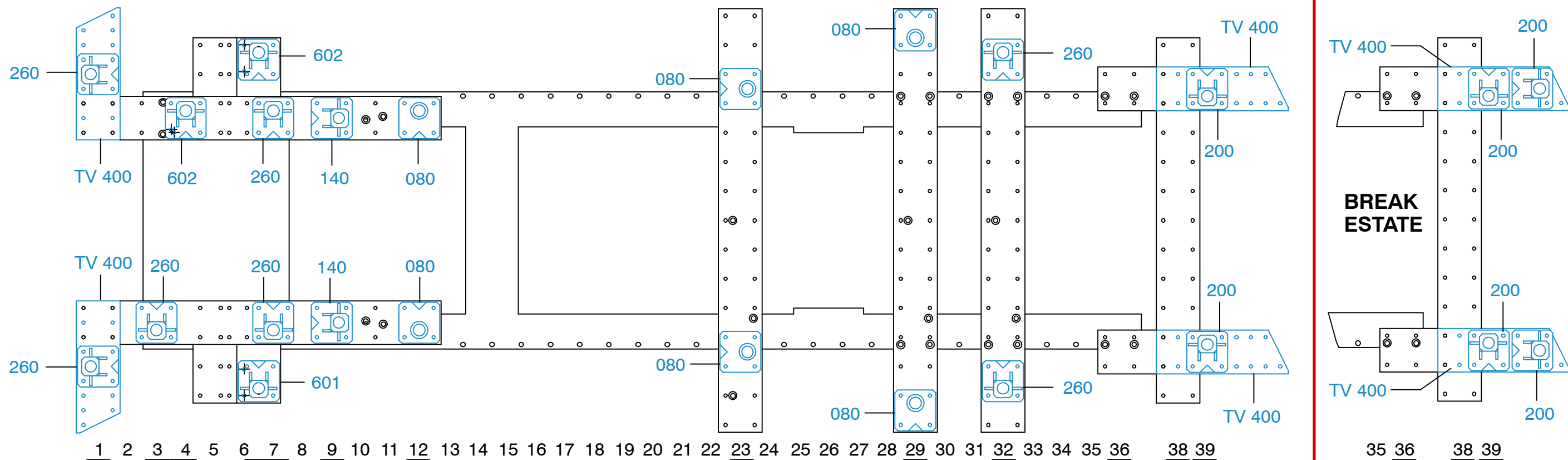

1 - 2 + 5	6	7	8 - 9 + 10	11 - 12	13 - 14 + 15	16 - 17
P220 H	P160 E	P160 F	P310 K	P160 F	P100 B	P100 C
2	1	1	1	2	1	1
MZ 260 + TV 400	MZ 602	MZ 260	MZ 601 / 602	MZ 260	MZ 140	MZ 080
FIG. 2	FIG. 3	FIG. 4	FIG. 5	FIG. 6	FIG. 7	FIG. 8

18 - 19
P100 C
1
MZ 080
FIG. 9

20 - 21 + 22	23 - 24
P100 B	P310 N
1	1
MZ 080	MZ 260
FIG. 10	FIG. 11

25 - 26	
P220 G	P220 J
1	2
MZ 200 + TV 400	MZ 200 + C05
Ou/Or/ Oder/O	
FIG. 12	

29 - 30
P160 E
1
MZ 200 + TV 400
FIG. 13

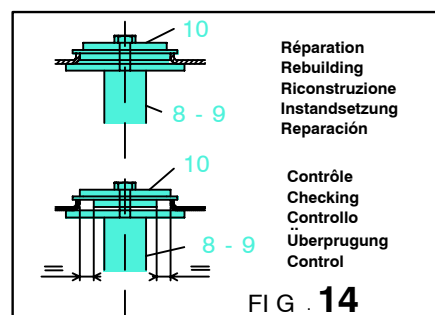
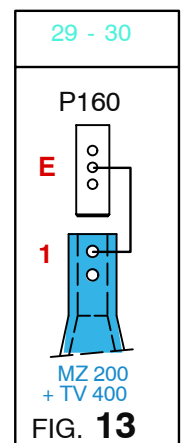
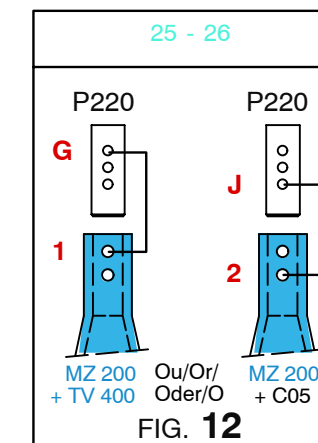
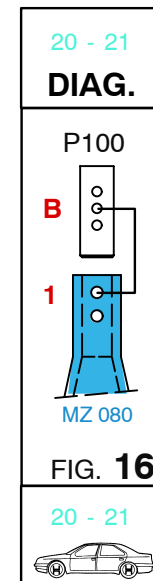
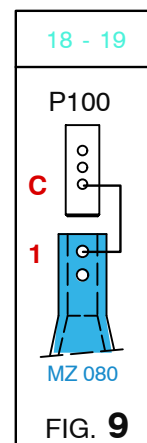
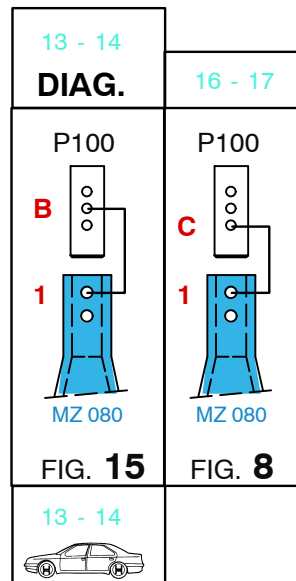
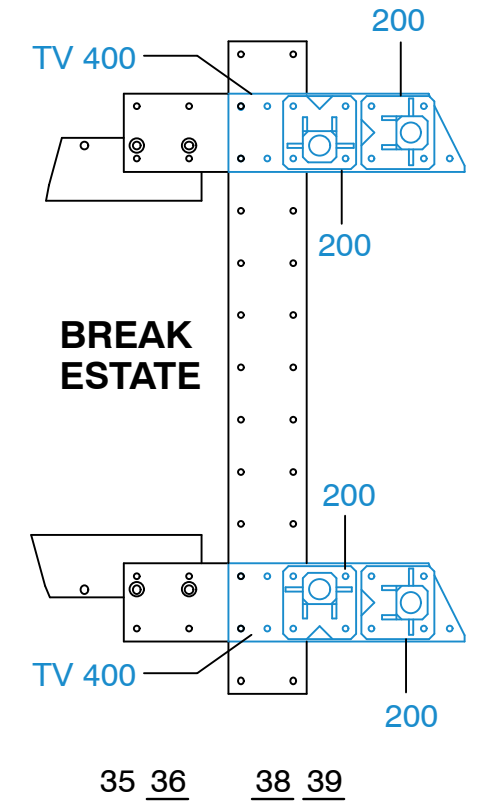
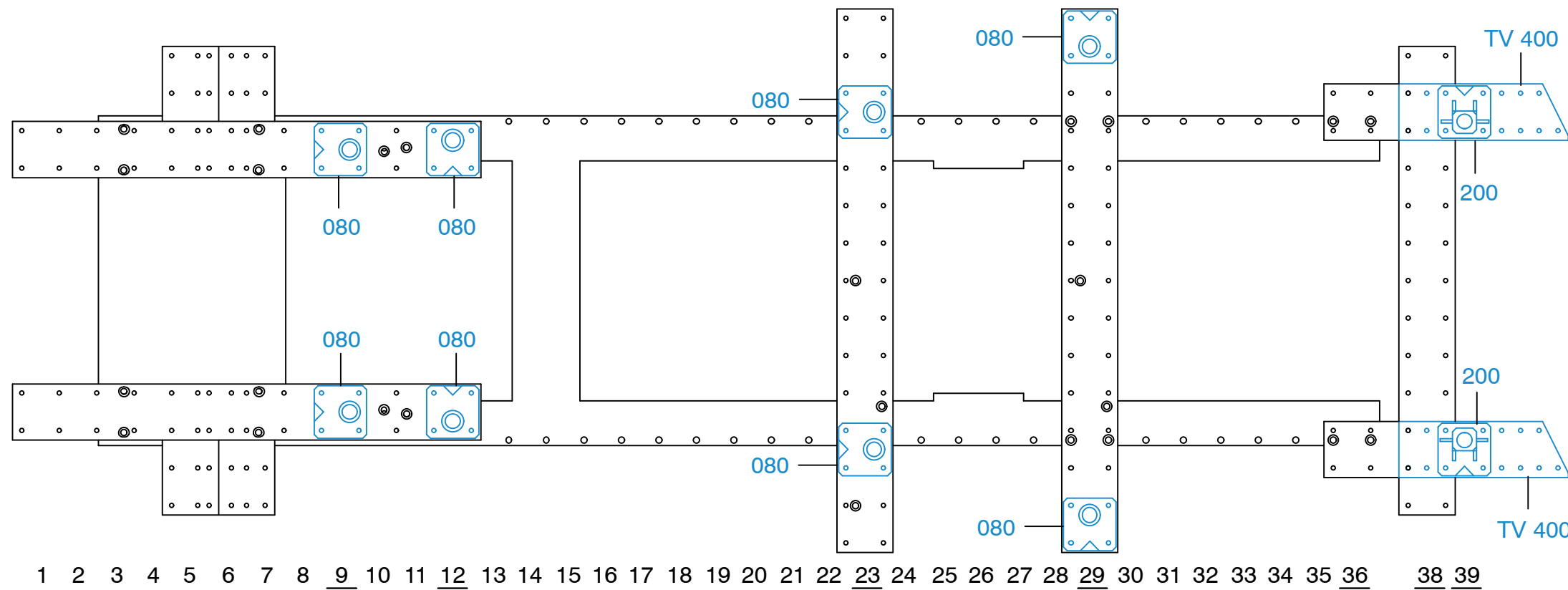
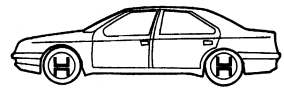

FIG. 14

○ Avec ou sans mécanique
With or without mechanical elements
Con o senza parti meccaniche
Mit oder ohne Aggregate
Con ó sin mecanica desmontada

RENAULT

2505.500		
56 Kg	11.07.2007	427-D-34C
2505.500-RVA3-2		00



○ Avec ou sans mécanique
With or without mechanical elements
Con o senza parti meccaniche
Mit oder ohne Aggregate
Con ó sin mecanica desmontada

RENAULT

2505.500

56 Kg | 11.07.2007 | 427-D-34D
2505.500-RVA3-2 | 00

