

Avec ou sans mécanique
With or without mechanical elements
Con o senza parti meccaniche
Mit oder ohne Aggregate
Con ó sin mecanica desmontada

PEUGEOT

REP.	REFERENCE	PDS	NB	MZ
45	2062.7045	1,4	1	080
46	2062.7046	1,4	1	080
47	2062.7047	2,6	1	601
48	2062.7048	2,6	1	602
49	2062.7049	2,1	1	601

M 6-20	2
M 12-110	2

complément au
complementary set to
complemento al
zusatz zu

**2062.300 +
2062.309
Ou/Or/Oder/O
2089.300**

2089.309
11 Kg
30.01.2007
423-D-25D

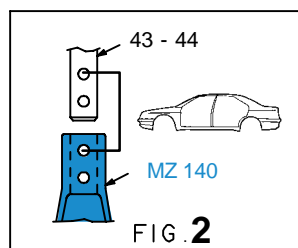
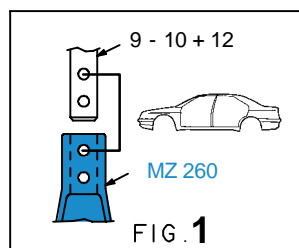
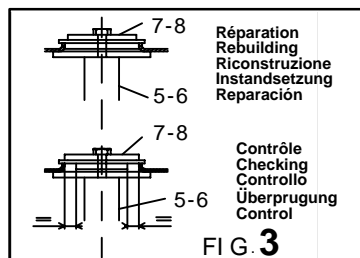
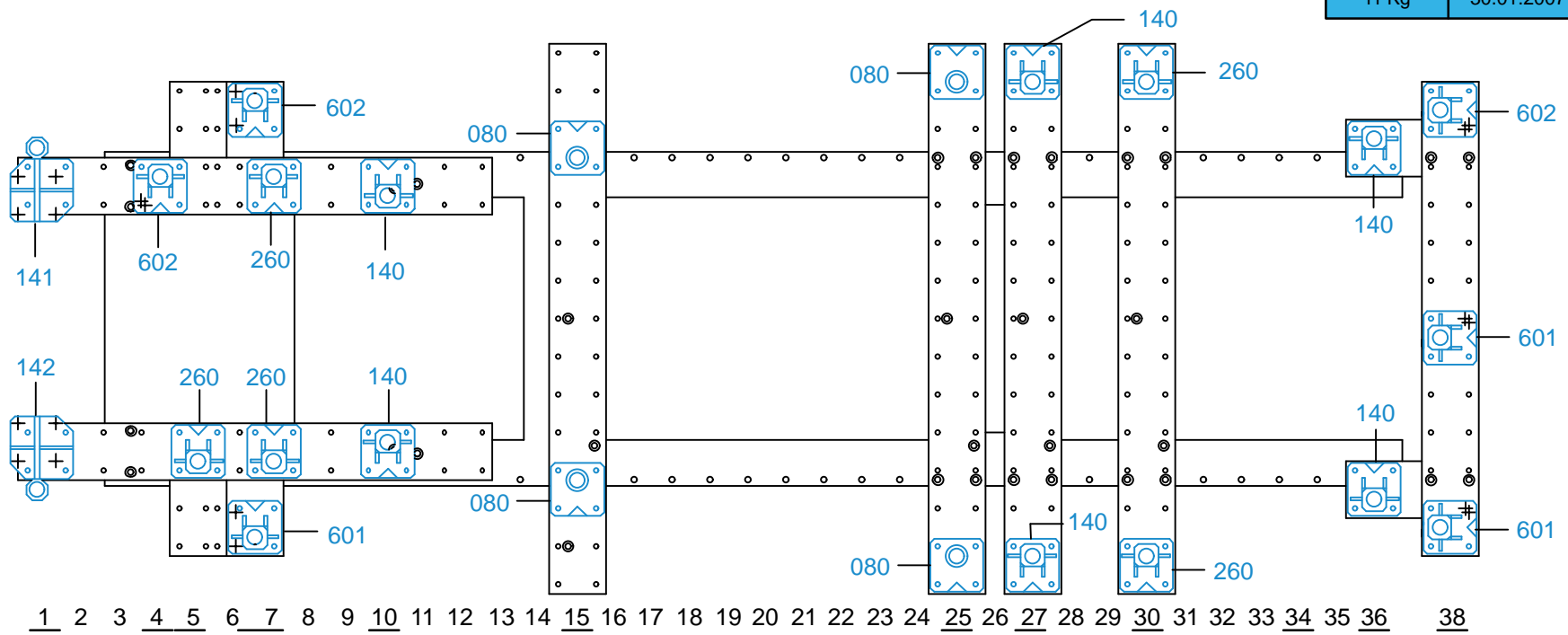

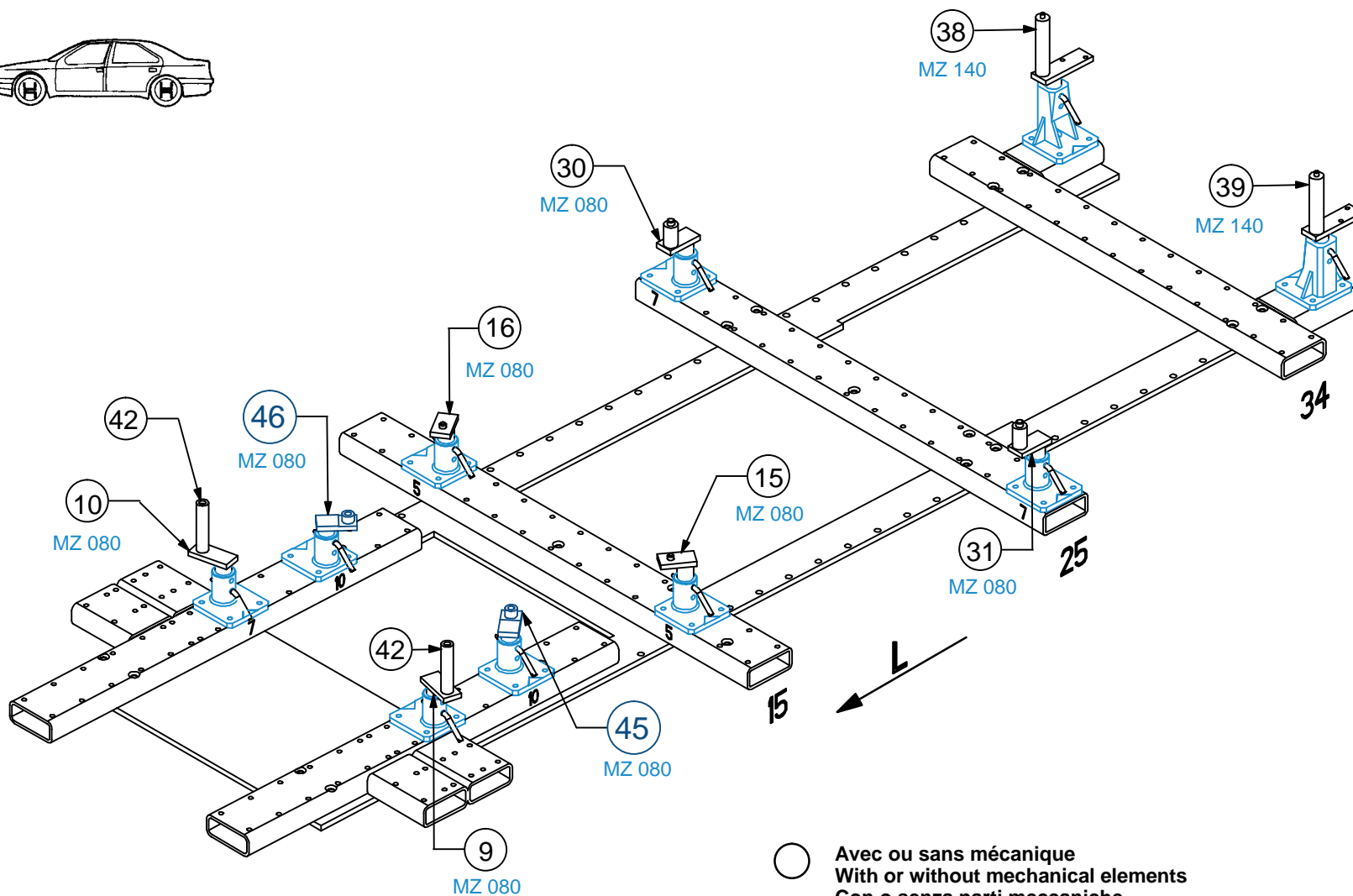
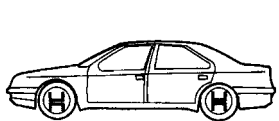

○ Avec ou sans mécanique
 With or without mechanical elements
 Con o senza parti meccaniche
 Mit oder ohne Aggregate
 Con ó sin mecánica desmontada

PEUGEOT

2089.309		
11 Kg	30.01.2007	423-D-25E

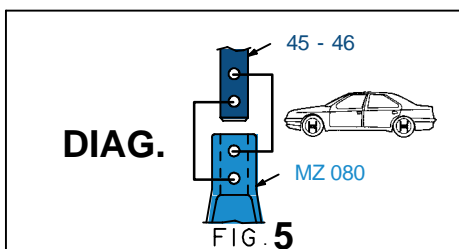
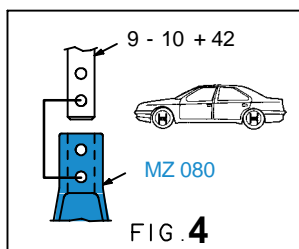
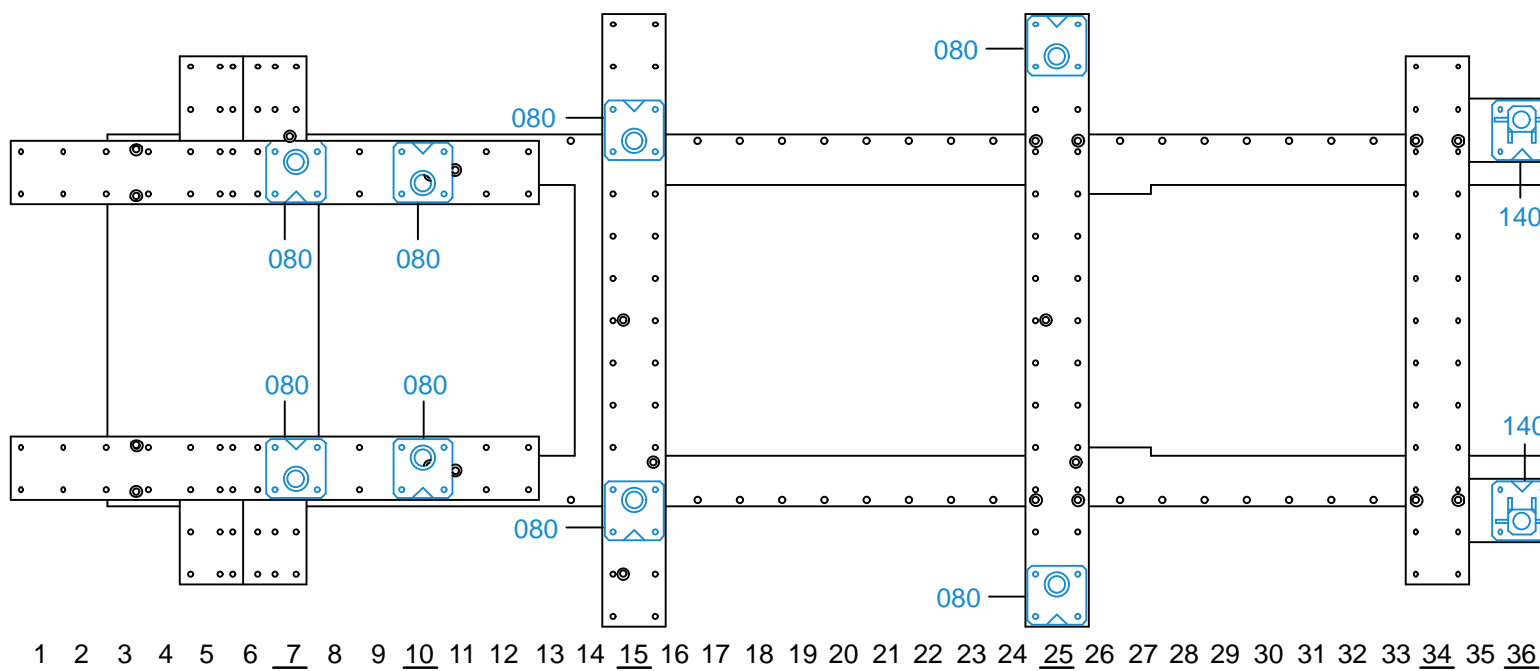

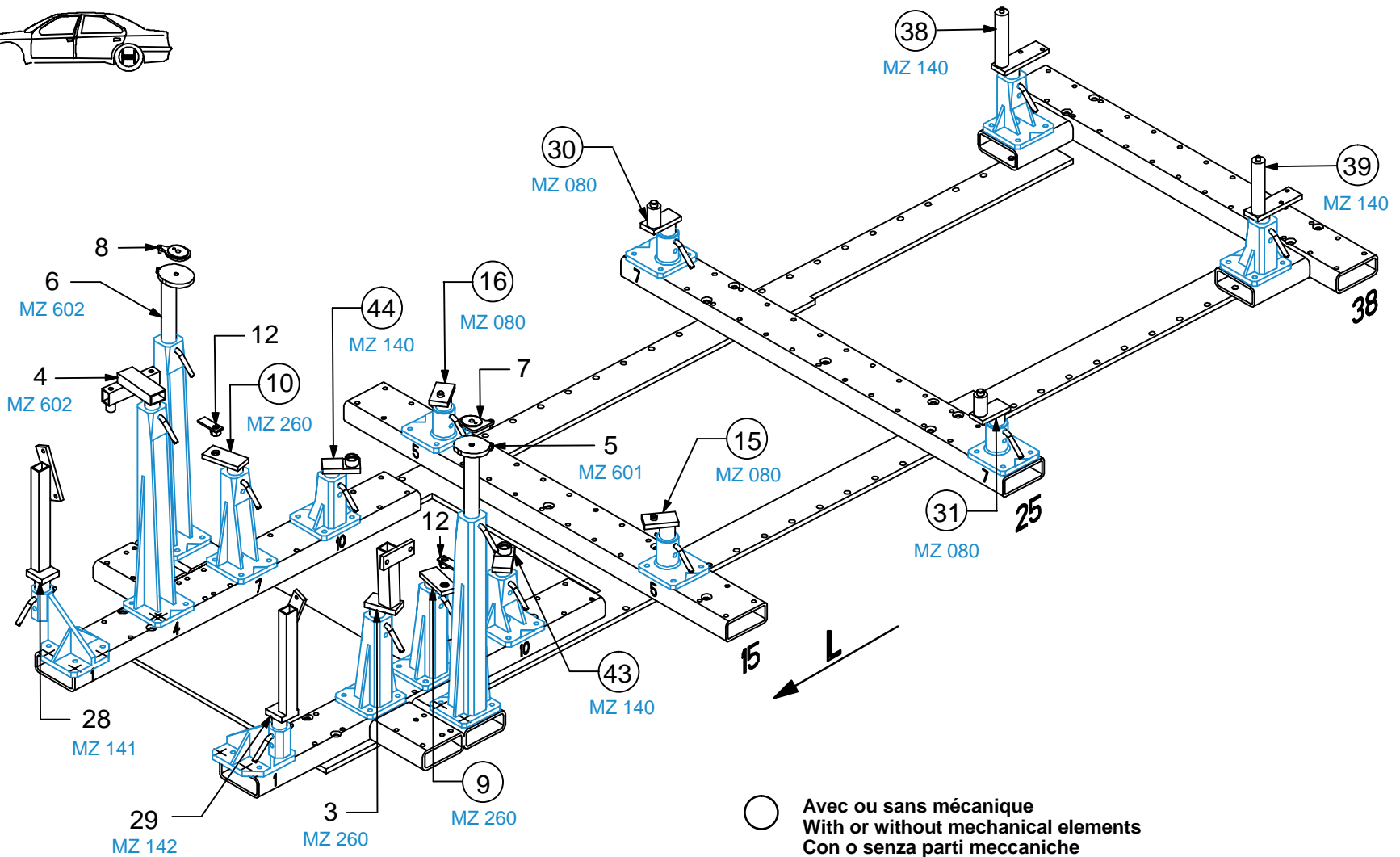
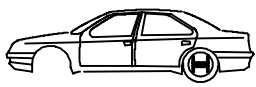

○ Avec ou sans mécanique
 With or without mechanical elements
 Con o senza parti meccaniche
 Mit oder ohne Aggregate
 Con ó sin mecanica desmontada

PEUGEOT

2089.309		
11 Kg	30.01.2007	423-D-25F

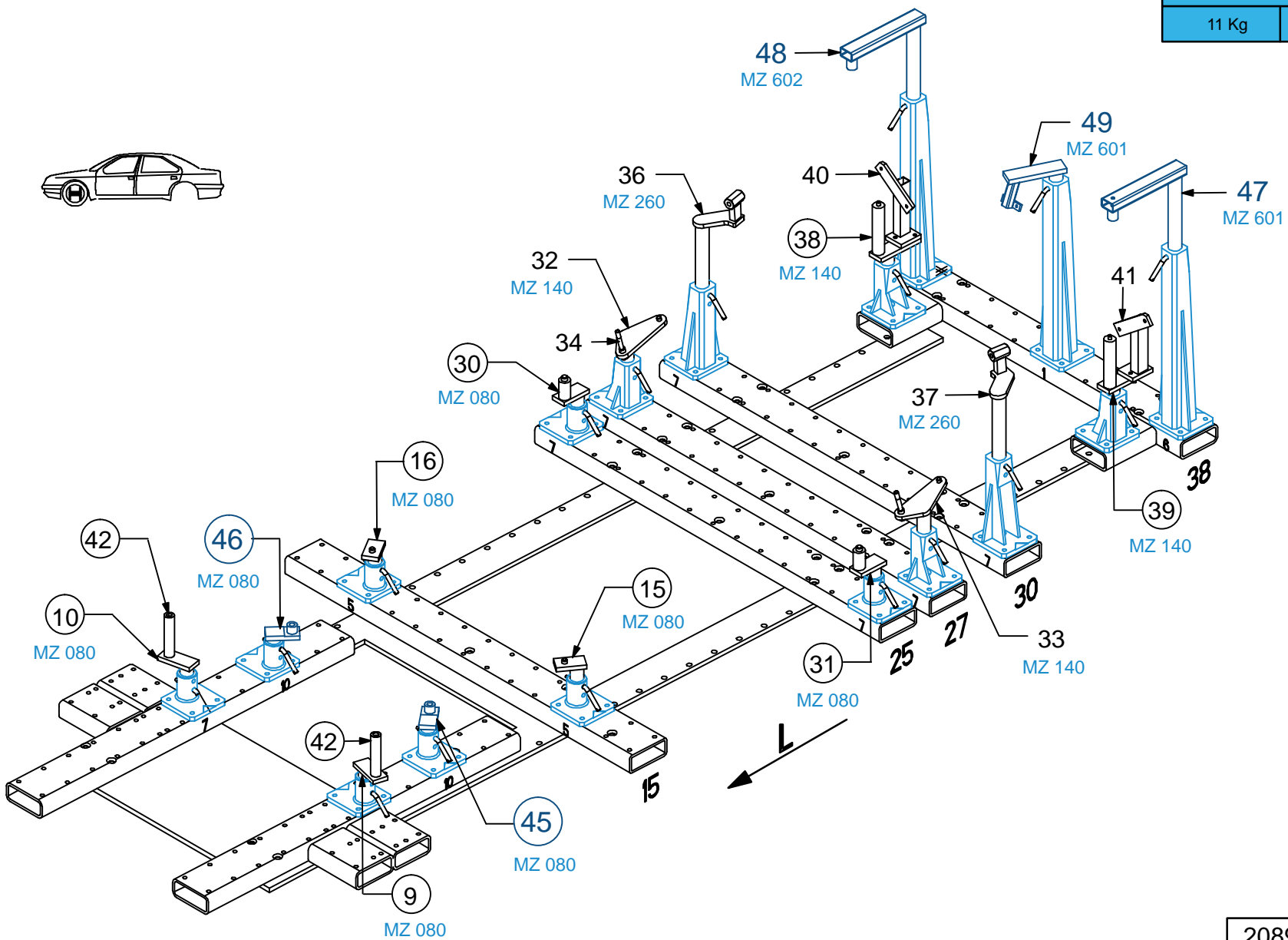

2089.309-RA3-2 | 00