

○ Avec ou sans mécanique
 With or without mechanical elements
 Con o senza parti meccaniche
 Mit oder ohne Aggregate
 Con ó sin mecanica desmontada

PORSCHE

REP.	REFERENCE	PDS	NB	MZ
45	2060.7045	2,6	1	260
46	2060.7046	2,6	1	260
47	2060.7047	0,05	2	

M 8-45
 M 12-25

complément au
 complementary set to
 complemento al
 zusatz zu **2060.300**

2060.309

6 Kg | 13.06.2006 | 425-D-7C

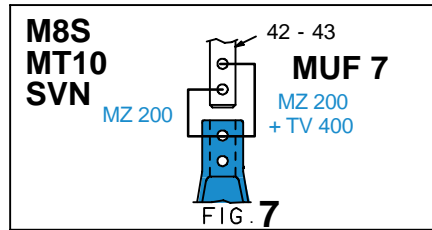
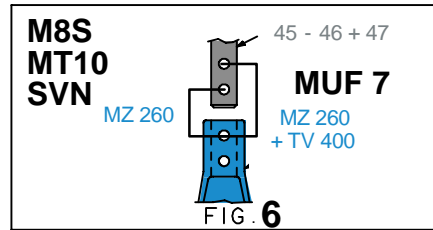
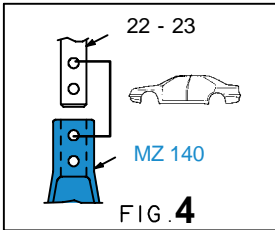
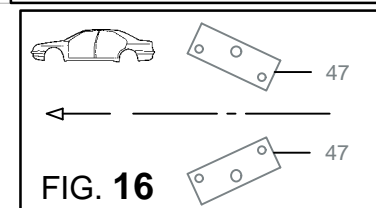
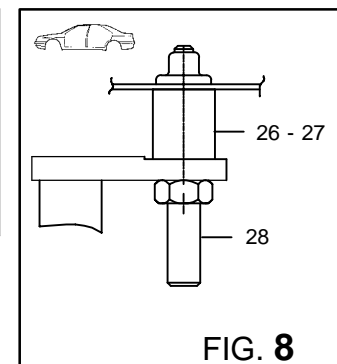
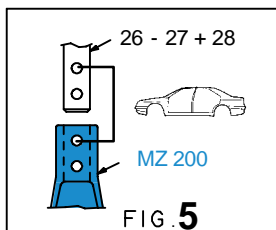
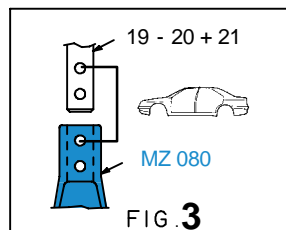
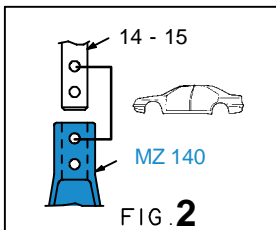
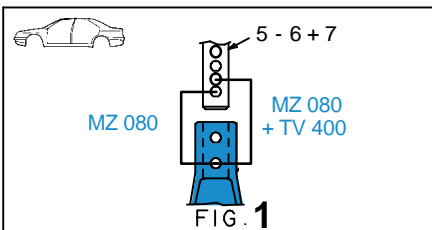
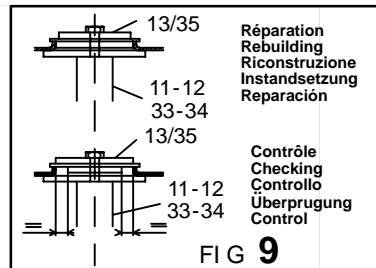
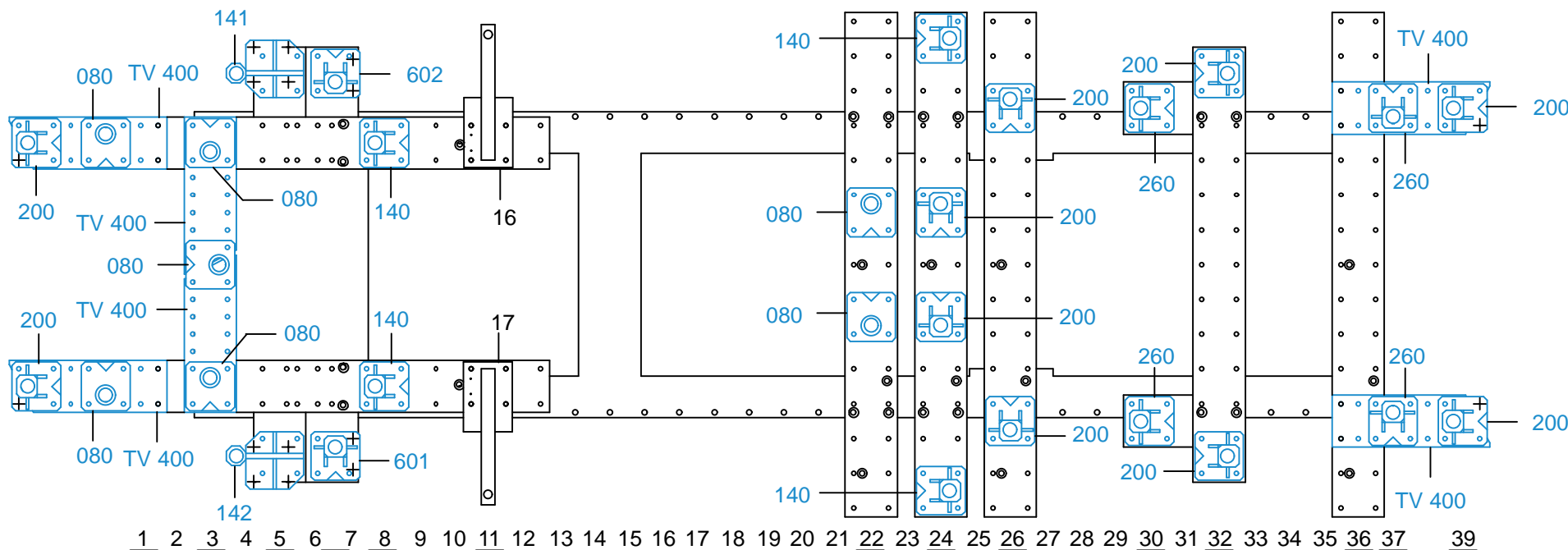

2060.309-RA3-1 | 00