

○ Avec ou sans mécanique
 With or without mechanical elements
 Con o senza parti meccaniche
 Mit oder ohne Aggregate
 Con ó sin mecánica desmontada

REP.	REFERENCE	PDS	NB	MZ
52	2010.7052	2,8	1	
53	2010.7053	2,8	1	
complément au complementary set to complemento al zusatz zu				2035.300 Ou/Or/Oder/O 2010.300 + 2010.309
2035.307				
6 Kg	14.02.2008	431-D-8A		
2035.307-RVA3-1				01

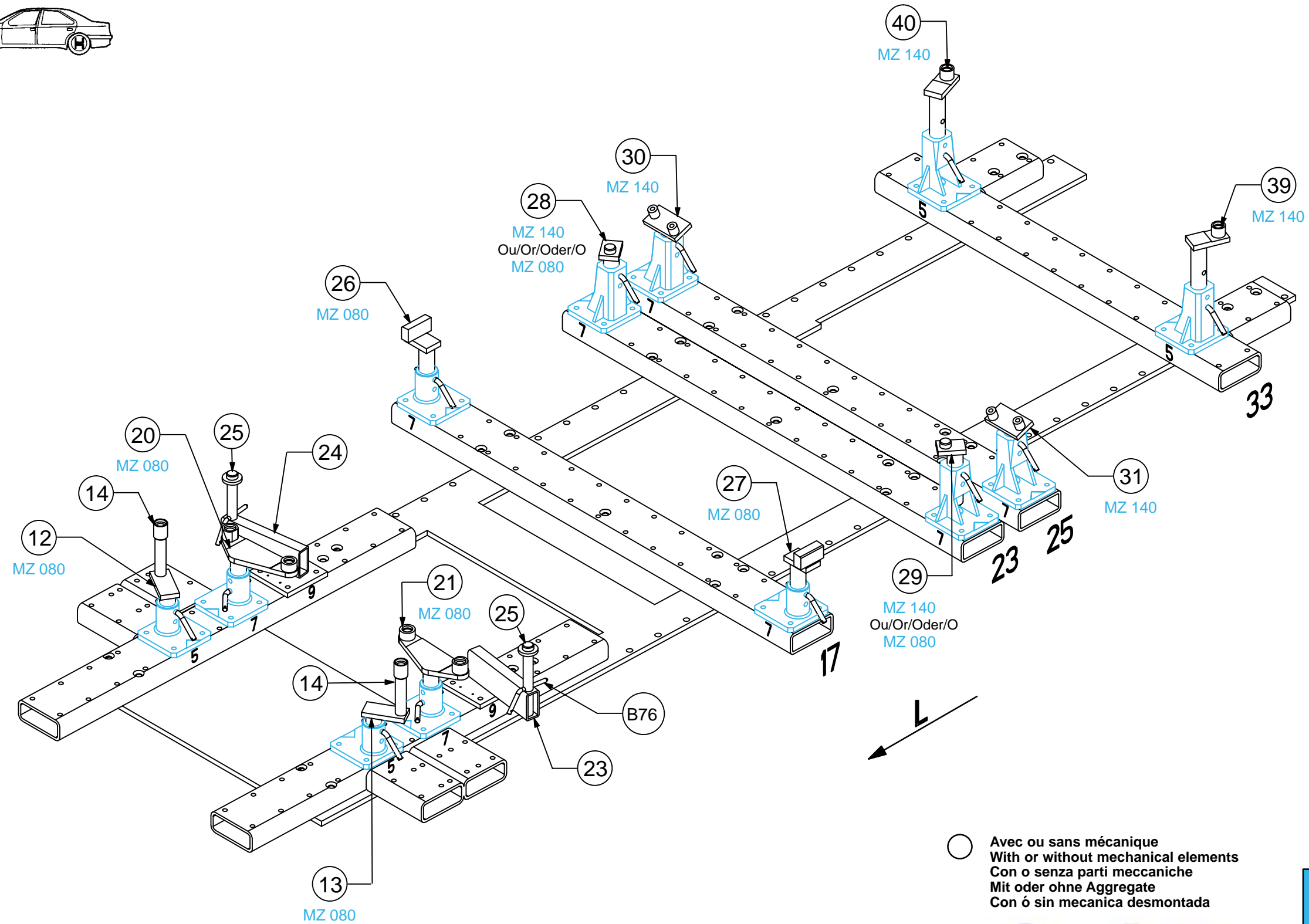
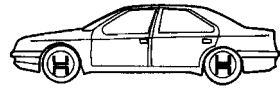

○ Avec ou sans mécanique
With or without mechanical elements
Con o senza parti meccaniche
Mit oder ohne Aggregate
Con ó sin mecanica desmontada

2035.307

6 Kg	14.06.2004	431-D-8B
2035.307 - RVA3 - 1		00

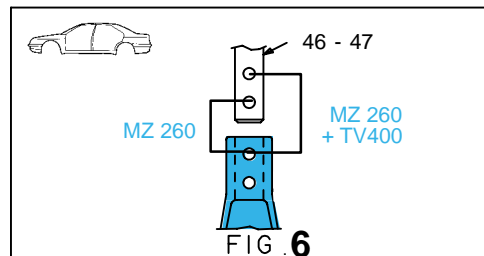
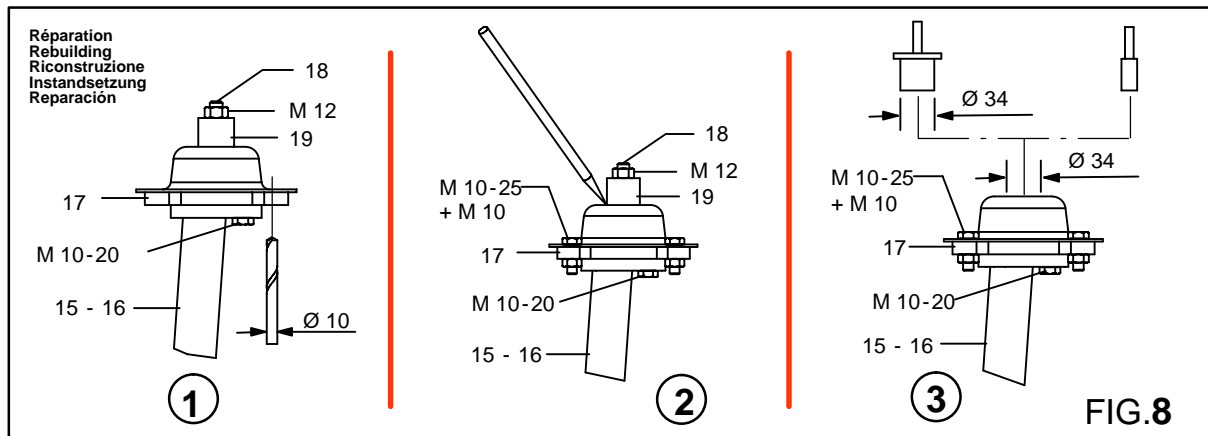
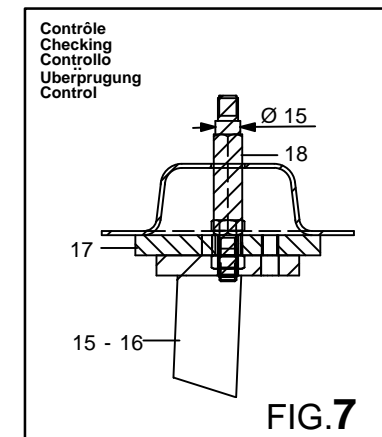
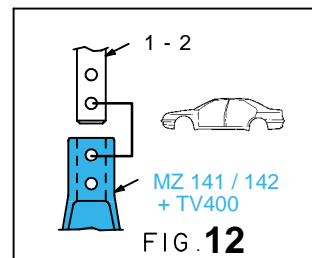
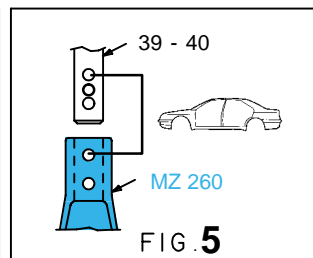
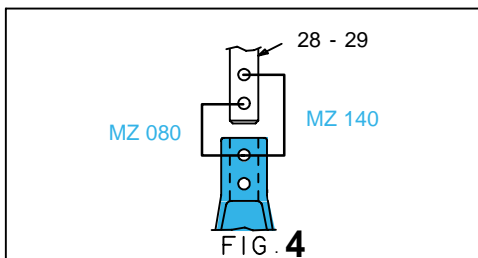
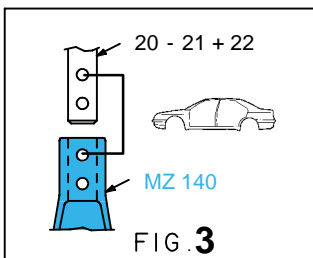
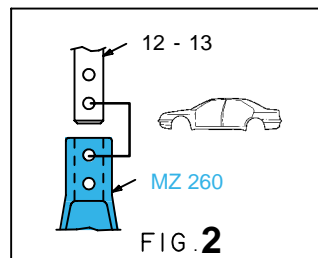
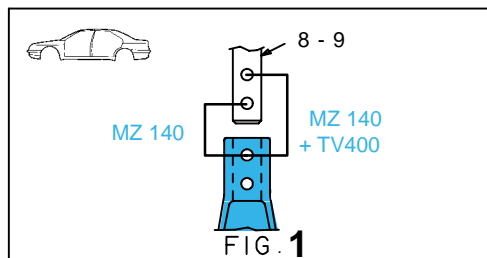
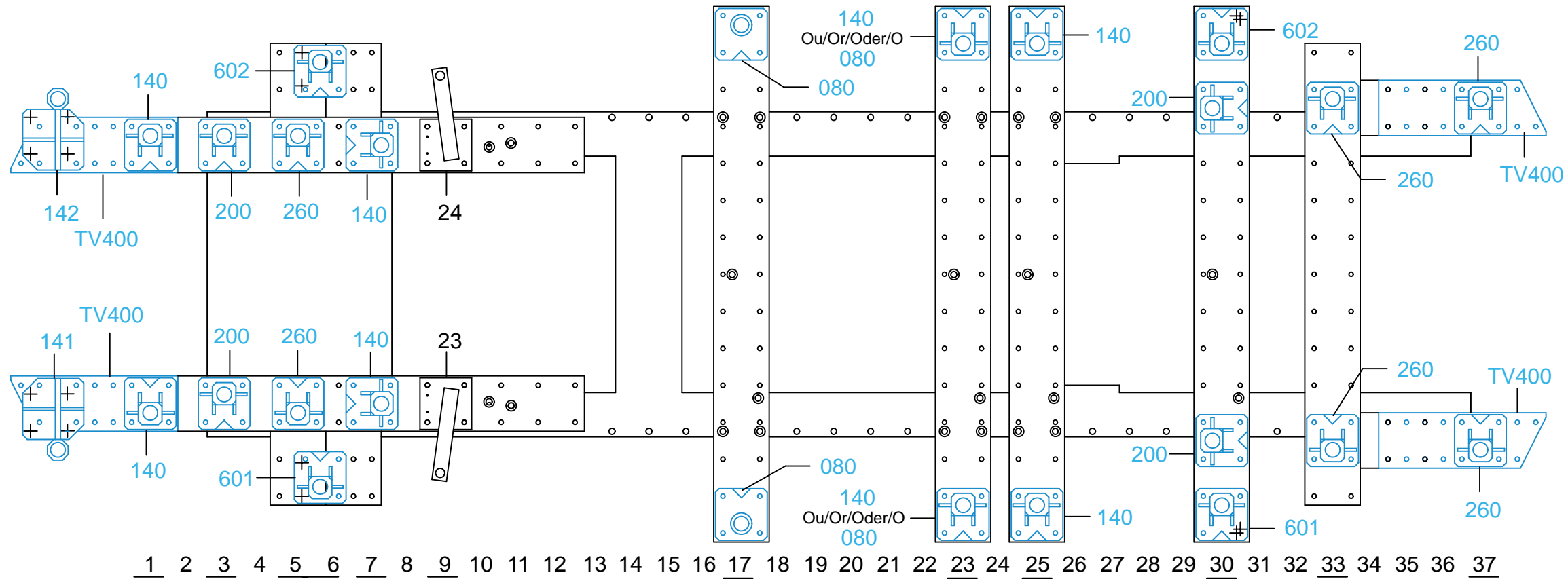
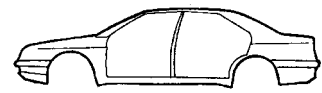

○ Avec ou sans mécanique
 With or without mechanical elements
 Con o senza parti meccaniche
 Mit oder ohne Aggregate
 Con ó sin mecanica desmontada

2035.307

6 Kg | 14.06.2004 | 431-D-8C

2035.307-RVA3-2 | 00



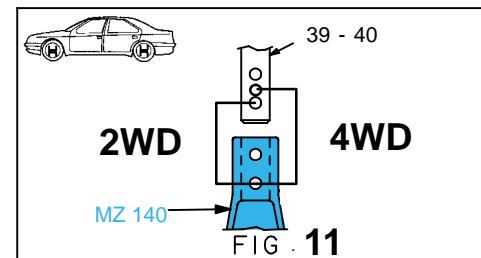
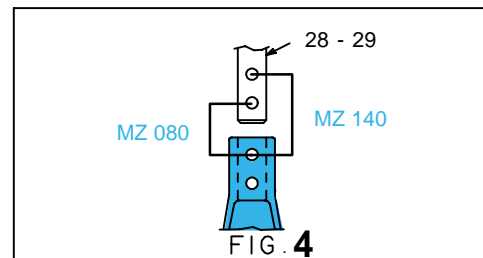
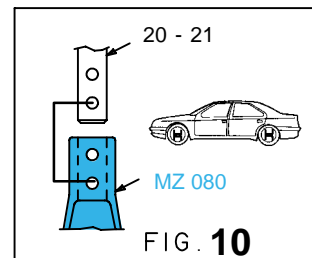
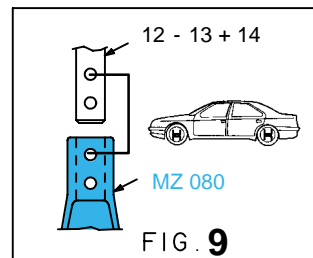
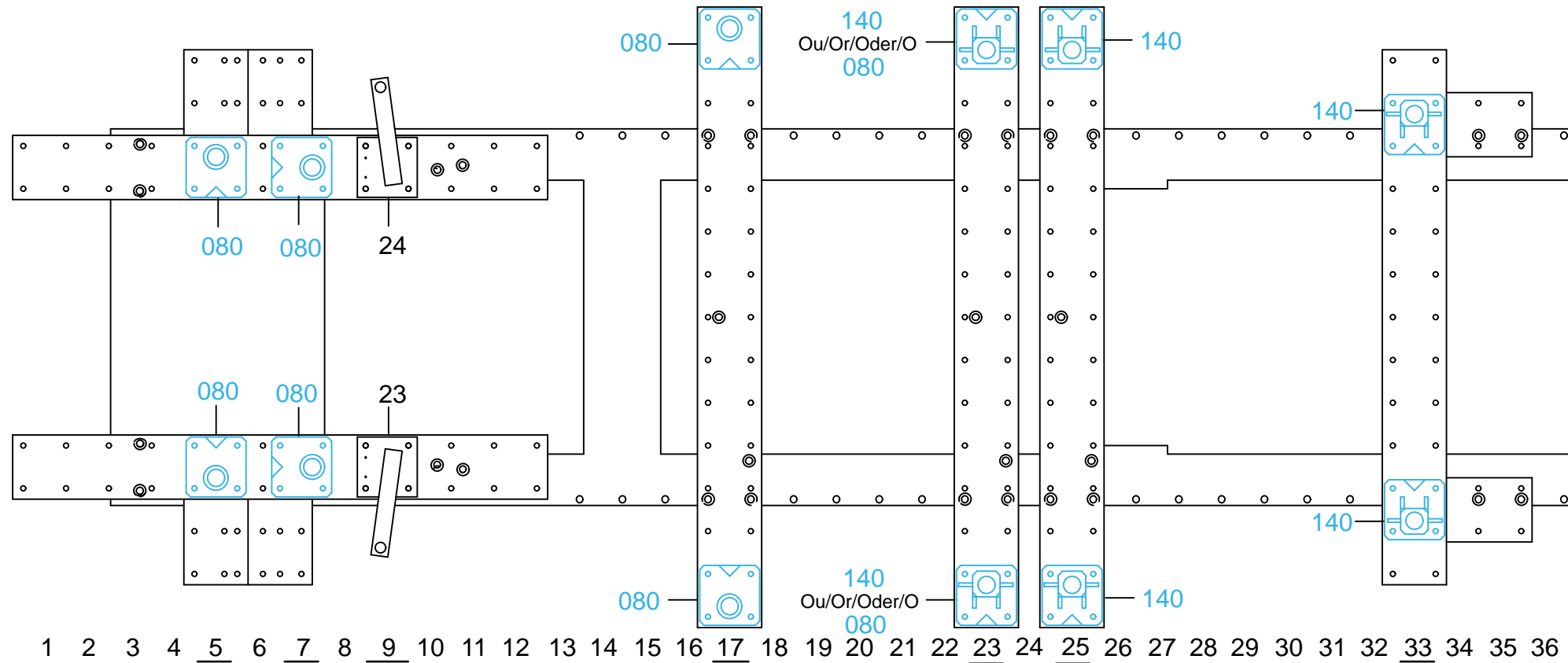

○ Avec ou sans mécanique
 With or without mechanical elements
 Con o senza parti meccaniche
 Mit oder ohne Aggregate
 Con ó sin mecánica desmontada



2035.307

6 Kg	14.06.2004	431-D-8D
2035.307 - RVA3-2		00