

○ Avec ou sans mécanique  
 With or without mechanical elements  
 Con o senza parti meccaniche  
 Mit oder ohne Aggregate  
 Con ó sin mecanica desmontada

REP.	REFERENCE	PDS	NB	MZ
67	2010.7067	2,8	1	142
68	2010.7068	2,8	1	141

complément au  
 complementary set to  
 complemento al  
 zusatz zu

**2035.300 +  
 2035.307**

Ou/Or/Oder/O

**2010.300 +  
 2010.309 +  
 2035.307**

**2035.306**



6 Kg	31.10.2007	431-D-9A
2035.306-RVA3-1		00

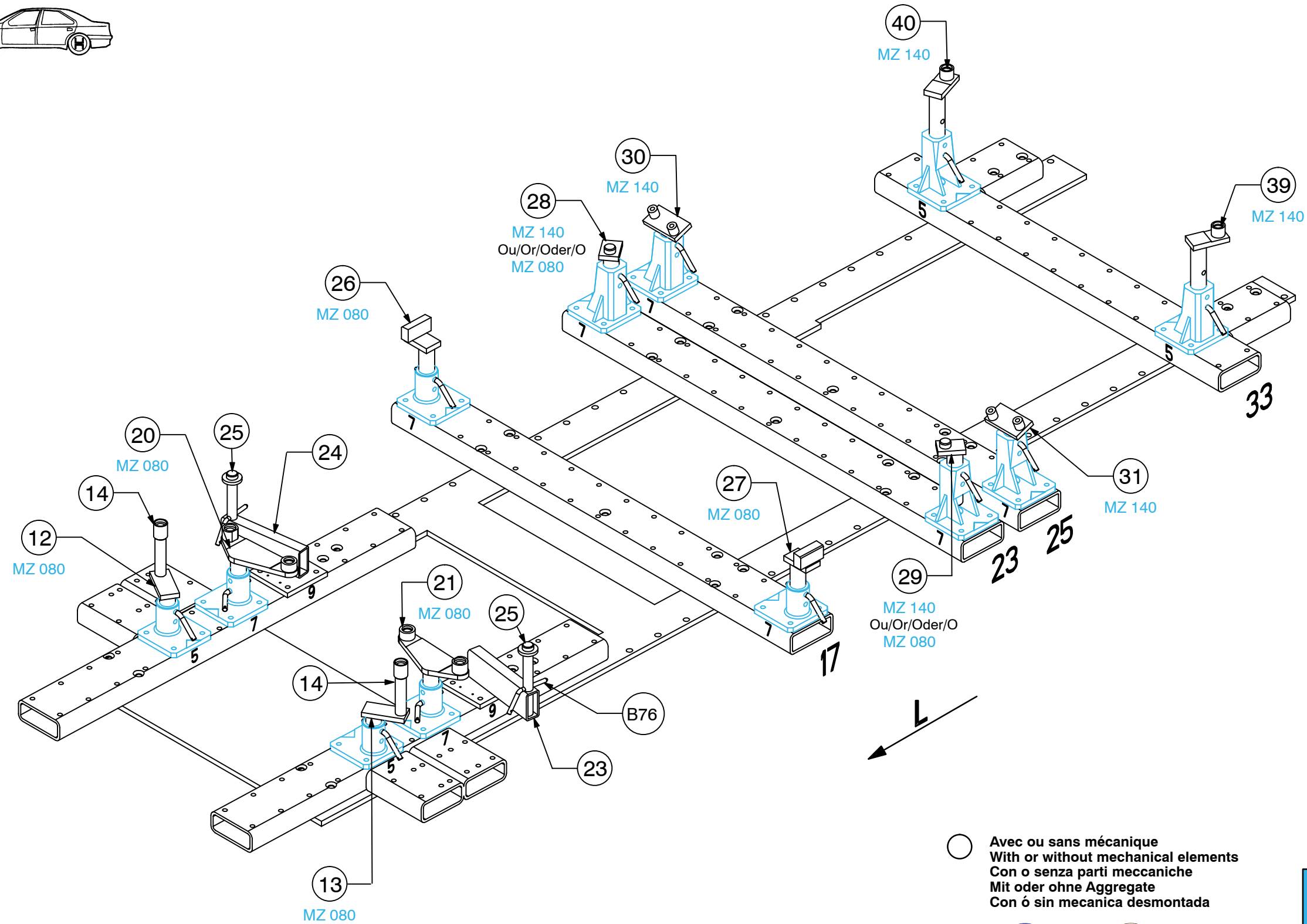
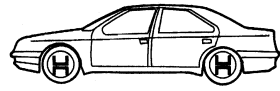

○ Avec ou sans mécanique  
 With or without mechanical elements  
 Con o senza parti meccaniche  
 Mit oder ohne Aggregate  
 Con ó sin mecanica desmontada

**2035.306**

6 Kg	31.10.2007	431-D-9B
2035.306 - RVA3 - 1		00

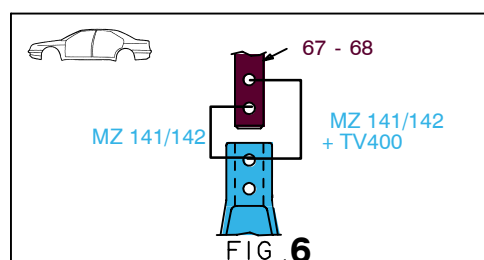
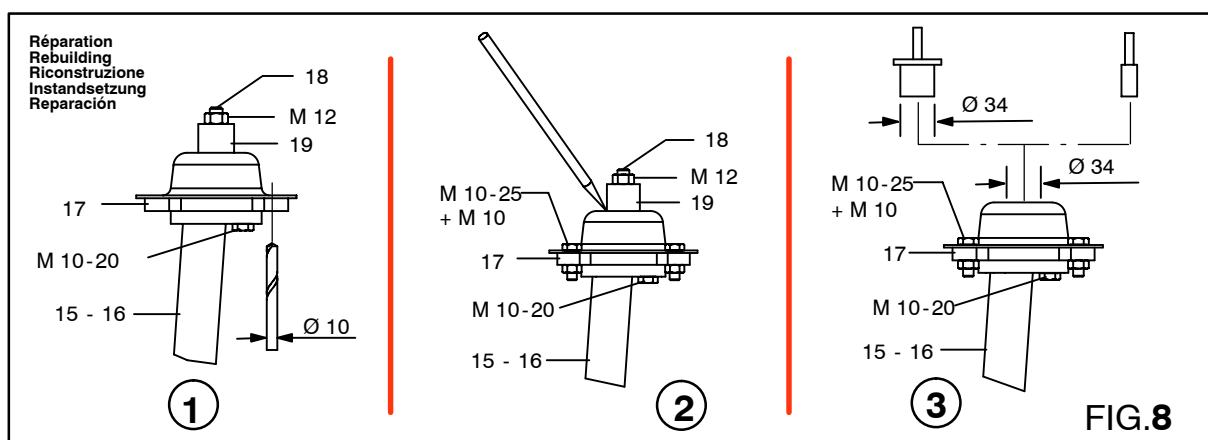
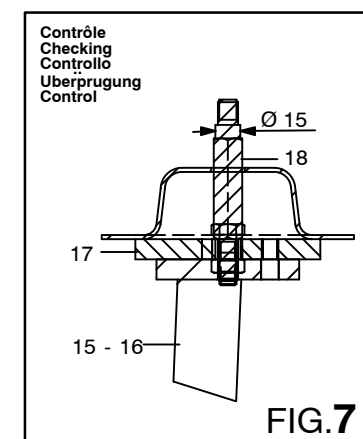
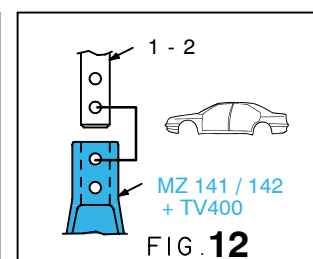
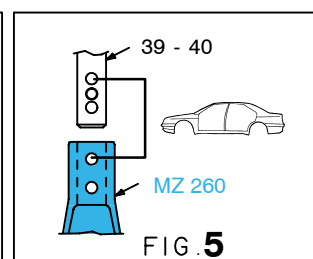
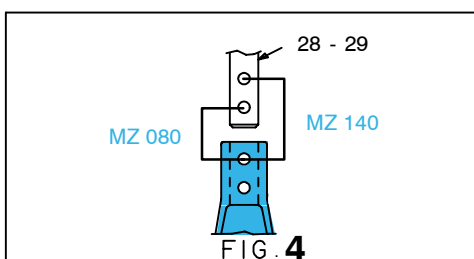
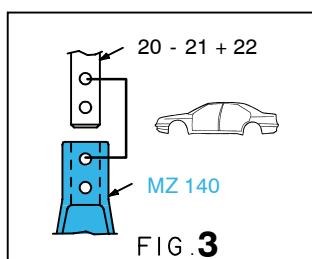
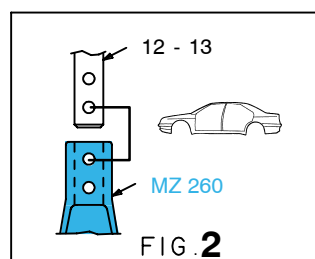
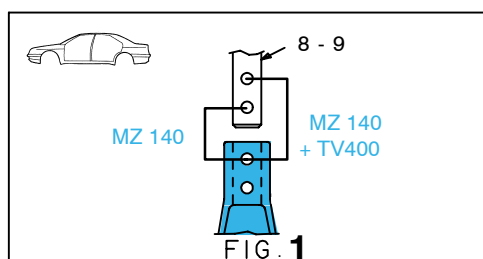
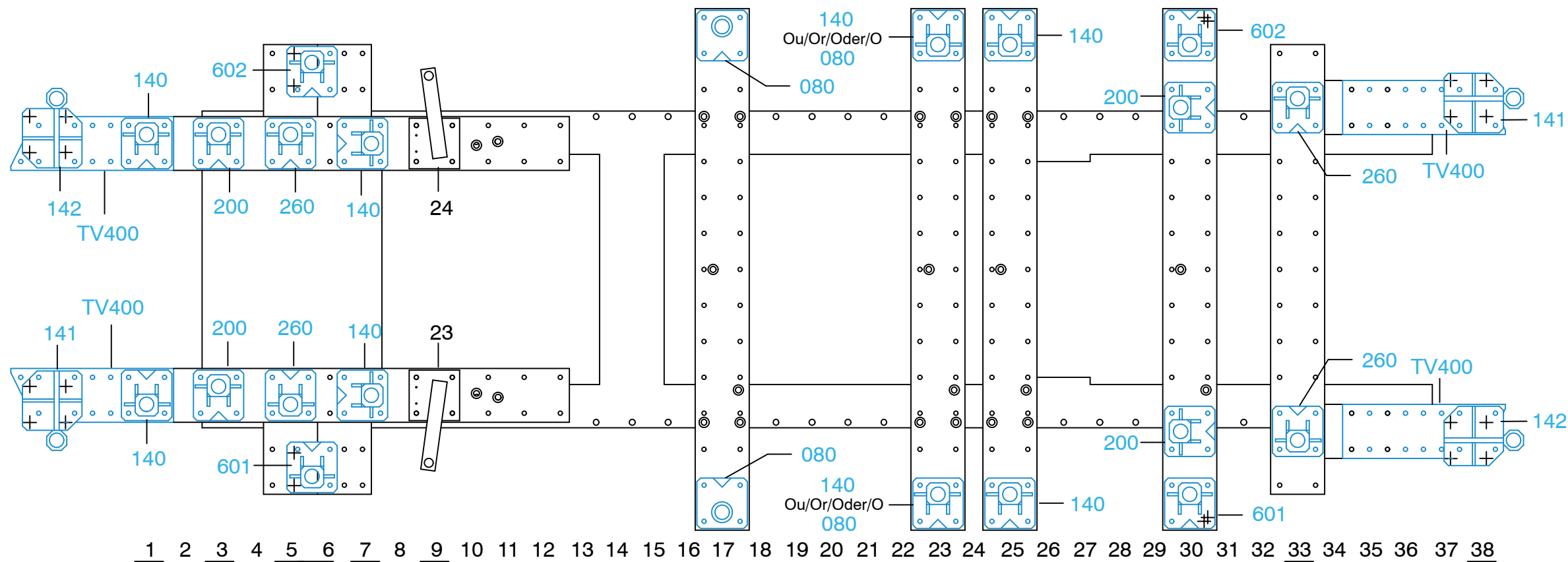
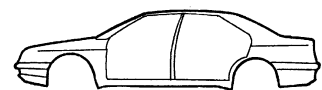

○ Avec ou sans mécanique  
 With or without mechanical elements  
 Con o senza parti meccaniche  
 Mit oder ohne Aggregate  
 Con ó sin mecanica desmontada



<b>2035.306</b>		
6 Kg	31.10.2007	431-D-9C
2035.306-RVA3-2		00

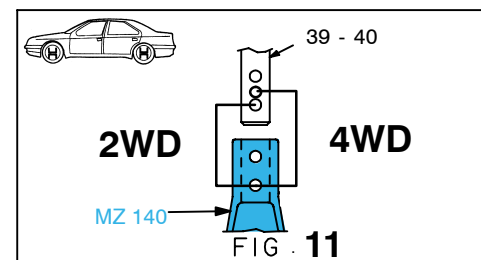
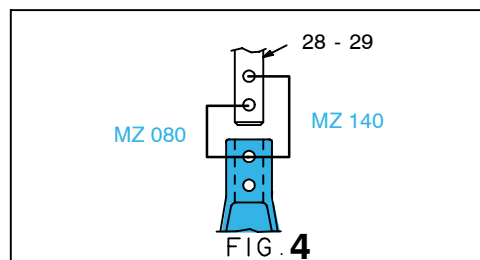
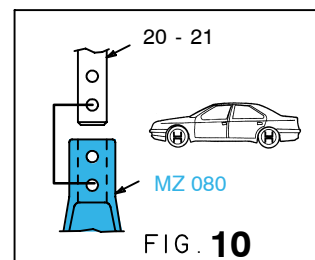
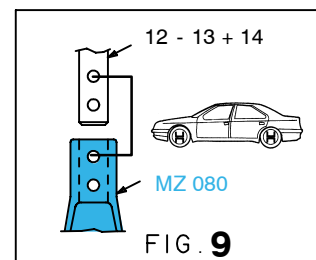
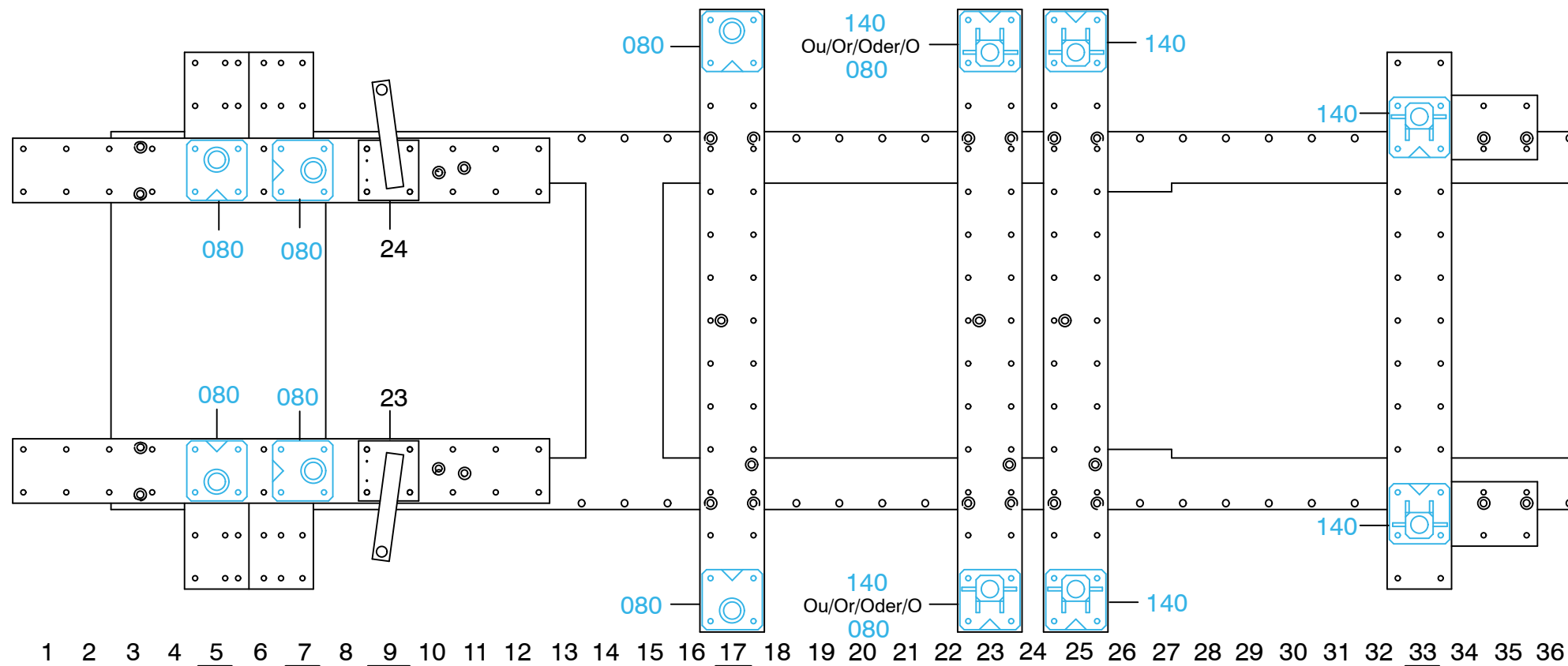
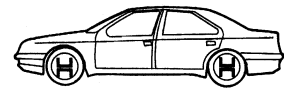

○ Avec ou sans mécanique  
 With or without mechanical elements  
 Con o senza parti meccaniche  
 Mit oder ohne Aggregate  
 Con ó sin mecanica desmontada



**2035.306**

6 Kg	31.10.2007	431-D-9D
2035.306 - RVA3-2		00