

VAS 6240/5



REP.	REFERENCE	PDS	NB	MZ
50	2010.7050	3,4	1	141
51	2010.7051	2,8	1	142

M 8-25 4

complément au
complementary set to
complemento al
zusatz zu

2035.300
Ou/Or/Oder/O
2010.300 +
2010.309 +
2010.308

2035.305

7 Kg 30.05.2007 438-D-28E

2035.305 - RVA3-1 00

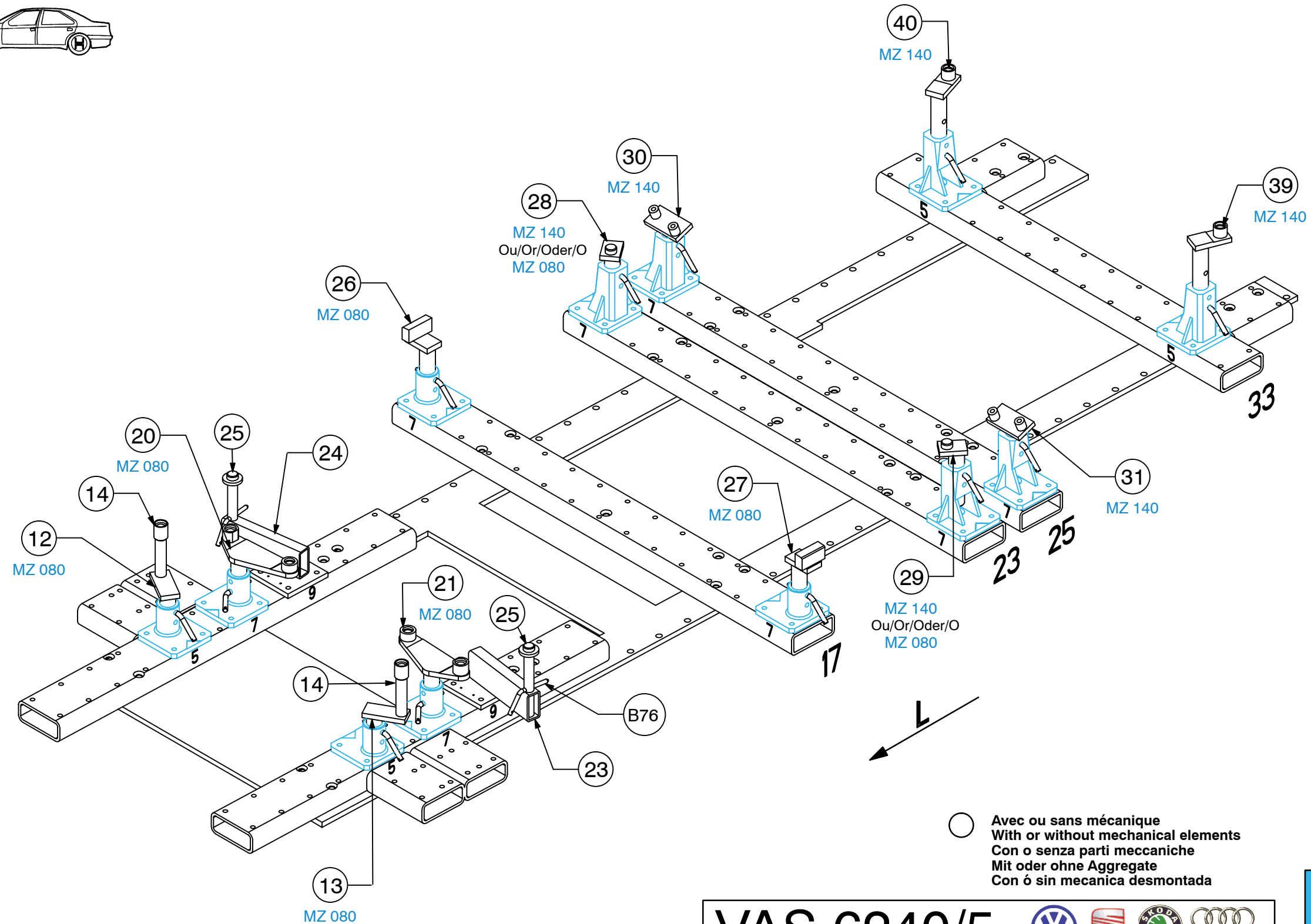
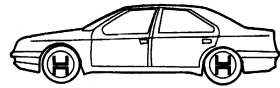

○ Avec ou sans mécanique
With or without mechanical elements
Con o senza parti meccaniche
Mit oder ohne Aggregate
Con ó sin mecanica desmontada



VAS 6240/5



2035.305

7 Kg	30.05.2007	438-D-28F
2035.305 - RVA3 - 1		00

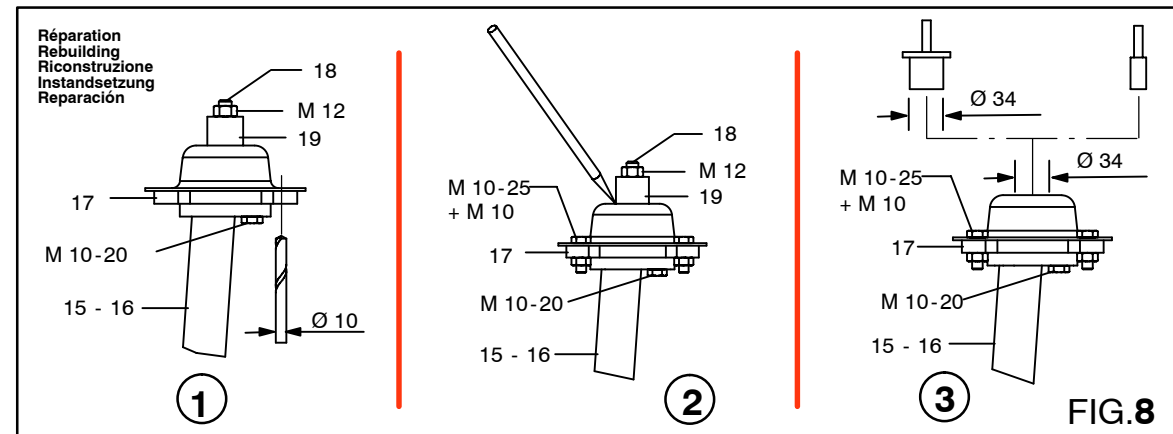
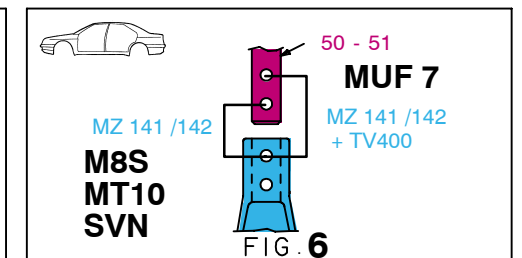
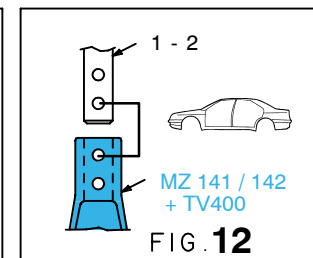
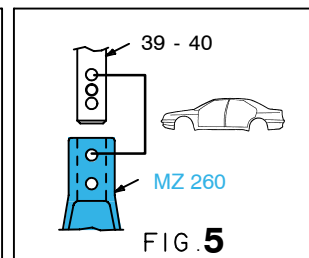
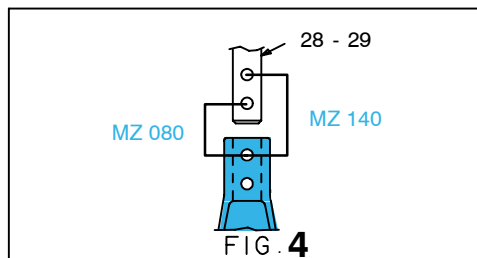
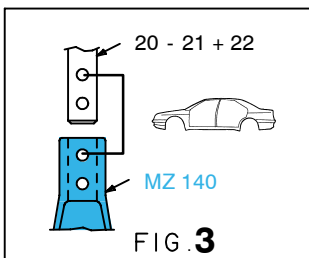
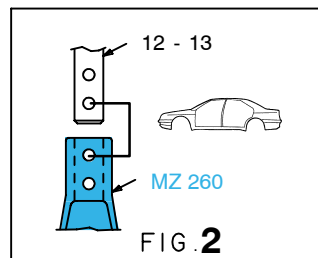
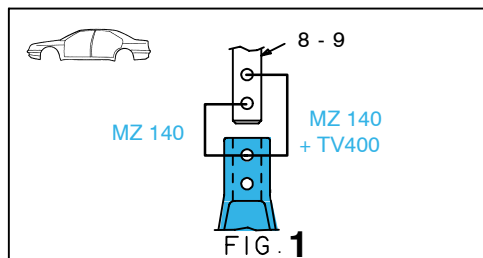
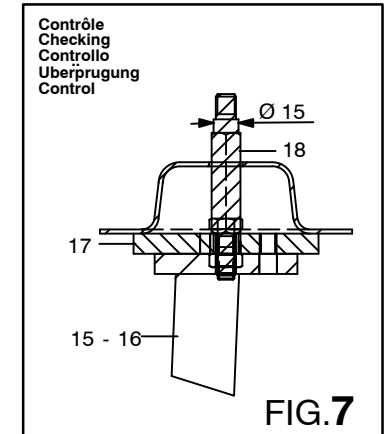
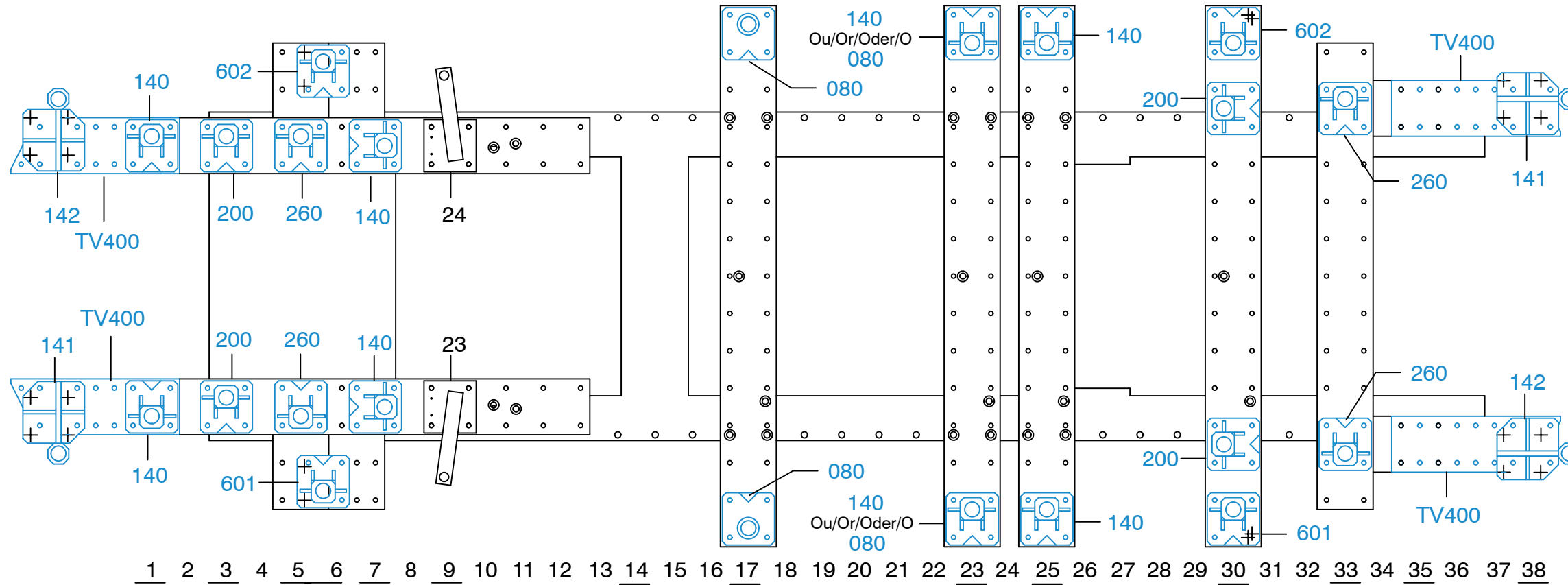
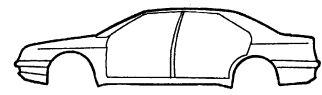

○ Avec ou sans mécanique
With or without mechanical elements
Con o senza parti meccaniche
Mit oder ohne Aggregate
Con ó sin mecanica desmontada

VAS 6240/5



2035.305

7 Kg | 30.05.2007 | 438-D-28G

2035.305 - RVA3-2 | 00



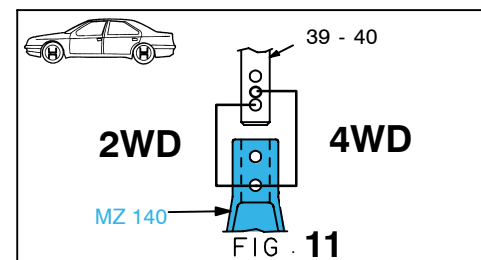
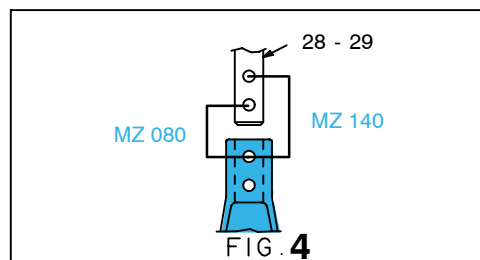
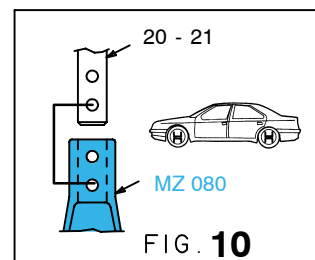
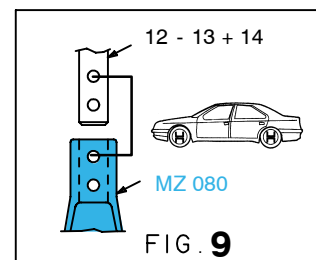
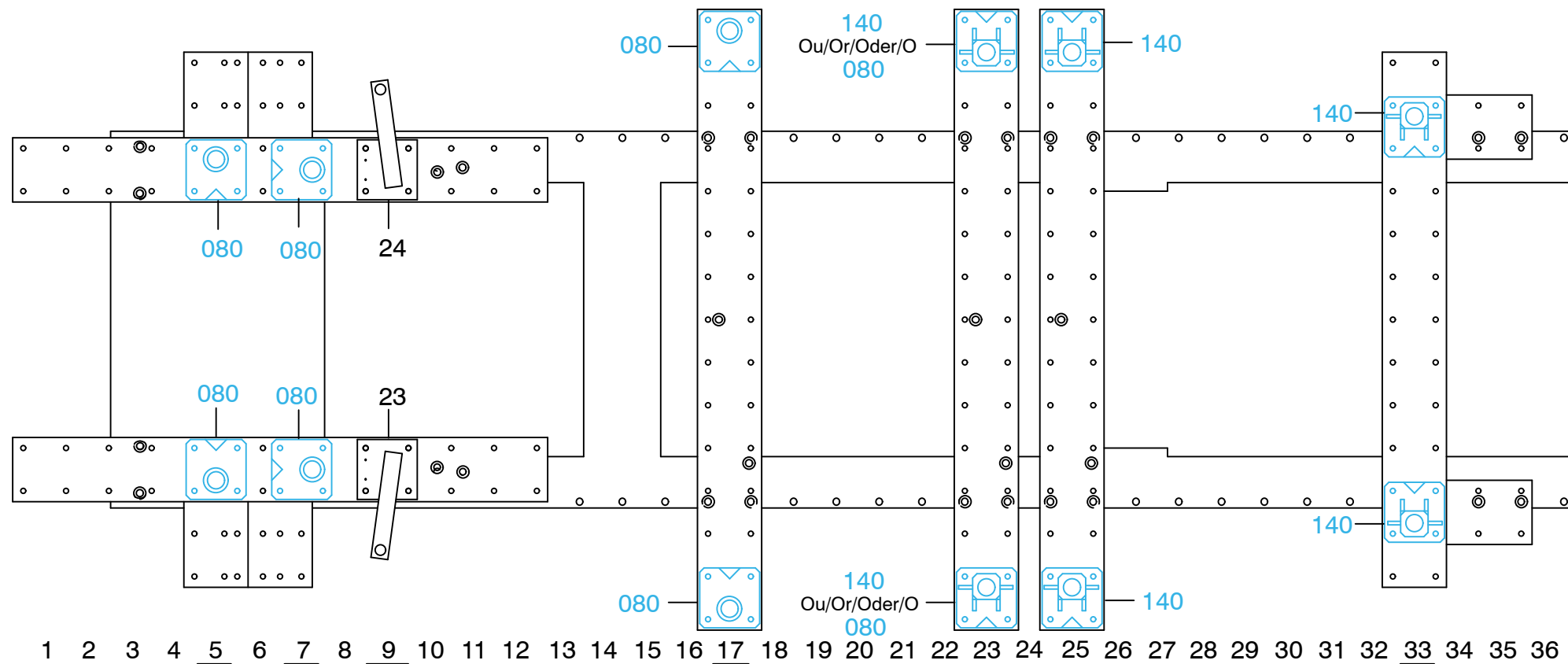
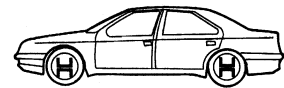

○ Avec ou sans mécanique
 With or without mechanical elements
 Con o senza parti meccaniche
 Mit oder ohne Aggregate
 Con ó sin mecánica desmontada



VAS 6240/5



2035.305

7 Kg	30.05.2007	438-D-28H
2035.305 - RVA3 - 2		00